

PADERNO[®]



WORLD CUISINE

PARTNER OF THE BEST CUISINE

CATALOGUE

2024





PARTNER OF THE BEST CUISINE

With over 90 years of history and a worldwide presence, Paderno is the benchmark for the professional catering industry and for every cooking enthusiast.

More than 10.000 items, **a complete range for every need in the kitchen**, dedicated to chefs and passionate gourmands. In addition to the production items, the brand offers a remarkable range of complementary articles, carefully selected, and crafted by highly qualified companies.

Forte di oltre 90 anni di storia e di una presenza capillare in tutto il mondo, Paderno è il punto di riferimento per il settore della ristorazione professionale e per ogni appassionato di cucina.

Oltre 10.000 prodotti, **una gamma completa per ogni esigenza in cucina**. Le linee di strumenti Paderno sono ideate per unire praticità d'utilizzo a efficienza e stile. Agli articoli di produzione il brand affianca un'importante gamma di prodotti complementari e affini, accuratamente selezionati e realizzati da ditte altamente qualificate.

PADERNO[®]



WORLD CUISINE

OUR HISTORY

1925

THE ESTABLISHMENT LA FONDAZIONE

The company was established in 1925 in Paderno Dugnano, a few kilometers from Milan. The brand, then known as Alluminio Paderno, specialized in **home cooking and aluminum cookware.**

Il brand trova le sue origini nel 1925 a Paderno Dugnano, a pochi km da Milano. L'azienda, allora nota come Alluminio Paderno, si specializza nel settore della **cucina casalinga e del pentolame in alluminio.**

Orfengo Headquarter, opened in 1997





1979

FOCUS ON PROFESSIONALS
AL SERVIZIO DEI PROFESSIONISTI

During the 1970s, the company was taken over by the entrepreneurial brothers Pierluigi and Franco Coppo. Improved production and quality standards ensured a wide and varied offer. The company is relaunched and **emerges in the hotel market** and catering supplies.

Durante gli anni '70 l'azienda viene acquisita dai fratelli imprenditori Pierluigi e Franco Coppo. Migliorando gli standard di produzione e qualitativi viene così garantita un'ampia e variegata offerta. L'azienda viene rilanciata ed **emerge nel mercato alberghiero** e delle forniture per la ristorazione collettiva.

Our partner Alfredo Russo, Michelin-starred chef



OUR HISTORY

1997

-

1999

THE NEW HEADQUARTER IL NUOVO QUARTIER GENERALE

In 1997, Paderno acquired Sambonet - a historic brand of cutlery and table accessories - and in 1999 the new headquarters and production plant was inaugurated. An **eco-friendly architecture**, harmoniously set in nature, designed by architect Enrico Frigerio.

Nel 1997 Paderno acquista Sambonet - storico marchio di posate e accessori tavola - e nel 1999 viene inaugurata la nuova sede e stabilimento produttivo. **Un'architettura ecocompatibile** inserita armoniosamente nella natura, disegnata dall'architetto Enrico Frigerio.



2006

AWARD FOR EXCELLENCE PREMIO ECCELLENZA

Sambonet Paderno Industrie S.p.A. received the **Award for Excellence for Innovation** by Confindustria (the main organization representing Italian manufacturing and services companies) with reference to the framework for innovation of the EFQM–European Foundation for Quality Management.

Sambonet Paderno Industrie S.p.A. è stata insignita dell'**Award for Excellence per l'innovazione**, rilasciato da Confindustria in riferimento al framework per l'innovazione dell'EFQM–European Foundation for Quality Management.



2009
-
2015

ARCTURUS GROUP
IL GRUPPO ARCTURUS

In 2009, Sambonet Paderno Industrie acquired the prestigious German porcelain brand Rosenthal, followed by the Bavarian Arzberg in 2013 and the French Ercuis and Raynaud in 2015. Thanks to the entrepreneurship of brothers Pierluigi and Franco Coppo, the **Arcturus group is now an international leader** in the dining, kitchen, and home living business.

Nel 2009 Sambonet Paderno Industrie acquisisce il prestigioso brand di porcellane tedesco Rosenthal, cui segue la bavarese Arzberg nel 2013 e le francesi Ercuis e Raynaud nel 2015. Grazie all'imprenditorialità dei fratelli Pierluigi e Franco Coppo, il **Gruppo Arcturus è oggi leader internazionale** nel mondo tavola, cucina e home living.

Pierluigi, Alessandra, Giovanni and Franco Coppo



GREEN & SUSTAINABILITY

SUSTAINABILITY, TRANSPARENCY AND AWARENESS ARE KEYWORDS OF OUR CORPORATE RESPONSIBILITY.

SOSTENIBILITÀ, TRASPARENZA E CONSAPEVOLEZZA SONO LE PAROLE CHIAVE DELLA NOSTRA POLITICA DI CORPORATE RESPONSIBILITY.

CLEAN ENERGY ENERGIA PULITA

In 2022 we activated the new zero-impact solar photovoltaic system, installed on the roof of our factory. **More than 3,000 panels on 6,000 sqm.** The plant can generate an average of 1,250 KW, equal to 30% of the company's annual needs. The plant cuts CO2 emissions into the environment consistently, **the equivalent of 7,500 planted trees in 5 years.** A small but significant contribution to our planet.

Nel 2022 abbiamo attivato il nuovo impianto fotovoltaico a energia solare a impatto zero, installato sulla copertura dello stabilimento. **Oltre 3.000 pannelli su una superficie di 6.000 m².** L'impianto è in grado di generare mediamente 1.250 KW, ossia il 30% del fabbisogno energetico annuo dell'azienda. Lo stabilimento diminuisce così le emissioni di CO2 nell'ambiente in maniera considerevole: **il corrispettivo di 7.500 alberi piantati nell'arco di soli 5 anni.** Un piccolo ma significativo contributo per il nostro pianeta.



10 YEARS OF SUSTAINABILITY REPORT 10 ANNI DI BILANCIO DI SOSTENIBILITÀ

Since 2012 we have published the Sustainability Report every year, a report on our performance through numbers and achieved targets, **a concrete proof of our commitment** and attention to sustainable development.

Dal 2012 pubblichiamo ogni anno il Bilancio di sostenibilità, un report delle nostre performance attraverso numeri e obiettivi raggiunti, **testimonianza concreta del nostro impegno** e attenzione verso uno sviluppo sostenibile.



RESPONSIBLE CONSUMPTION CONSUMO RESPONSABILE

We care about our planet and that is why we set our environmental policy on a responsible consumption and the use of clean and renewable energy sources. **A sustainable and respectful approach to nature** and our territory.

Abbiamo a cuore il nostro pianeta e per questo abbiamo impostato la nostra politica ambientale sul consumo responsabile e sull'utilizzo di fonti energetiche pulite e rinnovabili. **Un approccio sostenibile e rispettoso per la natura** e il nostro territorio.



OUR EFFORTS, EVERY DAY IL NOSTRO IMPEGNO, TUTTI I GIORNI

Beside monitoring water consumption and purification systems, we use energy-efficient LED lighting elements, twilight lamps throughout the plant and controlled thermostats in every office. We have reduced paper consumption by choosing digital archiving, using recyclable materials and separate waste collection in every room. **This is non-stop progress.**

Oltre al monitoraggio del consumo d'acqua e sistemi di purificazione, impieghiamo elementi di illuminazione LED ad alta efficienza energetica, crepuscolari in tutto lo stabilimento e termostati controllati in ogni ufficio. Abbiamo ridotto il consumo di carta scegliendo l'archiviazione digitale, impiegando materiali riciclabili e operando la raccolta differenziata in ogni ambiente. **Un miglioramento non-stop.**

FACTORY

NATURE meets DESIGN

ITALIAN HEADQUARTERS

In 2001, in 9 months, the new headquarter between Vercelli and Novara was built, amounting to 150,000 square meters - equivalent to more than 20 football fields - of which 19,000 square meters for production. In 2004, the new warehouse was expanded to 13,000 square meters, later still to 25,000 square meters. The building - which includes one of the largest galvanic plants in Europe - **meets all production and warehouse requirements, as well as logistics needs**. It is positioned exactly opposite the highway entrance for fast connections to the center of northern Italy.

Developed by the Frigerio Design Group, Slow Architecture is a progressive architecture, living in time and in its context. The parallelism created by the building establishes a geometric correspondence between the Po Valley and the linearity of the façade elevation, which is sensitive to the nuances of the sky and the land through an unprecedented play of colours, with a "screen" of gigantic colored pixels.

Nel 2001, in 9 mesi, viene costruito il nuovo headquarter tra Vercelli e Novara, pari a 150.000 m² - equivalenti a oltre 20 campi da calcio - di cui 19.000 m² di produzione. Nel 2004 viene ampliato il nuovo magazzino a 13.000 m², successivamente ancora a 25.000 m². Lo stabilimento - che include uno degli impianti galvanici più grandi d'Europa - **risponde a tutte le esigenze di produzione e stoccaggio, oltre che di logistica**, posizionato esattamente di fronte all'ingresso autostrale per rapidi collegamenti con il cuore nevralgico del Nord Italia.

Sviluppata dal Frigerio Design Group, la Slow Architecture è un'architettura progressiva, che vive nel tempo e nel contesto in cui s'inserisce. Il parallelismo creato dal nuovo edificio instaura una corrispondenza geometrica tra la Pianura Padana e la linearità del prospetto della facciata, sensibile alle sfumature del cielo e del territorio attraverso un inedito gioco cromatico, con uno "schermo" di enormi pixel colorati.

US HEADQUARTERS

In 2020, the new centralized logistics hub Sambonet Paderno in Randolph, New Jersey was opened. **A key distribution hub in North America**, covering over 6.000 square meters, with 40 employees, sales offices, and a state-of-the-art warehouse with more than 15.000 products.

Nel 2020 è stato inaugurato il nuovo polo logistico centralizzato Sambonet Paderno a Randolph, New Jersey. **Una struttura chiave per la distribuzione dal Nord America**, che si sviluppa su 6.000 m² e riunisce un organico di 40 dipendenti, uffici commerciali e un magazzino di ultima generazione che ospita oltre 15.000 prodotti.

90 EXPORT COUNTRIES

800 SHIPMENTS PER DAY

20.000 KG CHECKED PER DAY

3 CHECKS BEFORE EACH SHIPMENT

17.000 REFERENCES IN STOCK

87 SHIPMENTS WITHIN 48 HOURS FROM THE ORDER

20.000 PIECES PRODUCED PER DAY

40 MODELS OF CUTLERY

5.000 CUTLERY MOLDS

5.000 POTS PRODUCED PER DAY

CERTIFIED QUALITY

ENERGY & GREEN CERTIFICATIONS

Sustainable development and low environmental impact. We adopt **clean and renewable energy sources** such as methane and electricity – as the new photovoltaic system – and resources to be returned to the environment completely intact – as in the case of the groundwater used in our factory, which is constantly analysed and monitored by our in-house laboratory.

Uno sviluppo sostenibile e impatto ambientale contenuto. Adottiamo **fonti energetiche pulite e rinnovabili** quali metano ed elettricità – come per il nuovo impianto fotovoltaico – e risorse da restituire all'ambiente completamente integre – come nel caso dell'acqua di falda impiegata nel nostro stabilimento, analizzata e monitorata costantemente dal nostro laboratorio interno.



HUMAN & SAFETY CERTIFICATIONS

We define and keep updated **high safety standards in favor of our employees** and the entire working environment, also going beyond the regulations, according to a long-term projection that is indispensable in our Group vision. This policy is widespread in all our production sites and in 2016 it let us earn a special mention from Confindustria and INAL Italia, for the promotion of "Total Safety Management".

Definiamo e aggiorniamo **elevati standard di sicurezza a favore dei nostri dipendenti** e dell'intero ambiente di lavoro, andando anche oltre alle normative vigenti in materia, secondo una proiezione di lungo termine indispensabile nella nostra visione di Gruppo. Questa politica è diffusa in tutti i nostri siti produttivi e già nel 2016 ci è valsa una gratificante menzione speciale da parte di Confindustria e INAL Italia, per la promozione del "Total Safety Management".



FOOD, PRODUCTION & SHIPPING CERTIFICATIONS

Our products are safe for food contact thanks to **quality requirements observed along the entire supply chain**. From the application of HACCP to the hygienic-sanitary regulations established by the highest international standard, up to packaging in compliance with customs standards, for **fast shipping and delivery**.

Ogni nostro prodotto è sicuro per il contatto alimentare grazie a **requisiti qualitativi tracciati lungo l'intera filiera**. Dall'applicazione dell'HACCP alle normative igienico-sanitarie stabilite dal più alto standard internazionale, fino anche all'imballaggio in rispetto agli standard doganali, per una **rapida spedizione e consegna**.





LAB CERTIFICATIONS



LAB N°1407

Thanks to our certified Accredia laboratory, ASEC Lab – Alimentary Security Control, **we can guarantee the suitability and safety of each of our articles** placed on the market, both direct and distributed. We can also issue conformity declarations on steel, aluminum, porcelain, glass, plastic, and colorants internationally recognized. The ASEC Lab is also accredited to determine pH levels, solvents and metals in water discharge, a guarantee for the internal analysis of the wastewater quality.

Grazie al nostro laboratorio certificato Accredia, ASEC Lab – Alimentary Security Control, **siamo in grado di garantire l'idoneità e la sicurezza di ciascun nostro articolo** immesso sul mercato, sia di produzione diretta che distribuito. Siamo inoltre autonomi per il rilascio di dichiarazioni di conformità su acciaio, alluminio, porcellana, vetro, materiali plastici e coloranti, riconosciute a livello internazionale. ASEC Lab è inoltre accreditato per la determinazione di pH, solventi e metalli nelle acque scarico, una garanzia per le analisi interne sulla qualità delle proprie acque di scarico.

SR:10 SOCIAL RESPONSIBILITY



Thanks to the Corporate Social Responsibility requirements we have pursued over the years and the commitment required also from international suppliers and partners, we are now able to offer **guarantees to our stakeholders**, customers, employees, the market, the community, and the territory as well as institutions and authorities. It means further protection in respect of the common interests and in consideration of the principles of legality and protection of human rights.

Grazie ai requisiti perseguiti negli anni in ambito di Responsabilità Sociale d'Impresa e l'impegno richiesto anche a fornitori e intermediari con i quali lavoriamo in ambito internazionale, siamo oggi in grado di offrire **garanzie oggettive ai nostri stakeholder**, a clienti, dipendenti, al mercato, alla comunità e al territorio fino a enti e istituzioni. Una tutela ulteriore nel rispetto dei loro dell'interesse di tutti e in considerazione dei principi di legalità e salvaguardia dei diritti umani.

EMPLOYEE WELFARE BENESSERE DEI DIPENDENTI



Becoming one of the pioneers in the area, we have joined the European WHP Network (Workplace Health Promotion) to spread the importance of protecting the psychophysical health, through the **promotion of a wholesome lifestyle mentally, physically, and emotional**. We proactively work to offer our employees purchase agreements for goods and services and facilitations for reconciliation of professional and personal life.

Affermandoci tra i pionieri del territorio, siamo entrati a far parte della Rete Europea WHP (Workplace Health Promotion) per diffondere al nostro interno l'importanza e salvaguardia della salute psicofisica, con la **promozione di uno stile di vita corretto in ambito alimentare, sportivo ed emotivo**. Ci adoperiamo proattivamente per offrire ai nostri dipendenti convenzioni per acquisti di beni e servizi e agevolazioni per conciliazione tra vita professionale e personale.

FOLLOW US





M A D E T O S H I N E

Paderno has always been by professionals' side, so that the "star" in each of them can finally "shine". This is the philosophy behind the new brand communication campaign. Every day in the kitchen is a challenge, in which you must manage space, time and tools. **Paderno Made to Shine reveals the magic of those moments**, with a flawless cooking performance by a Michelin-starred chef or with the show by a flair bartender during a mixology event.

Paderno è da sempre al fianco di tutti professionisti, affinché la "stella" presente in ciascuno di loro possa finalmente "splendere". Questa la filosofia dalla quale prende vita la nuova campagna di comunicazione del marchio. In cucina ogni giorno è una sfida, nella quale occorre gestire spazi, tempi e strumenti. **Paderno Made to Shine svela la magia di quei momenti**, dalla rigorosa performance ai fornelli di uno chef stellato, allo spettacolare show di un barman acrobatico durante un evento mixology.

WINNER
INTERACTIVE KEY AWARD 2022
VIDEO "MADE TO SHINE" B2B

SCAN QR CODE



www.paderno.it



AT YOUR SERVICE



ITALIAN SHOWROOM

A new, functional, and welcoming showroom is open at the Orfengo site, Italy. Not only does it illustrate the product range at its best, it also provides inspiration on set-ups and allows you to 'touch' the quality of Sambonet Paderno Industrie. Ask for an appointment to schedule a visit.

Nella sede di Orfengo è attivo **un rinnovato spazio espositivo, funzionale e accogliente**. Ambienti che illustrano al meglio non solo la gamma di prodotti, ma offrono ispirazione sugli allestimenti e permettono di "toccare con mano" la qualità di Sambonet Paderno Industrie. Richiedi un appuntamento per fissare una visita.



ARCTURUS LAB IN MILAN

In November 2022, the Group inaugurated its new showroom in the Bovisa area, redeveloping the old Officine Coppo - the place where the roots of Arcturus' history lie. **A showroom intended to meet the international clientele**, and where professionals, designers and architects can give life to kitchen and table projects, especially for the Contract sector.

A novembre 2022 il gruppo inaugura il nuovo showroom in zona Bovisa, riqualificando le antiche Officine Coppo - luogo in cui risiedono le radici della storia di Arcturus. **Uno spazio espositivo destinato a ricevere la clientela internazionale**, e dove professionisti, designer e architetti possono dare vita a progetti cucina e tavola, in particolare destinato al Contract.

MIAMI SHOWROOM

Still in Novembre 2022 coinciding with Miami Design Week, the US subsidiary is inaugurating an exclusive showroom located in the 'Magic City', the heart of the State of Florida. Approximately 250 sqm where all the Arcturus brands are displayed by a wide selection of table and kitchen range. A vibrant place where chefs, food & beverage managers, architects and interior designers can create **new tailor-made projects, focused on Hospitality and Contract sector**. A reference point also for cruise lines and the Caribbean market.

Sempre a novembre 2022 in occasione della Miami Design Week, la filiale USA inaugura un esclusivo spazio espositivo situato nella cosiddetta "Magic City", cuore pulsante dello stato della Florida. Circa 250 mq dove tutti i brand di proprietà Arcturus sono rappresentati da una ampia selezione di prodotti tavola e cucina, un luogo dinamico nel quale chef, food & beverage manager, architetti e interior designer possono dare vita **a nuovi progetti su misura per l'intero settore dell'Ospitalità e del Contract**. Un punto di riferimento anche per le compagnie di crociera e il mercato caraibico.

CUSTOMER SERVICE

We share our experts' experience at your disposal to help you design and implement the solution you are looking for.

Our staff is highly trained to follow every business need. Contact us and our customer service department will support you at all stages of the purchasing, tracking and after-sales process.

Mettiamo a tua disposizione l'esperienza dei nostri esperti per aiutarti a progettare e realizzare la soluzione che stai cercando.

I nostri collaboratori sono altamente formati per seguire ogni esigenza commerciale. Contattaci e la nostra rete di assistenza ti supporterà al meglio in tutte le fasi del processo di acquisto, tracciabilità e post-vendita.

DIGITAL TRANSFORMATION

We adopted a technology infrastructure for enhanced product information management. Still and images, material description, size and product details: **a comprehensive database of content, accurate and ready for every channel.** Available to partners and customers through a quick and easy online search and download tool.

Abbiamo adottato un'infrastruttura tecnologica per una gestione delle informazioni sui prodotti sempre più performante. Immagini scontornate e ambientate, informazioni sui materiali, misure e dettagli di prodotto: **un database completo di contenuti, accurati e pronti per ogni canale.** A disposizione di partner e clienti attraverso uno strumento online di ricerca e download, semplice e veloce.

INDEX



COOKWARE, POTS & PANS

Pentolame
Kochgeschirr
Batteries de cuisine
Baterías de cocina

22



GN FOOD PANS

Contentitori GN
GN-Behälter
Bacs GN
Cubetas GN

74



KITCHEN UTENSILS

Utensili da cucina
Küchenzubehöre
Ustensiles de cuisine
Utensilios de cocina

101



KNIVES

Coltelleria
Kochmesser
Coutellerie
Cuchilleria

157



PASTRY UTENSILS

Pasticceria
Konditorei-Artikel
La pâtisserie
Pastelería

188



ETHNIC CUISINE

Cucina etnica
Ethnische Küche
Cuisine ethnique
Cocina étnica

276



BAR & ICE - CREAM

Bar e gelateria
Bar u. Eis-Artikel
Bar et glace
Bar y heladería

303



TABLE TOP SERVICE

Tavola
Tischservice
Service de table
Servicio de mesa

377



BUFFET DISPLAY & PRESENTATION

Buffet e presentazione
Buffet und Präsentation
Buffet et présentation
Presentación de buffet

462



CHAFING DISHES / TROLLEYS

Scaldavivande / Carrelli sala
Chafing dishes / Servicewagen
Chafing dishes / Chariots
Chafing dishes / Carros

501



STORAGE, TRANSPORT, CLEANING

Stoccaggio, trasporto, pulizia
Lagerung, Transport, Reinigung
Stockage, transport, nettoyage
Almacenamiento, transporte, limpieza

515



ELECTRIC APPLIANCES

Apparecchi elettrici
Elektrogeräte
Appareils électriques
Aparatos eléctricos

546

GLUTEN FREE - SPARE PARTS

Gluten Free - Ricambi
Glutenfrei - Ersatzteile
Gluten Free - Pièces de rechange
Gluten Free - Repuestos

567

INDEX & SALES TERMS

Indice e condizioni di vendita
Index und Verkaufsbedingungen
Index et conditions de vente
Índice y condiciones de venta

581

ICONS - SIMBOLOGIA - SYMBOLE - SYMBOLES - ICONOS

ABS	Copolymer, acrylonitrile-butadiene-styrene Copolimero, acrilonitrile-butadiene-stirene	PA+ <i>plus</i>	Polyamide (nylon 6.6) with fiberglass Poliammide (nylon 6.6) con fibra di vetro
AG	Silverplated Argentato	PR	Porcelain Porcellana
AQ PVD	Antique PVD	PC	Polycarbonate Policarbonato
AR	Natural slate Ardesia naturale	PE	Polyethylene Polietilene
AY	Acrylic Acrilico	PMMA	Polymethylmethacrylate, plexiglass Polimetilmetacrilato, plexiglas
B	Bamboo	PPE	Phenylene ether-expanded polypropylene Etere di polifenilene-polipropilene espanso
BC	Bone china	PP	Polypropylene Polipropilene
BPA FREE	Without bisphenol A Senza bisfenolo A	PS	Polystyrene Polistirene/polistirolo
FE	Metal Metallo	PVD	Physical vapor deposition Deposizione fisica da vapore
HDPE	High-density polyethylene Polietilene ad alta densità	R	Natural rattan Rattan naturale
MF	Melamine Melamina	SAN	Acrylonitrile-styrene copolymer Copolimero acrilonitrile-stirene
MS	Methylstyrene Metilstirene	SMMA	Styrene Methyl Methacrylate Stirene-metilmetacrilato
NEW	New Novità	SS	Stainless steel Acciaio inox
NSF	NSF certified Certificato NSF	VG	Vintage
PA	Polyamide (nylon) Poliammide (nylon)	VG PVD	Vintage PVD
		W	Wood Legno

ICONS - SIMBOLOGIA - SYMBOLE - SYMBOLES - ICONOS

	Suitable for electric stoves Adatto per fornelli elettrici		GN size Misure GN
	Suitable for glass-ceramic stoves Adatto per fornelli in vetroceramica		Battery powered Alimentato a batterie
	Suitable for induction stoves Adatto per fornelli a induzione		Hand wash Lavare a mano
	Suitable for gas stoves Adatto per fornelli a gas		Do not use sharp objects Non usare oggetti taglienti
	For gluten free food Per alimenti senza glutine		Do not use on open flames Non utilizzare su fiamme libere
	Coolable Refrigerabile		Dishwasher safe Lavabile in lavastoviglie
	Heated Riscaldato		No dishwasher safe Non lavabile in lavastoviglie
	Water resistant Resistente all'acqua		Microwave safe Idoneo a microonde
	NO water resistant NON resistente all'acqua		Oven safe Idoneo a forno
	With light Con luce		No microwave safe Non idoneo a microonde
	Food safe Per alimenti		No oven safe Non idoneo a forno
	Stackable Impilabile		Product that does not comply with the REACH Regulation Prodotto non conforme con la normativa REACH







SERIES 12200 5-PLY

STAINLESS STEEL COOKWARE
PENTOLAME INOX



Professional and elegant. Stainless steel stay-cool handles, mirror finish, designed to provide a secure and ergonomic grip. Securely attached to the pan with stainless steel rivets. The integral multilaminated body ensures rapid and uniform heating. Interior in 18/10 stainless steel satin finish, 3-ply aluminum core, induction stainless steel mirror finish exterior. Average thickness 2,7 mm. Suitable for use on all cooking hobs including induction.

Professionale ed elegante. Manici in acciaio inox finitura lucida, resistenti al calore e progettati per fornire una presa sicura ed ergonomica. Sono fissati saldamente ai corpi con rivetti in acciaio inossidabile. I corpi integralmente in multilaminato garantiscono un riscaldamento rapido e uniforme. Interno in acciaio inossidabile 18/10 satinato, anima in alluminio trilaminato, esterno in acciaio inossidabile per induzione con finitura a specchio. Spessore medio 2,7 mm. Adatta per l'uso su tutti i piani cottura compresa l'induzione.



Saucepan

Casseruola alta
Stielkasserolle
Casserole haute
Cazo recto alto

art.	Ø cm.	h. cm.	lt.
12206-16	16	8,0	1,4
12206-18	18	8,5	1,9
12206-20	20	10,0	2,8



Saucepot

Casseruola alta
Fleischtopf
Brasière
Cacerola alta

art.	Ø cm.	h. cm.	lt.
12207-24	24	14	5,9
12207-28	28	14	7,8



Sauté pan

Casseruola bassa
Stielkasserolle
Plat à sauter
Cazo recto bajo

art.	Ø cm.	h. cm.	lt.
12208-16	16	5,5	0,9
12208-20	20	7,0	1,8
12208-24	24	7,5	2,9
12208-28*	28	7,5	4,0

With loop handle. – Con contromaniglia.



Frypan

Padella
Bratpfanne
Poêle à frire
Sartén

art.	Ø cm.	h. cm.	lt.
12214-20	20	4,0	0,9
12214-26	26	4,5	1,7
12214-30	30	5,0	2,4
12214-36*	36	5,5	3,8

With loop handle. – Con contromaniglia.



Frypan non stick coated

Padella antiaderente
Bratpfanne Antihafbeschichtet
Poêle anti-adhérente
Sartén antiadherente

art.	Ø cm.	h. cm.	lt.
12217-20	20	4,0	0,9
12217-26	26	4,5	1,7
12217-30	30	5,0	2,4
12217-36*	36	5,5	3,8

With loop handle. – Con contromaniglia.



Oval baker

Tegame ovale
Ovaler Bräter
Plat ovale
Sartén ovalada

art.	dim. cm.	h. cm.	lt.
12238-30	30x18	5	1,4
12238-35	35x23	5	2,3



Lid

Coperchio
Deckel
Couvercle
Tapa

art.	Ø cm.
12261-16	16
12261-18	18
12261-20	20
12261-24	24
12261-28	28



SERIES 15600 3-PLY

COPPER COOKWARE
PENTOLAME RAME



Flagship show cooking tool and also ideal for cooking and serving from the kitchen to the table. Body made of three metals, copper, aluminum and steel. Thickness 2,5 mm. A mix for a homogenous and sweet thermal spread that ensures cooking without attacking the foods, preserving its nutritional properties and organoleptic characteristics. Inside stainless steel, practical and easy to clean. Middle layer aluminum, lightweight and a very good heat conductor. Exterior glossy copper finishing, a tradition in the kitchen, fascinating and beautiful to see. Cast stainless steel handles assembled with strong section stainless steel rivets. Suitable for use on all cooking hobs including induction.

Strumento di punta per lo show cooking e anche l'ideale per cucinare e servire dalla cucina alla tavola. Corpo formato da tre metalli, rame, alluminio e acciaio. Spessore 2,5 mm. Un mix per un'omogenea e dolce diffusione termica che assicura una cottura senza aggredire i cibi, preservandone le proprietà nutrizionali e le caratteristiche organolettiche. Lamina interna in acciaio inox, pratico e facile da pulire. Strato intermedio in alluminio, leggero e ottimo conduttore di calore. Esterno in rame finitura lucida, una tradizione in cucina, affascinante e bello da vedere. Manici e maniglie in acciaio inox assemblati con rivetti inox di forte sezione. Adatto ad uso su tutti i fuochi inclusa l'induzione.



Saucepan

Casseruola alta
Stielkasserolle, hoch
Casserole haute
Cazo recto alto

art.	Ø cm.	h. cm.	lt.
15606-16	16	8	1,6
15606-20	20	11	3,5
15606-24*	24	14	6,3
15606-28*	28	16	9,8

With loop handle. – Con contromaniglia.



Casserole pot

Casseruola bassa
Stielkasserolle, niedrig
Sautoir
Cacerola baja

art.	Ø cm.	h. cm.	lt.
15608-20	20	7	2,2
15608-24	24	8	3,6
15608-28*	28	9	5,5

With loop handle. – Con contromaniglia.



Frypan

Padella
Bratpfanne
Poêle à frire
Sartén

art.	Ø cm.	h. cm.	lt.
15614-20	20	4,0	1,2
15614-24	24	4,5	2,0
15614-28	28	5,0	3,0
15614-32*	32	5,5	4,4

With loop handle. – Con contromaniglia.



Saucepot

Casseruola alta
Fleischtopf
Brasière
Cacerola alta

art.	Ø cm.	h. cm.	lt.
15607-16	16	8	1,6
15607-20	20	11	3,5
15607-24	24	14	6,3
15607-28	28	16	9,8



Casserole pot

Casseruola bassa
Bratentopf
Sautoir
Cacerola baja

art.	Ø cm.	h. cm.	lt.
15609-20	20	7	2,2
15609-24	24	8	3,6
15609-28	28	9	5,5



French omelet pan

Tegame
Bratpfanne
Poêle à paella
Paellera

art.	Ø cm.	h. cm.	lt.
15615-20	20	4,5	1,4
15615-24	24	4,5	2,0
15615-28	28	5,5	3,4
15615-32	32	6,0	4,8



Lid

Coperchio
Deckel
Couvercle
Tapa

art.	Ø cm.
15661-20	20
15661-24	24
15661-28	28



COPPER/RAME SERIES 15300-15400
COMPLEMENTARY ITEMS - COMPLEMETARI

Complementary items in solid copper, thickness from 1,5 to 2,5 mm. The interiors are tinned over the fire by hand. Handles in highly polished solid brass, assembled with wide rivets. Suitable for use on any heating element (except on induction hob).

Articoli complementari in rame massiccio, spessore da 1,5 a 2,5 mm. Interno stagnato a mano sulla fiamma. Manici e maniglie in ottone massiccio lucidato a specchio ed assemblati con rivetti di forte sezione. Adatto ad uso su tutti i fuochi (eccetto induzione).



Oval saucepan
Casseruola ovale
Ovaler Bratentopf
Casserole ovale
Cacerola oval

art.	dim. cm.	h. cm.
15338-38	38x25	13



Bake roasting pan
Tegame rettangolare
Rechteckige Pfanne
Plat à four
Rustidera

art.	dim. cm.	h. cm.
15343-36	38x28	11



Oval pan
Tegame ovale
Ovale Bratpfanne
Plat ovale à poignées
Bandeja oval

art.	dim. cm.	h. cm.
15339-36	38x26	11



Fish kettle
Pesciera
Fischkochkessel
Poissonnière
Hervidor pescado

art.	dim. cm.	h. cm.
15438-50	50x18	11



Bain-marie with porcelain
Bagnomaria con porcellana
Wasserbadkasserolle mit Porzellan
Bain-marie avec porcelaine
Baño maría con porcelana

art.	Ø cm.	h. cm.
15403-16	16	17



Fondue set with porcelain
Set fonduta con porcellana
Fondue-Service mit Porzellan
Service à fondue avec porcelaine
Servicio fondue con porcelana

art.	Ø cm.	h. cm.
15430-11	16	26



Sugar saucepan
Casseruola per zucchero
Zuckerpfännchen
Poelon à sucre
Cacerola para azúcar

art.	Ø cm.	h. cm.
15406-16	16	9
15406-20	20	10



Zabaione bowl
Casseruola per zabaione
Zabaionekasserolle
Poelon à zabaione
Cacerola sabayón

art.	Ø cm.
15407-16	16
15407-20	20



Mixing bowl frosted finishing
Bastardella semisferica smerigliata
Schnees Schlagkessel mattiert
Bassine hémispherique givrée
Caldero esmerilado

art.	Ø cm.
15409-26	26
15409-30	30
15409-36	36



Set 3 pcs bordelais mould
Set 3 stampi scanalati
Bordelais-Kuchenform 3 Stk
Set 3 moules à cannelés Bordelais
Juego 3 moldes para bordelais

art.	Ø cm.	h. mm.
15415-03	5,5	5





MINI COOKWARE MINIATURE

COOKWARE
PENTOLAME



Small pots ideal for side dishes and individual servings, soufflés, baked pasta, rice creams, raclette, savory as well as sweet pastries, desserts, etc., etc.. Versatile, functional, ready to be served from the kitchen to the table. Original and yet traditional, they come from the world of haute cuisine, ideal for enhancing creations or the simplest recipes, for the sake of conviviality, to give a more playful aspect to our meals.

Una gamma di miniature ideali per contorni e singole porzioni, soufflé, pasta al forno, creme di riso, raclette, brioche salate e dolci, dessert, ecc., ecc.. Polivalenti, funzionali, pronte per essere servite dalla cucina alla tavola. Originali eppure tradizionali, provengono dal mondo dell'alta gastronomia, strumento ideale per valorizzare creazioni estrose o le più semplici ricette, per amore della convivialità, per donare un aspetto più ludico ai nostri pasti.



Paderno Serie 15600 3-ply, inside stainless steel satin polished, intermediate layer in aluminum, outside copper mirror polished. Thickness 2 mm. Stainless steel cast handles, stainless steel rivets. Suitable for use on any heating element (except on induction hob).

Serie Paderno 15600 3-ply, lamina interna in acciaio inox finitura satinata, strato intermedio in alluminio, esterno rame lucido. Spessore 2 mm. Manicatura in acciaio inox, rivetti inox. Adatte ad uso su tutti i fuochi (eccetto induzione).



Saucepan

Casseruola
Stielkasserolle
Casserole
Cazo recto alto

art.	Ø cm.	h.	lt.	U. Pack
15606-09	9	4,7	0,30	2
15606-10	10	6,5	0,50	2



Butter warmer

Scalda burro
Butterpfännchen
Casserole à beurre
Cacerola mantequilla

art.	Ø cm.	h.	lt.	U. Pack
15606-12	12	7	0,70	1



Saucepot

Casseruola
Fleischtopf
Brasière
Cacerola alta

art.	Ø cm.	h.	lt.	U. Pack
15607-10	10	6,5	0,50	2



Ramekin

Ramekin
Ramekin
Ramekin
Ramekin

art.	Ø cm.	h.	lt.	U. Pack
15611-12	12	6	0,60	2



Frypan

Padella
Bratpfanne
Poêle
Sartén

art.	Ø cm.	h.	lt.	U. Pack
15614-12	12	3,0	0,35	2



Omelet pan

Tegame
Servierpfanne
Poêle à paella
Paellera

art.	Ø cm.	h.	lt.	U. Pack
15615-12	12	3,0	0,35	2



Gratin

Gratin
Gratin-Pfanne
Gratin
Gratin

art.	Ø cm.	h.	lt.	U. Pack
15615-16	16	3,5	0,50	2



Oval baker

Tegame ovale
Oval-Pfanne
Casserole ovale
Sartén ovalada

art.	cm.	h.	lt.	U. Pack
15638-17	17x13	3,5	0,48	2



Rectangular baker

Tegame rettangolare
Röster
Plat à four
Sartén rectangular

art.	cm.	h.	U. Pack
15643-12	12x10	4	2



Lid

Coperchio
Deckel
Couvercle
Tapa

art.	Ø cm.	U. Pack
15661-10	10	1
15661-12	12	1



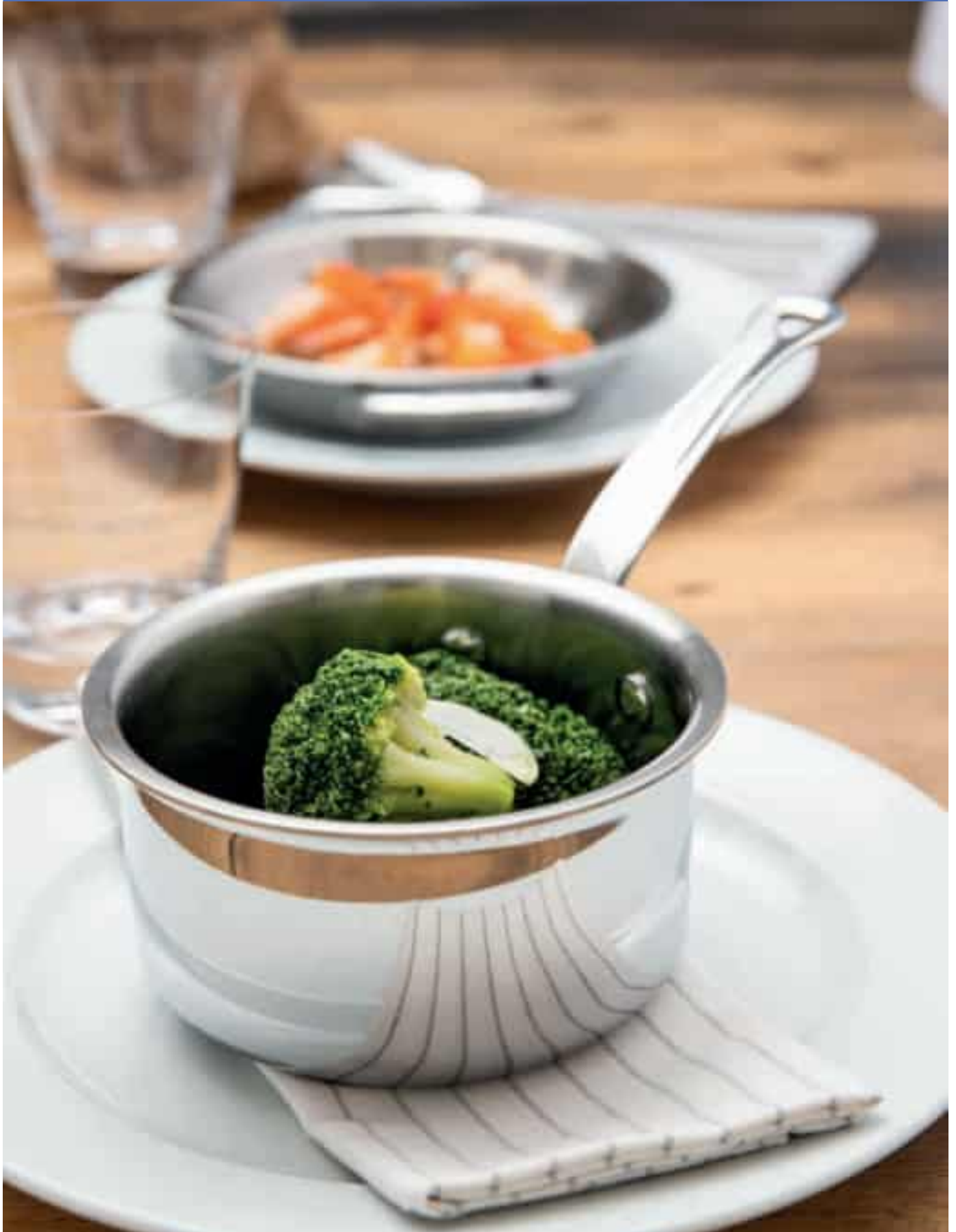

Paderno Serie 12200 3-ply, inside stainless steel satin polished, intermediate layer in aluminum, outside stainless steel mirror polished. Thickness 2 mm. Stainless steel cast handles, stainless steel rivets. Suitable for use on any heating element.

Serie Paderno 12200 3-ply, lamina interna in acciaio inox finitura satinata, strato intermedio in alluminio, esterno inox lucido. Spessore 2 mm. Manicatura in acciaio inox, rivetti inox. Adatte ad uso su tutti i fuochi.



Saucepan

Casseruola
Stielkasserolle
Casserole
Cazo recto alto

art.	Ø cm.	h.	lt.	U. Pack
12206-09	9	4,7	0,30	2
12206-10	10	6,5	0,50	2



Butter warmer

Scalda burro
Butterpfännchen
Casserole à beurre
Cacerola mantequilla

art.	Ø cm.	h.	lt.	U. Pack
12206-12	12	7	0,70	1



Saucepot

Casseruola
Fleischtopf
Brasière
Cacerola alta

art.	Ø cm.	h.	lt.	U. Pack
12207-10	10	6,5	0,50	2



Ramekin

Ramekin
Ramekin
Ramekin
Ramekin

art.	Ø cm.	h.	lt.	U. Pack
12211-12	12	6	0,60	2



Frypan

Padella
Bratpfanne
Poêle
Sartén

art.	Ø cm.	h.	lt.	U. Pack
12214-12	12	3,0	0,35	2



Omelet pan

Tegamino
Servierpfanne
Poêle à paella
Paellera

art.	Ø cm.	h.	lt.	U. Pack
12215-12	12	3,0	0,35	2



Gratin

Gratin
Gratin-Pfanne
Gratin
Gratin

art.	Ø cm.	h.	lt.	U. Pack
12215-16	16	3,5	0,50	2



Oval baker

Tegame ovale
Oval-Pfanne
Casserole ovale
Sartén ovalada

art.	cm.	h.	lt.	U. Pack
12238-17	17x13	3,5	0,48	2



Rectangular baker

Tegame rettangolare
Röster
Plat à four
Sartén rectangular

art.	cm.	h.	U. Pack
12243-12	12x10	4	2



Lid

Coperchio
Deckel
Couvercle
Tapa

art.	Ø cm.	U. Pack
12261-10	10	1
12261-12	12	1



ALUMINUM SERIES 16130
ALLUMINIO SERIE 16130



Aluminum body non-stick coated, brass handles. To add a touch of originality to any dish.

Corpo in alluminio con rivestimento antiaderente, manichatura in ottone. Per aggiungere un tocco di originalità a qualsiasi piatto.



Saucepan

Casseruola alta
Stielkasserole, hoch
Casserole haute
Cazo recto alto

art.	Ø cm.	h.	lt.
16136-10	10	6	0,45



Sauté pan

Casseruola bassa
Stielkasserole, niedrig
Plat à sauter
Cazo recto bajo

art.	Ø cm.	h.	lt.
16138-10	10	4	0,3



Frypan

Padella
Bratpfanne
Poêle à frir
Sartén

art.	Ø cm.	h.	lt.
16134-12	12	4	0,4



Saucepan

Casseruola alta
Fleischtopf
Casserole haute
Cazo recto alto

art.	Ø cm.	h.	lt.
16137-10	10	6	0,45



Casserole pot

Casseruola bassa
Bratentopf
Sautoir
Cacerola baja

art.	Ø cm.	h.	lt.
16139-10	10	4	0,3



French omelet pan

Tegamino
Servierpfanne
Poêle à paella
Paellera

art.	Ø cm.	h.	lt.
16135-12	12	4	0,4

ALUMINUM SERIES 16140
ALLUMINIO SERIE 16140



Ideal for serving from stovetop to table. Aluminum 99,5%. Thickness 3 mm. HP Dylan internal and external non-stick coating. Handle and rivets in stainless steel. Although the product can be washed in the dishwasher, we recommend hand washing to ensure beauty and performance over time.

Ideali per servire dal piano di cottura alla tavola. Alluminio 99,5%. Spessore 3 mm. Rivestimento antiaderente interno ed esterno HP Dylan. Manicatura e rivetti in acciaio inox. Anche se il prodotto può essere lavato in lavastoviglie, consigliamo di lavare a mano per conservare nel tempo bellezza e performance.



Mussel pot

Cocotte per molluschi
Muscheltopf
Casserole coquillage
Cacerola para mejillones

art.	Ø cm.	h.	lt.
16140-01	16	12	2,2



Sauce pot

Casseruola
Kasserolle
Brasière
Cacerola

art.	Ø cm.	h.	lt.
16140-02	16	7,5	1,4



Frypan

Padella
Bratpfanne
Poêle
Sartén

art.	Ø cm.	h.	lt.
16140-03	16	4	0,6



Low sauce pot

Casseruola bassa
Flache Kasserolle
Faitout bas
Cacerola baja

art.	Ø cm.	h.	lt.
16140-04	16	4,5	0,8



Wok pan

Wok
Wok-Pfanne
Poêle chinoise
Wok

art.	Ø cm.	h.	lt.
16140-05	16	6	0,9





The stoneware gives a rustic and informal tone but can also create an atmosphere with an antique flavor in the most modern environments. Similar to porcelain, it can be used in the oven and in the microwave. Suitable for storing food in the freezer. Avoid thermal shocks. Stoneware retains heat very well and distributes it evenly. Perfect for serving from the oven to the table, keeping food warm during meals. Moreover the water absorption is equal to 0%, a feature that allows to keep the flavors of the food served unchanged. Easy to clean, dishwasher safe.

Lo stoneware regala un tono rustico ed informale, ma può anche creare un'atmosfera dal sapore antico negli ambienti più moderni. Simile alla porcellana, può essere utilizzato in forno e nel microonde. Adatto alla conservazione dei cibi nel congelatore. Evitare shock termici. I pezzi in stoneware trattengono molto bene il calore e lo distribuiscono in modo uniforme. Perfetto per servire dal forno alla tavola, mantenendo il cibo caldo durante i pasti. Facile da utilizzare e pulire, inoltre l'assorbimento di acqua è pari allo 0%, caratteristica che consente di mantenere invariati i sapori dei cibi serviti. Lavabile in lavastoviglie.



Oval saucepan
Casseruola ovale
Kasserolle oval
Casserole, ovale
Cacerola oval

art.	cm.	h.
41210-03	13x8,2	3,9



Saucepan
Tegamimo
Pfännchen
Sautoir
Fuente huevo

art.	Ø cm.	h.
41210-12	13	5
41210-13	15	5
41210-14	17	5



Rectangular saucepan
Casseruola rettangolare
Kasserolle rechteckig
Casserole, rectangulaire
Cacerola rectangular

art.	cm.	h.
41210-05	13x8,2	3,9



Piepan
Tortiera
Kuchenform
Ramequin
Molde tarta

art.	Ø cm.	h.
41210-10	11	3,9



Saucepan, round
Casseruola tonda
Kasserolle rund
Casserole, ronde
Cacerola redonda

art.	Ø cm.	h.
41210-01	13	3,9



Saucepan with lid
Casseruola con coperchio
Kasserolle mit Deckel
Casserole avec couvercle
Cacerola con tapa

art.	Ø cm.	h.
41210-07	11,5	5,5
41210-08	13,0	7,5

ENAMELLED CAST IRON
GHISA SMALTATA



Manufactured in Turkey from cast iron and liquid enamel with high standards and advanced technology. Three layers of beautiful porcelain enamel fired twice for maximum beauty, durability and cooking performance. Beautiful design and individual serving size offers delightful presentation options for your entrées, appetizers or tempting desserts.

Prodotte in Turchia da ghisa e smalto liquido di elevati standard e tecnologia all'avanguardia. Tre strati di ottimo smalto porcellanato cotti due volte per il massimo in bellezza, durata e prestazioni al top. Un bel design e porzioni individuali offrono deliziose opzioni di presentazione per gustosi antipasti, contorni e dessert.



Saucepot round with lid

Casseruola tonda con coperchio
Fleischtopf, rund mit Deckel
Brasière avec couvercle
Cacerola redonda con tapa

art.	Ø cm.	lt.	col.
44201R10	10	0,35	●
44201V10	10	0,35	●
44201B10	10	0,35	●
44201O10	10	0,35	●
44201N10	10	0,35	●

Portion: – Porzioni: 1



Saucepot round with lid

Casseruola tonda con coperchio
Fleischtopf, rund mit Deckel
Brasière avec couvercle
Cacerola redonda con tapa

art.	Ø cm.	lt.	col.
44201R12	12	0,55	●
44201V12	12	0,55	●
44201B12	12	0,55	●
44201O12	12	0,55	●
44201N12	12	0,55	●

Portion: – Porzioni: 1



Oval saucepan with lid

Casseruola ovale con coperchio
Ovaler Bratentopf mit Deckel
Casserole ovale avec couvercle
Cacerola oval con tapa

art.	cm.	col.
44202R12	12x9x6	●
44202N12	12x9x6	●

Portion: – Porzioni: 1



W

Saucepot stand

Supporto casseruolina
Fleischtopf-Träger
Support pour braisière
Soporte para cacerola

art. Ø cm.
44201-01 10



W

Saucepot stand

Supporto casseruolina
Fleischtopf-Träger
Support pour braisière
Soporte para cacerola

art. Ø cm.
44201-03 10



W

Saucepot platter

Sottopentola
Fleischtopfbrett
Planche à casserole
Tabla para cacerola

art. Ø cm.
44201-10 10-12



W

Saucepot platter

Sottopentola
Fleischtopfbrett
Planche à casserole
Tabla para cacerola

art. cm.
44202-10 12x9



NEW

Mini wok

Mini wok
Mini-Wok
Mini wok
Mini wok

art. Ø cm. h. lt. Por.
44270-16 16 8 0,75 1



Pan with wooden platter

Tegame con tagliere legno
Pfanne mit Holzbrett
Poêle avec plaque bois
Paellera con tabla madera

art. Ø cm. lt. Por.
44247S16 16 0,44 1-2

Beechwood. – Faggio.



Round pan

Padella tonda
Pfanne, rund
Poêle ronde
Sartén grill redonda

art. Ø cm. Por.
44234-12 12 1
44234-16 16 1-2



Blinis pan, non-stick aluminum

Padella blini, alluminio antiaderente
Blinis-Pfännchen, Alu-Nichttafend
Poêle à blinis, alu anti-adhérente
Sartén blinis, aluminio antiaderente

art. Ø cm. h.
16719-12 12 2



Blinis pan, steel

Padella blini, ferro
Blinis-Pfännchen, Eisen
Poêle à blinis, acier
Sartén blinis, hierro

art. Ø cm. h.
11715-12 12 2



SERIES 1100

STAINLESS STEEL COOKWARE
PENTOLAME INOX



Outside and inside satin polished. Top edges mirror polished. Hollow tubular stay cool handles in stainless steel, ergonomically shaped. Extra thick edges. Double thick bottom. Sandwich thermoradiant bottom (stainless steel-aluminum-stainless steel). Concave bottom when cold and flat when hot (100% heat exploiting). Perfect for use on any type of stove, whether gas, electric, glass ceramic cooking surface or induction stove. All items have an induction suited sandwich bottom.

Finitura esterna ed interna satinata, bordo lucido. Manicatura tubolare in acciaio inox, anatomica, resistente al calore. Bordo rinforzato. Doppio spessore del fondo. Fondo termodiffusore sandwich (inox-alluminio-inox). Concavo a freddo e piano a caldo (sfruttamento del calore al 100%). Ideali per ogni tipo di cottura, gas, elettrica, vetroceramica e induzione. Tutti gli articoli sono dotati di speciale fondo termodiffusore adatto anche per piastre ad induzione.



Stock pot

Pentola
Hoher Suppentopf
Marmite traiteur
Olla recta

art.	Ø cm.	h.	lt.
11101-16	16	16	3,2
11101-20	20	20	6,2
11101-24	24	24	10,0
11101-28	28	28	16,5
11101-32	32	32	24,0
11101-36	36	36	36,0
11101-40	40	40	50,0
11101-45	45	45	70,0
11101-50	50	50	100,0



Low stock pot

Pentola bassa
Gemüsetopf
Faitout
Olla recta baja

art.	Ø cm.	h.	lt.
11105-20	20	17	5,0
11105-24	24	21	8,5
11105-28	28	23	14,5
11105-36	36	28	29,0



Saucepot

Casseruola alta
Fleischtopf
Brasière
Cacerola alta

art.	Ø cm.	h.	lt.
11107-16	16	11,0	2,1
11107-20	20	13,0	4,0
11107-24	24	15,0	6,5
11107-28	28	17,5	10,8
11107-32	32	19,5	15,7
11107-36	36	21,5	22,0
11107-40	40	24,5	30,8
11107-45	45	27,5	44,0
11107-50	50	32,0	63,0



Casserole pot

Casseruola bassa
Bratentopf
Sautoir
Cacerola baja

art.	Ø cm.	h.	lt.
11109-16	16	7,5	1,3
11109-20	20	8,0	2,5
11109-24	24	9,5	4,3
11109-28	28	11,0	6,7
11109-32	32	12,5	10,0
11109-36	36	14,0	14,2
11109-40	40	15,5	19,5
11109-45	45	17,0	27,0
11109-50	50	19,0	37,0



Colander for stock pot

Colapasta per pentola
Seiher für Suppentopf
Passoire pour marmite
Colador para olla recta

art.	Ø cm.	h.
11123-20	20	22,0
11123-24	24	26,5
11123-28	28	29,5

Suitable for both item 11105 and 11101.
Per art. 11105 e art. 11101.



Stock pot with tap

Pentola con rubinetto
Hochtopf mit Hahn
Marmite avec robinet
Olla con grifo

art.	Ø cm.	h.	lt.
11102-28	28	28	16,5
11102-32	32	32	24,0
11102-36	36	36	36,0
11102-40	40	40	50,0
11102-45	45	45	70,0
11102-50	50	50	100,0



Steamer pot, perforated bottom

Inserto a vapore, fondo forato
Dampf-Siebeinsatz
Casserole à vapeur, perforée
Cacerola base perforada

art.	Ø cm.	h.
11119-20	20	12,5
11119-28	28	17,0



Saucepan

Casseruola alta
Stielkasserolle, hoch
Casserole haute
Cazo recto alto

art.	Ø cm.	h.	lt.
11106-14	14	8,0	1,2
11106-16	16	11,0	2,1
11106-20	20	13,0	4,0
11106-24	24	15,0	6,5
11106-28*	28	17,5	10,8
11106-32*	32	19,5	15,7
11106-36*	36	21,5	22,0

*With loop handle. – Con contromaniglia.



Sauté pan

Casseruola bassa
Stielkasserolle, niedrig
Plat à sauter
Cazo recto bajo

art.	Ø cm.	h.	lt.
11108-16	16	6,5	1,3
11108-20	20	8,0	2,5
11108-24	24	9,5	4,3
11108-28*	28	11,0	6,7
11108-32*	32	12,5	10,0
11108-36*	36	14,0	14,2

*With loop handle. – Con contromaniglia.



Sauté pan

Casseruola conica
Sauteuse
Sauteuse
Cazo cónico

art.	Ø cm.	h.	lt.
11112-16	16	6,0	1,0
11112-18	18	6,0	1,2
11112-20	20	6,5	1,6
11112-24	24	7,5	2,7



Curved sauté pan

Casseruola "bombé"
Sauteuse mit Schüttrand
Sauteuse bombé
Cazo bombeado

art.	Ø cm.	h.	lt.
11113-18	18	7,0	1,7
11113-20	20	7,5	2,2
11113-24	24	8,5	3,3
11113-26	26	9,0	4,2



Frypan

Padella
Bratpfanne
Poêle à frire
Sartén

art.	Ø cm.	h.
11114-20	20	5,0
11114-24	24	5,0
11114-28	28	5,5
11114-32	32	6,0
11114-36*	36	6,0
11114-40*	40	6,0
11114-45*	45	6,5

*With loop handle. – Con contromaniglia.



Frypan, non stick coating

Padella, antiaderente
Bratpfanne mit Antihafbeschichtung
Poêle avec revêtement anti-adhésif
Sartén antiaderente

art.	Ø cm.	h.
11117-20	20	5,0
11117-24	24	5,0
11117-28	28	5,5
11117-32	32	6,0
11117-36	36	6,0
11117-40	40	6,0



French omelet pan

Tegame
Servierpfanne
Poêle à paella
Paellera

art.	Ø cm.	h.
11115-20	20	5,0
11115-24	24	5,0
11115-28	28	5,5
11115-32	32	6,0
11115-36	36	6,0
11115-40	40	6,0
11115-45	45	6,5
11115-50	50	8,0



Cover, reinforced edge

Coperchio, bordo rinforzato
Deckel mit Randverstärkung
Couvercle, bord renforcé
Tapa, borde reforzado

art.	Ø cm.
11161-12	12
11161-14	14
11161-16	16
11161-18	18
11161-20	20
11161-22	22
11161-24	24
11161-28	28
11161-32	32
11161-36	36
11161-40	40
11161-45	45
11161-50	50
11161-60	60



SERIES 2100

STAINLESS STEEL COOKWARE
PENTOLAME INOX



The serie 2100 has the same characteristics of the serie 1100. It varies only for the shape of the handles of 2 handles items. Perfect for use on any type of stove, whether gas, electric, glass ceramic cooking surface or induction stove. All items have an induction suited sandwich bottom.

La serie 2100 ha le stesse caratteristiche della serie 1100. Differisce solo per una diversa manicatura sugli articoli a 2 maniglie. Ideali per ogni tipo di cottura, gas, elettrica, vetroceramica e induzione. Tutti gli articoli sono dotati di speciale fondo termodiffusore adatto anche per piastre ad induzione.



Stock pot

Pentola
Hoher Suppentopf
Marmite traiteur
Olla recta

art.	Ø cm.	h.	lt.
12101-16	16	16	3,2
12101-20	20	20	6,2
12101-24	24	24	10,0
12101-28	28	28	16,5
12101-32	32	32	24,0
12101-36	36	36	36,0
12101-40	40	40	50,0
12101-45	45	45	70,0
12101-50	50	50	100,0



Saucepot

Casseruola alta
Fleischtopf
Brasière
Cacerola alta

art.	Ø cm.	h.	lt.
12107-16	16	11,0	2,1
12107-20	20	13,0	4,0
12107-24	24	15,0	6,5
12107-28	28	17,5	10,8
12107-32	32	19,5	15,7
12107-36	36	21,5	22,0
12107-40	40	24,5	30,8
12107-45	45	27,5	44,0
12107-50	50	32,0	63,0



Casserole pot

Casseruola bassa
Bratentopf
Sautoir
Cacerola baja

art.	Ø cm.	h.	lt.
12109-16	16	7,5	1,3
12109-20	20	8,0	2,5
12109-24	24	9,5	4,3
12109-28	28	11,0	6,7
12109-32	32	12,5	10,0
12109-36	36	14,0	14,2
12109-40	40	15,5	19,5
12109-45	45	17,0	27,0
12109-50	50	19,0	37,0



SERIES 1000

STAINLESS STEEL COOKWARE
PENTOLAME INOX



Outside and inside satin polished. Non-drip edge. Hollow tubular stay cool handles in stainless steel, ergonomically shaped. Uniform thickness in sides and bottoms. Sandwich thermoradiant bottom (stainless steel-aluminum-stainless steel). Concave bottom when cold and flat when hot (100% heat exploiting). Perfect for use on any type of stove, whether gas, electric, glass ceramic cooking surface or induction stove. All items have an induction suited sandwich bottom.

Finitura esterna ed interna satinata. Bordo a versare. Manicatura tubolare in acciaio inox, anatomica, resistente al calore. Parete e fondo a spessore uniforme. Fondo termodiffusore sandwich (inox-alluminio-inox). Concavo a freddo e piano a caldo (sfruttamento del calore al 100%). Ideali per ogni tipo di cottura, gas, elettrica, vetroceramica e induzione. Tutti gli articoli sono dotati di speciale fondo termodiffusore adatto anche per piastre ad induzione.



Stock pot

Pentola
Hoher Suppentopf
Marmite traiteur
Olla recta

art.	Ø cm.	h.	lt.
11001-16	16	16,0	3,2
11001-18	18	16,0	4,0
11001-20	20	18,0	5,5
11001-22	22	22,0	8,3
11001-24	24	24,0	10,5
11001-28	28	28,0	17,0
11001-32	32	27,5	20,4
11001-36	36	36,0	36,5
11001-40	40	40,0	50,0
11001-45	45	40,0	63,5
11001-50	50	50,0	98,0
11001-60	60	55,0	150,0



Saucepot

Casseruola alta
Fleischtopf
Brasière
Cacerola alta

art.	Ø cm.	h.	lt.
11007-16	16	9,5	1,9
11007-18	18	10,8	2,7
11007-20	20	12,0	3,8
11007-22	22	13,0	5,0
11007-24	24	14,5	6,5
11007-28	28	16,0	9,8
11007-32	32	19,5	15,4
11007-36	36	21,5	20,5
11007-40	40	24,0	30,1
11007-45	45	27,0	42,9
11007-50	50	30,0	58,0
11007-60	60	35,0	99,0



Casserole pot

Casseruola bassa
Bratentopf
Sautoir
Cacerola baja

art.	Ø cm.	h.	lt.
11009-16	16	6,5	1,3
11009-18	18	7,0	1,8
11009-20	20	7,5	2,5
11009-24	24	8,0	3,7
11009-28	28	9,5	5,8
11009-32	32	11,0	9,2
11009-36	36	13,0	13,0
11009-40	40	14,5	18,0
11009-45	45	15,5	24,6
11009-50	50	19,0	37,0
11009-60	60	25,0	70,7



Saucepan

Casseruola mezza alta
Bratentopf, mittelhoch
Casserole
Cacerola francés

art.	Ø cm.	h.	lt.
11010-16	16	8	1,6
11010-18	18	9	2,3
11010-20	20	10	3,1
11010-24	24	12	5,4



Sauté pan

Casseruola conica
Sauteuse
Sauteuse
Cazo cónico

art.	Ø cm.	h.	lt.
11012-16	16	6,0	1,0
11012-18	18	6,0	1,2
11012-20	20	6,5	1,6
11012-24	24	7,5	2,7



Curved sauté pan

Casseruola bombé
Sauteuse mit Schüttrand
Sauteuse bombé
Cazo bombeado

art.	Ø cm.	h.	lt.
11013-18	18	7,0	1,7
11013-20	20	7,5	2,2
11013-24	24	8,5	3,3
11013-26	26	9,0	4,2





Saucepan

Casseruola alta
Stielkasserolle, hoch
Casserole haute
Cazo recto alto

art.	Ø cm.	h.	lt.
11006-12	12	7,0	0,8
11006-14	14	8,0	1,2
11006-16	16	9,5	1,9
11006-18	18	10,8	2,7
11006-20	20	12,0	3,8
11006-22	22	13,0	5,0
11006-24	24	14,5	6,5
11006-28*	28	16,0	9,8
11006-32*	32	19,5	15,4
11006-36*	36	21,5	20,5

*With loop handle. – Con contromaniglia.



Saucepan

Casseruola mezza alta
Stielkasserolle, mittelhoch
Casserole
Cazo recto francés

art.	Ø cm.	h.	lt.
11011-16	16	8	1,6
11011-18	18	9	2,3
11011-20	20	10	3,1
11011-24	24	12	5,4



Sauté pan

Casseruola bassa
Stielkasserolle, niedrig
Plat à sauter
Cazo recto bajo

art.	Ø cm.	h.	lt.
11008-16	16	6,5	1,3
11008-18	18	7,0	1,8
11008-20	20	7,5	2,5
11008-24	24	8,0	3,7
11008-28*	28	9,5	5,8
11008-32*	32	11,0	9,2
11008-36*	36	13,0	13,0

*With loop handle. – Con contromaniglia.



Frypan

Padella
Bratpfanne
Poêle à frire
Sartén

art.	Ø cm.	h.
11014-20	20	5,0
11014-24	24	5,0
11014-28	28	5,5
11014-32	32	6,0
11014-36*	36	6,0
11014-40*	40	6,0
11114-45*	45	6,5

*With loop handle. – Con contromaniglia.



Frypan, non stick

Padella, antiaderente
Bratpfanne, nichttaftend
Poêle, anti-adhérente
Sartén antiadherente

art.	Ø cm.	h.
11117-20	20	5,0
11117-24	24	5,0
11117-28	28	5,5
11117-32	32	6,0
11117-36	36	6,0
11117-40	40	6,0



French omelet pan

Tegame
Servierpfanne
Poêle à paella
Paellera

art.	Ø cm.	h.
11115-20	20	5,0
11115-24	24	5,0
11115-28	28	5,5
11115-32	32	6,0
11115-36	36	6,0
11115-40	40	6,0
11115-45	45	6,5
11115-50	50	8,0



Cover

Coperchio
Deckel
Couvercle
Tapa

art.	Ø cm.
11061-12	12
11061-16	16
11061-18	18
11061-20	20
11061-22	22
11061-24	24
11061-28	28
11061-32	32
11061-36	36
11061-40	40
11061-45	45
11061-50	50
11161-60	60





SERIES 2000

STAINLESS STEEL COOKWARE
PENTOLAME INOX



The serie 2000 has the same characteristics of the serie 1000. It varies only for the shape of the handles of 2 handles items. Perfect for use on any type of stove, whether gas, electric, glass ceramic cooking surface or induction stove. All items have an induction suited sandwich bottom.

La serie 2000 ha le stesse caratteristiche della serie 1000. Differisce solo per una diversa manicatura sugli articoli a 2 maniglie. Ideali per ogni tipo di cottura, gas, elettrica, vetroceramica e induzione. Tutti gli articoli sono dotati di speciale fondo termodiffusore adatto anche per piastre ad induzione.



Stock pot

Pentola
Hoher Suppentopf
Marmite traiteur
Olla recta

art.	Ø cm.	h.	lt.
12001-16	16	16,0	3,2
12001-18	18	16,0	4,0
12001-20	20	18,0	5,5
12001-22	22	22,0	8,3
12001-24	24	24,0	10,5
12001-28	28	28,0	17,0
12001-32	32	27,5	20,4
12001-36	36	36,0	36,5
12001-40	40	40,0	50,0
12001-45	45	40,0	63,5
12001-50	50	50,0	98,0
12001-60	60	55,0	150,0



Saucepot

Casseruola alta
Fleischtopf
Brasière
Cacerola alta

art.	Ø cm.	h.	lt.
12007-16	16	9,5	1,9
12007-18	18	10,8	2,7
12007-20	20	12,0	3,8
12007-22	22	13,0	5,0
12007-24	24	14,5	6,5
12007-28	28	16,0	9,8
12007-32	32	19,5	15,4
12007-36	36	21,5	20,5
12007-40	40	24,0	30,1
12007-45	45	27,0	42,9
12007-50	50	30,0	58,0
12007-60	60	35,0	99,0



Casserole pot

Casseruola bassa
Bratentopf
Sautoir
Cacerola baja

art.	Ø cm.	h.	lt.
12009-16	16	6,5	1,3
12009-18	18	7,0	1,8
12009-20	20	7,5	2,5
12009-24	24	8,0	3,7
12009-28	28	9,5	5,8
12009-32	32	11,0	9,2
12009-36	36	13,0	13,0
12009-40	40	14,5	18,0
12009-45	45	15,5	24,6
12009-50	50	19,0	37,0
12009-60	60	25,0	70,7



Sauté pan

Casseruola conica
Sauteuse
Sauteuse
Cazo cónico

art.	Ø cm.	h.	lt.
11012-16	16	6,0	1,0
11012-18	18	6,0	1,2
11012-20	20	6,5	1,6
11012-24	24	7,5	2,7



Curved sauté pan

Casseruola bombé
Sauteuse mit Schüttrand
Sauteuse bombé
Cazo bombeado

art.	Ø cm.	h.	lt.
11013-18	18	7,0	1,7
11013-20	20	7,5	2,2
11013-24	24	8,5	3,3
11013-26	26	9,0	4,2



Saucepan

Casseruola mezza alta
Stielkasserolle, mittelhoch
Casserole
Cazo recto francés

art.	Ø cm.	h.	lt.
11011-16	16	8,0	1,6
11011-18	18	9,0	2,3
11011-20	20	10,0	3,1
11011-24	24	12,0	5,4





Asparagus-pot with lid

Pentola cuociasparagi con coperchio
Spargeltopf mit Deckel
Cuit-asperges avec couvercle
Olla espárragos con tapa

art.	Ø cm.	h.	lt.
12037-16	16	24,0	4,8



Saucepan

Casseruola alta
Stielkasserolle, hoch
Casserole haute
Cazo recto alto

art.	Ø cm.	h.	lt.
11006-12	12	7,0	0,8
11006-14	14	8,0	1,2
11006-16	16	9,5	1,9
11006-18	18	10,8	2,7
11006-20	20	12,0	3,8
11006-22	22	13,0	5,0
11006-24	24	14,5	6,5
11006-28*	28	16,0	9,8
11006-32*	32	19,5	15,4
11006-36*	36	21,5	20,5

*With loop handle. – Con contromaniglia.



Sauté pan

Casseruola bassa
Stielkasserolle, niedrig
Plat à sauter
Cazo recto bajo

art.	Ø cm.	h.	lt.
11008-16	16	6,5	1,3
11008-18	18	7,0	1,8
11008-20	20	7,5	2,5
11008-24	24	8,0	3,7
11008-28*	28	9,5	5,8
11008-32*	32	11,0	9,2
11008-36*	36	13,0	13,0

*With loop handle. – Con contromaniglia.



Frypan

Padella
Bratpfanne
Poêle à frire
Sartén

art.	Ø cm.	h.
11014-20	20	5,0
11014-24	24	5,0
11014-28	28	5,5
11014-32	32	6,0
11014-36*	36	6,0
11014-40*	40	6,0
11114-45*	45	6,5

*With loop handle. – Con contromaniglia.



Frypan, non stick

Padella, antiaderente
Bratpfanne, nichtaftend
Poêle, anti-adhérente
Sartén antiaderente

art.	Ø cm.	h.
11117-20	20	5,0
11117-24	24	5,0
11117-28	28	5,5
11117-32	32	6,0
11117-36	36	6,0
11117-40	40	6,0



French omelet pan

Tegame
Servierpfanne
Poêle à paella
Paellera

art.	Ø cm.	h.
11115-20	20	5,0
11115-24	24	5,0
11115-28	28	5,5
11115-32	32	6,0
11115-36	36	6,0
11115-40	40	6,0
11115-45	45	6,5
11115-50	50	8,0



Cover

Coperchio
Deckel
Couvercle
Tapa

art.	Ø cm.
11061-16	16
11061-18	18
11061-20	20
11061-22	22
11061-24	24
11061-28	28
11061-32	32
11061-36	36
11061-40	40
11061-45	45
11061-50	50
11161-60	60



FOR **GLUTEN-FREE** COOKING



AL SERVIZIO DELLA CUCINA SENZA GLUTINE

FOR PRODUCT # LIST SEE PAGES AFTER SECTION "ELECTRIC APPLIANCES"
PER L'ELENCO PRODOTTI VEDI PAGINE DOPO LA SEZIONE "APPARECCHI ELETTRICI"



Consistently with the functional approach, which has always marked the brand, Paderno offers a complete product line and professional tools, easily recognizable in the kitchen, which can reduce possible mistakes during their use to protect people affected by celiac disease. Developed and realized in 2013 in collaboration with Associazione Italiana Celiachia Lombardia ONLUS (Italian Society for the Celiac Disease – Lombardy Section), this project makes Sambonet Paderno Industrie S.p.A. the first company in its market that offers to the HoReCa channel a complete line of items intended for gluten-free cooking.

Some distinguished special features, such as golden PVD handles for pans and pots and a special customised logo for utensils, will allow professionals to easily identify all these items in the kitchen.

This product line aims at:

- Reducing the risk of accidental food cross-contamination;
- Making it easier for professionals to work and provide services to clients with food intolerances;
- Raising awareness on the gluten-free diet issue in the industry so as to respond to the new needs of consumers.

Coerentemente all'ottica di servizio che contraddistingue da sempre il marchio, Paderno propone una linea completa di articoli e strumenti professionali facilmente identificabili in cucina, in grado di abbattere eventuali errori durante il loro utilizzo a salvaguardia del cliente celiaco e di tutti gli intolleranti. Sviluppato e concretizzato nel 2013 in collaborazione con l'Associazione Italiana Celiachia Lombardia ONLUS, questo progetto colloca Sambonet Paderno Industrie come prima azienda del settore a offrire al canale Ho.Re.Ca una linea completa di articoli da destinare alla preparazione di pietanze senza glutine.

Attraverso alcuni elementi distintivi e differenzianti, come manici in PVD oro per pentole e padelle e personalizzazione con un logo specifico per utensili, tutti gli strumenti saranno facilmente identificabili in cucina.

Questa gamma contribuisce a:

- Diminuire il rischio di accidentali contaminazioni crociate degli alimenti;
- Facilitare il professionista nell'operare e nell'offrire un servizio a favore del cliente con intolleranze alimentari;
- Sensibilizzare il settore sul tema "gluten free" di fronte alle nuove esigenze dei consumatori.

SERIES 2500 3-PLY

STAINLESS STEEL COOKWARE
PENTOLAME INOX

**INDUCTION
READY!**



Paderno serie 2500 3-ply is especially designed for professional kitchens, features super heat-conductive multi-layer construction that distributes heat from bottom to rim quickly and evenly. Outside and inside satin polished. Non-drip edge. Stainless steel handles, ergonomically shaped. Uniform thickness in sides and bottoms. Energy saving on all types of cookers. Suitable for use on all cooking hobs including induction.

La serie Paderno 2500 3-ply concepita per l'utilizzo nelle cucine professionali è costruita in materiale multistrato che assicura una distribuzione rapida ed uniforme del calore su tutta la superficie dell'utensile. Finitura esterna ed interna satinata. Bordo a versare. Manicatura anatomica in acciaio inox. Parete e fondo a spessore uniforme. Risparmio di energia. Adatta per l'uso su tutti i piani cottura compresa l'induzione.



Saucepot

Casseruola alta
Fleischtopf
Brasière
Cacerola alta

art.	Ø cm.	h. cm.	lt.
12507-24	24	11,5	5,0
12507-28	28	14,0	8,5



Casserole pot

Casseruola bassa
Bratentopf
Sautoir
Cacerola baja

art.	Ø cm.	h. cm.	lt.
12509-20	20	9,5	2,8
12509-24	24	10,5	4,7
12509-28	28	11,0	6,5



Saucepan

Casseruola mezza alta
Stielkasserolle, mittelhoch
Casserole
Cazo recto francés

art.	Ø cm.	h. cm.	lt.
12511-16	16	7,5	1,5
12511-18	18	8,0	2,0
12511-20	20	8,8	2,5
12511-24	24	10,5	4,6



Sauté pan

Casseruola bassa
Stielkasserolle, niedrig
Plat à sauter
Cazo recto bajo

art.	Ø cm.	h. cm.	lt.
12508-24	24	5,0	2,0



Wok with grid and cover

Wok c/griglia e coperchio
Wok mit Rost und Deckel
Wok avec grille et couvercle
Wok con rejilla y tapa

art.	Ø cm.	h. cm.
12529-32	32	8



Curved sauté pan

Casseruola bombé
Sauteuse mit Schüttrand
Sauteuse bombé
Cazo bombeado

art.	Ø cm.	h. cm.	lt.
12513-16	16	6,0	1,2
12513-18	18	6,5	1,6
12513-20	20	7,0	2,0
12513-24	24	8,5	3,8



Frypan

Padella
Bratpfanne
Poêle à frir
Sartén

art.	Ø cm.	h. cm.
12514-24	24	5,5
12514-26	26	5,5
12514-28	28	5,5
12514-32	32	4,0
12514-36	36	4,0



Frypan, non stick coating

Padella, antiaderente
Bratpfanne mit Antihafbeschichtung
Poêle avec revêtement anti-adhésif
Sartén antiadherente

art.	Ø cm.	h. cm.
12517-24	24	5,5
12517-26	26	5,5
12517-28	28	5,5
12517-32	32	5,5
12517-36	36	5,5



Lid

Coperchio
Deckel
Couvercle
Tapa

art.	Ø cm.
12561-16	16
12561-18	18
12561-20	20
12561-24	24
12561-26	26
12561-28	28

SERIES 12300 3-PLY

STAINLESS STEEL COOKWARE
PENTOLAME INOX



Paderno serie 2300 3-ply is especially designed for front cooking and live cooking stations. Features super heat-conductive multi-layer construction that distributes heat from bottom to rim quickly and evenly. An attractive, multifunctional and colored line available in white, yellow, green, blue and orange. External finish with special heat-resistant paint (Whitford technology). Ideal for all types of cooking including induction. The lid equipped with a steam release device can be hooked to the side of the pan.

La serie Paderno 2300 3-ply è concepita per il "front cooking" e per le "live cooking stations". Costruita in materiale multistrato, assicura una distribuzione rapida ed uniforme del calore su tutta la superficie dell'utensile. Una linea attrattiva, multifunzionale e colorata disponibile nelle varianti bianco, giallo, verde, blu e arancio. Finitura esterna con speciale vernice (tecnologia Whitford) resistente al calore. Ideale per ogni tipo di cottura inclusa l'induzione. Il coperchio dotato di dispositivo di rilascio del vapore, può essere agganciato a lato della casseruola.



Stew pan with lid

Casseruola con coperchio
 Brattpf mit Deckel
 Sautoir avec couvercle
 Sartén con tapa

art.	Ø cm.	h. cm.	lt.
12303W16	16	8	1,6
12303W20	20	10	3,1
12303W24	24	12	5,4



Stew pan with lid

Casseruola con coperchio
 Brattpf mit Deckel
 Sautoir avec couvercle
 Sartén con tapa

art.	Ø cm.	h. cm.	lt.
12303Y16	16	8	1,6
12303Y20	20	10	3,1
12303Y24	24	12	5,4



Stew pan with lid

Casseruola con coperchio
 Brattpf mit Deckel
 Sautoir avec couvercle
 Sartén con tapa

art.	Ø cm.	h. cm.	lt.
12303G16	16	8	1,6
12303G20	20	10	3,1
12303G24	24	12	5,4



Stew pan with lid

Casseruola con coperchio
 Brattpf mit Deckel
 Sautoir avec couvercle
 Sartén con tapa

art.	Ø cm.	h. cm.	lt.
12303B16	16	8	1,6
12303B20	20	10	3,1
12303B24	24	12	5,4



Stew pan with lid

Casseruola con coperchio
 Brattpf mit Deckel
 Sautoir avec couvercle
 Sartén con tapa

art.	Ø cm.	h. cm.	lt.
12303O16	16	8	1,6
12303O20	20	10	3,1
12303O24	24	12	5,4



Roasting pan with lid

Casseruola carrè con coperchio
 Bräter mit Deckel
 Rôtissoire avec couvercle
 Asadera con tapa

art.	cm.	h. cm.	lt.
12304W26	27x27	7	4



Roasting pan with lid

Casseruola carrè con coperchio
 Bräter mit Deckel
 Rôtissoire avec couvercle
 Asadera con tapa

art.	cm.	h. cm.	lt.
12304Y26	27x27	7	4



Roasting pan with lid

Casseruola carrè con coperchio
 Bräter mit Deckel
 Rôtissoire avec couvercle
 Asadera con tapa

art.	cm.	h. cm.	lt.
12304G26	27x27	7	4



Roasting pan with lid

Casseruola carrè con coperchio
 Bräter mit Deckel
 Rôtissoire avec couvercle
 Asadera con tapa

art.	cm.	h. cm.	lt.
12304B26	27x27	7	4



Roasting pan with lid

Casseruola carrè con coperchio
 Bräter mit Deckel
 Rôtissoire avec couvercle
 Asadera con tapa

art.	cm.	h. cm.	lt.
12304O26	27x27	7	4





Induction station
Stazione induzione
Induktionsstation
Station d'induction
Estación inducción

art.	Ø cm.	cm.	h. cm.	scala	range
49999-04	24	35,4x32,5	19	220-240	900

Induction plate with temperature regulator 60>140°C. Black metal support, walnut wood insert and stainless steel frame. – Piastra a induzione con regolatore di temperatura 60>140°C. Supporto in metallo nero, inserto in legno di noce e cornice inox.

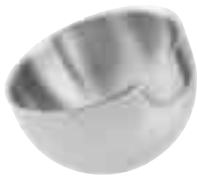

Bowl double wall
Ciotola doppia parete
Schüssel, doppelwandig
Bol à double paroi
Tazón doble pared

art.	Ø cm.	h. cm.
12300-18	18	14,0
12300-24	24	18,2



Bowl double wall
Ciotola doppia parete
Schüssel, doppelwandig
Bol à double paroi
Tazón doble pared

art.	Ø cm.	h. cm.
12300W18	18	14,0
12300W24	24	18,2



Bowl double wall
Ciotola doppia parete
Schüssel, doppelwandig
Bol à double paroi
Tazón doble pared

art.	Ø cm.	h. cm.
12300Y18	18	14,0
12300Y24	24	18,2



Bowl double wall
Ciotola doppia parete
Schüssel, doppelwandig
Bol à double paroi
Tazón doble pared

art.	Ø cm.	h. cm.
12300G18	18	14,0
12300G24	24	18,2

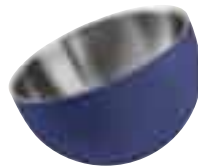

Bowl double wall
Ciotola doppia parete
Schüssel, doppelwandig
Bol à double paroi
Tazón doble pared

art.	Ø cm.	h. cm.
12300B18	18	14,0
12300B24	24	18,2



Bowl double wall
Ciotola doppia parete
Schüssel, doppelwandig
Bol à double paroi
Tazón doble pared

art.	Ø cm.	h. cm.
12300O18	18	14,0
12300O24	24	18,2





SERIES 6100

ALUMINUM COOKWARE
PENTOLAME ALLUMINIO



Made in heavy duty aluminum.
Hollow tubular handles in stainless steel 18/10, stay cool.
Rounded corners provide easy cleanup.
Thickness from mm 2 to mm 5,5.

Esecuzione in alluminio pesante.
Manicatura tubolare in acciaio inossidabile 18/10, resistente al calore.
Ampio raggio di raccordo fondo-parete, igienico e facile da pulire.
Spessore da mm 2 a mm 5,5.



Stock pot

Pentola
Hoher Suppentopf
Marmite traiteur
Olla recta

art.	Ø cm.	h. cm.	lt.
16101-16	16	16,0	3,2
16101-20	20	20,0	6,2
16101-24	24	24,0	10,0
16101-28	28	28,0	16,5
16101-32	32	29,5	22,0
16101-36	36	36,0	36,0
16101-40	40	40,0	50,0
16101-45	45	45,0	70,0
16101-50	50	50,0	100,0



Saucepot

Casseruola alta
Fleischtopf
Brasière
Cacerola alta

art.	Ø cm.	h. cm.	lt.
16107-16	16	11,0	2,1
16107-20	20	13,0	4,0
16107-28	28	17,5	10,8
16107-32	32	19,5	15,7
16107-36	36	21,0	21,5
16107-40	40	24,0	30,0
16107-45	45	27,0	43,0
16107-50	50	30,0	59,0



Casserole pot

Casseruola bassa
Bratentopf
Sautoir
Cacerola baja

art.	Ø cm.	h. cm.	lt.
16109-24	24	9,5	4,3
16109-28	28	11,0	6,7
16109-32	32	12,5	10,0
16109-36	36	14,0	14,0
16109-40	40	16,0	20,0
16109-45	45	18,0	28,5
16109-50	50	19,0	37,0



Saucepot

Casseruola
Gemüsetopf
Brasière
Cacerola

art.	Ø cm.	h. cm.	lt.
16929-36	36	17	17,0
16929-40	40	18	22,5



Oval saucepan with cover

Casseruola ovale con coperchio
Ovale Kasserolle mit Deckel
Casserole ovale avec couvercle
Cacerola oval con tapa

art.	Ø cm.	h. cm.	lt.
16938-36	36	14,5	10
16938-40	40	16,0	14
16938-45	45	17,0	19



Saucepan

Casseruola alta
Stielkasserolle, hoch
Casserole haute
Cazo recto alto

art.	Ø cm.	h. cm.	lt.
16106-16	16	11,0	2,1
16106-20	20	13,0	4,0
16106-24	24	15,0	6,5
16106-28	28	17,5	10,8



Casserole pot

Casseruola bassa
Stielkasserolle, niedrig
Sautoir
Cacerola baja

art.	Ø cm.	h. cm.	lt.
16108-24	24	9,5	4,3
16108-28	28	11,0	6,7



Frypan

Padella
Bratpfanne
Poêle à frirer
Sartén

art.	Ø cm.	h. cm.
16114-20	20	4,0
16114-24	24	5,0
16114-28	28	5,0
16114-32	32	5,3
16114-36	36	6,0
16114-40	40	7,0



French omelet pan

Tegame
Servierpfanne
Poêle à paella
Paellera

art.	Ø cm.	h. cm.
16115-36	36	7,0
16115-40	40	7,5
16115-45	45	7,5



Lid
Coperchio
Deckel
Couvercle
Tapa

art.	Ø cm.
16961-16	16
16961-20	20
16961-24	24
16961-28	28
16961-32	32
16961-36	36
16961-40	40
16961-45	45
16961-50	50
16961-60	60



Casserole pot, non stick
Casseruola alta, antiaderente
Fleischtopf, nichttaftend
Brasière, anti-adhérente
Cacerola alta, antiadherente

art.	Ø cm.	h. cm.	lt.
16127-16	16	11,0	2,1
16127-20	20	13,0	4,0
16127-32	32	19,5	15,7
16127-36	36	21,0	21,5
16127-40	40	24,0	30,0



Casserole pot, non stick
Casseruola bassa, antiaderente
Bratentopf, nichttaftend
Sautoir, anti-adhérente
Cacerola baja, antiadherente

art.	Ø cm.	h. cm.	lt.
16120-24	24	9,5	4,3
16120-28	28	11,0	6,7
16120-32	32	12,5	10,0
16120-36	36	14,0	14,0
16120-40	40	16,0	20,0





French omelet pan, non stick
Tegame, antiaderente
Servierpfanne, nichttaftend
Poêle à paella, anti-adhérente
Paellera antiaderente

art.	Ø cm.	h. cm.
16116-28	28	6,5
16116-32	32	6,5
16116-36	36	7,0
16116-40	40	7,5



Frypan, non stick
Padella, antiaderente
Bratpfanne, nichttaftend
Poêle, anti-adhérente
Sartén antiaderente

art.	Ø cm.	h. cm.
41720-18	18	3,8
41720-20	20	3,8
41720-24	24	4,5
41720-28	28	5,4
41720-30	30	5,4
41720-32	32	5,6



Frypan, non stick
Padella, antiaderente
Bratpfanne, nichttaftend
Poêle, anti-adhérente
Sartén antiaderente

art.	Ø cm.	h. cm.
16117-20	20	4,0
16117-24	24	5,0
16117-28	28	5,0
16117-32	32	5,3
16117-36	36	6,0
16117-40	40	7,0



Frypan, non stick
Padella, antiaderente
Bratpfanne, nichttaftend
Poêle, anti-adhérente
Sartén antiaderente

art.	Ø cm.	h. cm.	
11617-20	20	4,7	-
11617-24	24	4,7	-
11617-28	28	5,5	-
11617-32	32	5,5	-
11617-36	36	5,7	NEW
11617-40	40	6,0	NEW

An innovative surface characterized by very hard reliefs that protect the coating with 3 times higher scratch resistance. The rough shape increases the heat exchange surface and thermal conductivity, allowing uniform cooking and energy saving. Perfect non-stick: excellent release of food during cooking and easy to clean even in the dishwasher.

Un'innovativa superficie caratterizzata da rilievi durissimi che proteggono il rivestimento con resistenza ai graffi 3 volte superiore. La conformazione rugosa aumenta la superficie di scambio e la conducibilità termica, permettendo cotture uniformi e risparmio di energia. Perfetta antiaderenza: ottimo rilascio del cibo in cottura e facile da pulire anche in lavastoviglie.



Frypan, non stick, cast iron handle
Padella bombata antiaderente, manico ferro
Bratpfanne, nichttaftend, Gusseisen-Stiel
Poêle bombé, anti-adhérente, queue fonte
Sartén antiaderente, mango hierro

art.	Ø cm.	h. cm.
16113-20	20	5,5
16113-24	24	6,5
16113-28	28	7,0
16113-32	32	7,5
16113-36	36	8,0
16113-40	40	8,5



Frypan, non stick, cast iron handle
Padella antiaderente, manico ferro
Bratpfanne, nichttaftend, Gusseisen-Stiel
Poêle, anti-adhérente, queue fonte
Sartén antiaderente, mango hierro

art.	Ø cm.	h. cm.
16717-20	20	4,0
16717-24	24	5,0
16717-28	28	5,0
16717-32	32	5,3
16717-36	36	6,0
16717-40	40	7,0



Crêpes pan, non stick
Padella crêpes, antiaderente
Crêpepfanne, nichttaftend
Poêle à crêpes, anti-adhérente
Sartén crêpes antiaderente

art.	Ø cm.
16118-24	24



Non-stick blinis pan
Padella per blini, antiaderente
Blinis-Pfännchen, nichttaftend
Poêle à blinis, anti-adhérente
Sartén blinis, antiaderente

art.	Ø cm.	h. cm.
16719-12	12	2



Crêpes pan, non-stick

Padella crêpes antiaderente
Crêpes-Pfanne, nichtaftend
Tuile à crêpes anti-adhérente
Sartén para crêpes, antiadherente

art.	Ø cm.
16712-22	22
16712-26	26
16712-30	30



Bake roasting pan

Tegame
Pfanne
Plat à four
Rustidera

art.	cm.	h. cm.
16941-40	40x26	7,5
16941-45	45x30	7,5
16941-50	50x30	8,0
16941-61*	61x43	9,0

*For 2/1 GN ovens. – Per forno GN 2/1.



Bake roasting pan

Tegame
Pfanne
Plat à four
Rustidera

art.	cm.	h. cm.
16943-40	40x26	7,5
16943-45	45x30	7,5
16943-50	50x30	8,0
16943-60	60x35	9,0
16943-61*	61x43	9,0

*For 2/1 GN ovens. – Per forno GN 2/1.



Bake roasting, non stick

Tegame, antiaderente
Pfanne, nichtaftend
Plat à four, anti-adhérente
Rustidera antiadherente

art.	cm.	h. cm.
16947-50	50x30	8,0
16947-60	60x35	9,0
16947-61*	61x43	9,0

*For 2/1 GN ovens. – Per forno GN 2/1.



Lid for roasting pans

Coperchio per tegami
Deckel für Bräter
Couvercle pour plaques à rôtir
Tapa para rustidera

art.	cm.
16948-40	40x26
16948-45	45x30
16948-50	50x30
16948-60	60x35
16948-61	61x43



Bake roasting pan

Tegame basso
Pfanne, flach
Plat à four bas
Bandeja horno

art.	cm.	h. cm.
16944-45	45x30	4
16944-50	50x30	4
16944-60	60x35	4



Roasting pan with cover

Brasiera con coperchio
Brasiere mit Deckel
Braisière avec couvercle
Rustidera alta con tapa

art.	cm.	h. cm.	lt.
16965-40	40x26	15	14
16965-50	50x30	15	21



Fish kettle

Pesciera
Fisch-Kochkessel
Poissonnière
Hervidor pescado

art.	cm.	h. cm.	lt.
16939-50	50x15	12	9
16939-60	60x17	13	13
16939-70	70x19	14	18
16939-80	80x24	17	30

Equipped with grid and cover.
Fornita con griglia e coperchio.



Bain-marie pot

Bagnomaria
Wasserbadkasserolle
Casserole bain-marie
Baño maria

art.	Ø cm.	h. cm.	lt.
16910-14	14	16	2,5
16910-16	16	18	3,7
16910-18	18	20	5,0
16910-20	20	22	7,0

STEEL FRYING PANS PADELLE FERRO



Iron is ideal for cooking at high temperatures because its low capacity of heat transmission prevents temperature leaps. As it is non-stick, food does not stick to it. It withstands very high temperatures and improves its performance with use. Iron pans are perfect for fried food, omelettes or fine crêpes. Wash the black iron pan in water as little as possible and always keep it greased. Iron pans are ideal also for cooking on induction hobs.

Il ferro è ottimo per le cotture a fuoco molto vivo perché, non avendo un'alta capacità di trasmettere calore, evita improvvisi sbalzi di temperatura. Essendo un materiale antiaderente, evita l'attaccamento dei cibi. Sopporta temperature elevatissime e col tempo migliora il suo rendimento. I recipienti in ferro sono i più adatti per frittture, omelette o sottili crêpes. La padella in ferro nera va lavata con acqua il meno possibile e mantenuta sempre unta. Il ferro è il materiale ideale anche per cotture a induzione.



Blacksteel fish pan
Padella ovale
Fischeisenpfanne, oval
Coupe ovale
Sartén oval

art.	cm.	h. cm.
41719-36	36x26	5,0
41719-40	40x28	5,5



Blacksteel crêpes pan
Padella crêpes
Crêpes Eisenpfanne
Coupe lyonnaise à crêpes
Sartén crêpes

art.	Ø cm.	h. cm.
11718-20	20	2
11718-22	22	2
11718-24	24	2



Blinis pan
Padella per blini
Blinis-Eisenpfännchen
Poêle à blinis
Sartén blinis

art.	Ø cm.	h. cm.
11715-12	12	2



Heavy blacksteel frypan
Padella lionese, pesante
Schwere Eisenpfanne
Coupe lyonnaise extra-forte
Sartén honda pesada

art.	Ø cm.	h. cm.
11714-20	20	3,8
11714-22	22	4,0
11714-24	24	4,5
11714-26	26	4,5
11714-28	28	4,5
11714-32	32	5,0
11714-36	36	5,5
11714-40	40	5,5
11714-45	45	5,5
11714-50	50	6,0



Blacksteel frypan
Padella lionese
Eisenpfanne
Coupe lyonnaise
Sartén honda

art.	Ø cm.	h. cm.
11716-16	16	4,0
11716-20	20	4,5
11716-22	22	4,5
11716-24	24	5,0
11716-26	26	5,5
11716-28	28	5,5
11716-32	32	6,0
11716-36	36	6,5
11716-40	40	7,0
11716-45	45	8,0



Blacksteel paella pan
Padella per paella
Paella Eisenpfanne
Coupe lyonnaise à paella
Paellera

art.	Ø cm.	h. cm.
11717-34	34	5,0
11717-37	37	5,5
11717-42	42	6,0
11717-47	47	6,5
41717-60	60	6,5



Blacksteel fish pan
Padella ovale
Fischeisenpfanne, oval
Coupe ovale
Sartén oval

art.	cm.
41703-38	38x26



Wok pan
Wok
Wok-Pfanne
Poêle chinoise
Wok

art.	Ø cm.	h. cm.
11713-32	32	10
11713-40	40	11



Silicone sleeve
Coprimanico silicone
Silikon-Stielhülle
Revêtement manche en silicone
Cubre mango silicona

art.	Ø cm.	col.
11710-AA	20-36	●
11710-AB	40-50	●

Heat resistant up to 230°C. Resistenza al calore fino a 230°C. Suits items! Per art: 16717, 16113, 16712, 11714, 11716, 11718, 11713, 11721.



Fry pan
Padella per friggere
Frittier-Pfanne
Tuile à frire
Sartén freidora

art.	Ø cm.	h. cm.	lt.
41707-32	32	9,8	6,0
41707-36	36	11,0	8,8
41707-40	40	13,4	12,2
41707-45	45	15,0	17,3
41707-50	50	17,6	23,5



Wire basket
Cestello per friggere
Frittier-Rost
Grille à frire
Cesta escurrefrito

art.	Ø cm.	h. cm.
41708-32	29,5	8,7
41708-36	32,6	9,3
41708-40	39,0	12,4
41708-45	43,0	15,0
41708-50	46,5	17,0

ENAMELLED CAST IRON GHISA SMALTATA

COOKWARE
PENTOLAME



Suitable for use on all cooking hobs (gas, electric, ceramic, induction) and ovens (gas, oil, coal or wood) except microwave. A perfect harmony of cast iron, enamel and high quality. Designed and constructed to absorb and spread the heat evenly. Cast iron is suitable for all cooking techniques, for soups, roasts, rice, desserts, for braise that require a long cooking and likewise ideal for meats and grilled vegetables as it enhances flavors and aromas like barbecue style. Cast iron also features non-stick. The high temperature of the pan sears the meat surface. All the flavor, water and nutritional values remain sealed in the food. When cooking in casseroles, the steam generated thanks to the special design of the cover condenses falling back into the food not only retaining flavors and aromas but providing the best protection for nutrients and contributing to a healthy diet. Cast iron is a material 100% recyclable and therefore environmentally friendly. Moreover, thanks to its ability to retain heat for a long time it allows a considerable saving of energy. With closed lid on the table, the pot will preserve the temperature for a second serving. Cast iron retains the heat but as well the cold... can be used to keep the food fresh. Stored for a short time in the refrigerator, keeps food cool during hot summer days, ideal for serving pasta or rice salads, etc. Practical and easy to clean. These cast iron pots and pans are dishwasher safe thanks to the special technology applied to their enameling method. Ergonomic knobs and handles made of cast iron and stainless steel, suitable for use on all heat sources and ovens except microwave. Be careful, they heat up during cooking, it is recommended to handle with a dry thick cloth.

Idonee all'uso su tutte le fonti di cottura (gas, elettriche, vetroceramica, induzione) e forni (gas, petrolio, carbone o legna) ad esclusione di microonde. Una perfetta armonia tra ghisa, smalto e alta qualità. Progettate e costruite per assorbire e diffondere il calore in modo uniforme. La ghisa è adatta a tutte le tecniche di cottura, per zuppe, arrostiti, risotti, dolci, per piatti che richiedono una lunga cottura tipo brasati e allo stesso modo ideale per carni e verdure alla griglia in quanto ne esalta sapori ed aromi in stile barbecue. La ghisa ha anche caratteristiche di antiaderenza. La temperatura elevata della padella cauterizza la superficie della carne. Tutto il sapore, l'acqua e i valori nutrizionali rimangono sigillati nel cibo. Nella cottura in casseruole, il vapore generato grazie al particolare design del coperchio si condensa ricadendo e mescolandosi nuovamente nel cibo non solo trattenendo sapori e aromi ma fornendo la miglior protezione alle sostanze nutrienti e contribuendo ad una dieta sana. La ghisa è un materiale riciclabile al 100% e quindi ecologico. Inoltre, grazie alla sua capacità di mantenere il calore per lungo tempo consente un notevole risparmio di energia permettendo di cuocere a fuoco basso. Anche a tavola mantengono in cibi in temperatura. La ghisa mantiene però il caldo come pure il freddo... può essere usata per mantenere il cibo fresco. Riposta per un breve periodo in frigorifero, mantiene il cibo fresco nelle calde giornate estive e ideale per servire insalate di pasta, riso, farro, ecc., ecc. Pratica e facile da pulire. Queste casseruole e padelle in ghisa sono lavabili in lavastoviglie, per merito della speciale tecnologia applicata al metodo di smaltatura. Manicatura e pomoli dal design ergonomico sono in ghisa e inox. Durante la cottura si raccomanda di maneggiare con un panno consistente e asciutto per evitare di scottarsi.



SERIES ANATOLIA



Enamelled cast iron 3 coats, 2 fires.
Material thickness: bottom 4 mm, edges 3,5 mm.

Ghisa smaltata 3 strati di rivestimento antiaderente, doppia cottura.
Spessore materiale: fondo 4 mm, bordi 3,5 mm.



NEW

Saucepot with lid
Casseruola alta con coperchio
Fleischtopf mit Deckel
Brasière avec couvercle
Cacerola alta con tapa

art.	Ø cm.	h. cm.	lt.	Por.
44275B26	26	11,5	4,35	4-6



NEW

Saucepot with lid
Casseruola alta con coperchio
Fleischtopf mit Deckel
Brasière avec couvercle
Cacerola alta con tapa

art.	Ø cm.	h. cm.	lt.	Por.
44275A26	26	11,5	4,35	4-6



NEW

Saucepot with lid
Casseruola alta con coperchio
Fleischtopf mit Deckel
Brasière avec couvercle
Cacerola alta con tapa

art.	Ø cm.	h. cm.	lt.	Por.
44275G26	26	11,5	4,35	4-6



Saucepot with lid

Casseruola alta con coperchio
Fleischtopf mit Deckel
Brasière avec couvercle
Cacerola alta con tapa

art.	Ø cm.	lt.	Por.
44201R16	16	1,0	1-2
44201R20	20	2,6	2-3
44201R24	24	4,5	4-5
44201R28	28	6,7	6-8
44201R32	32	10,0	12-16



Saucepot with lid

Casseruola alta con coperchio
Fleischtopf mit Deckel
Brasière avec couvercle
Cacerola alta con tapa

art.	Ø cm.	lt.	Por.
44201N16	16	1,0	1-2
44201N20	20	2,6	2-3
44201N24	24	4,5	4-5
44201N28	28	6,7	6-8
44201N32	32	10,0	12-16



W

Platter with magnetic feature

Sottopentola magnetico
Untersetzer, magnetisch
Sous-plat magnétique
Posavasos magnético

art.	Ø cm.
44207-20	20

Beechwood. – Faggio.



Casserole pot with glass lid

Casseruola bassa coperchio vetro
Bratentopf mit Glasdeckel
Sautoir avec couvercle verre
Cacerola baja con tapa vidrio

art.	Ø cm.	lt.	Por.
44204R24	24	2,4	4
44204R28	28	3,4	4-6



NEW

Casserole pot with lid

Casseruola bassa coperchio
Bratentopf mit Deckel
Sautoir avec couvercle
Cacerola baja con tapa

art.	Ø cm.	h. cm.	lt.	Por.
44204R32	32	9	5,7	6-8



NEW

Mini wok

Mini wok
Mini-Wok
Mini wok
Mini wok

art.	Ø cm.	h. cm.	lt.	Por.
44270-16	16	8	0,75	1



Oval saucepan with lid

Casseruola ovale con coperchio
Ovaler Bratentopf mit Deckel
Casserole ovale avec couvercle
Cacerola oval con tapa

art.	Ø cm.	lt.	Por.
44202R29	29	4,8	6



Oval saucepan with lid

Casseruola ovale con coperchio
Ovaler Bratentopf mit Deckel
Casserole ovale avec couvercle
Cacerola oval con tapa

art.	Ø cm.	lt.	Por.
44202N25	25	3,3	4
44202N29	29	4,8	6





Terrine pot
Terrina
Pasteten-Pfanne
Terrine rectangle
Fuente rectangular

art.	cm.	lt.	Por.
44219R26	11x33x10	1,05	2-4



Bread pot
Teglia pane
Brottopf
Terrina à pain
Olla para pan

art.	cm.	lt.	Por.
44219R31	13x31x10	2,13	2-4



NEW

Bread pot
Teglia pane
Brottopf
Terrina à pain
Olla para pan

art.	Ø cm.	h. cm.	lt.	Por.
44219R24	24	10,8	3,56	4-6



NEW

Baking tray
Teglia
Backblech
Plat à four
Plato horno

art.	Ø cm.	h. cm.	lt.
44253-30	30	5	2,72



Grill pan
Padella grill
Grill-Pfanne
Poêle grill
Sartén grill

art.	cm.	lt.	Por.
44209R26	26x26	2,2	4
44209R32	26x32	2,6	6



NEW

Grill pan divided
Padella grill divisa
Grill-Pfanne geteilt
Poêle grill divisée
Sartén grill dividida

art.	cm.	h. cm.	lt.	Por.
44211R03	26x30	5,5	2,38	2



NEW

Grill pan
Padella grill
Grill-Pfanne
Poêle grill
Sartén grill

art.	cm.	h. cm.	lt.	Por.
44211R01	26x26	5,5	2,51	4-6



NEW

Grill pan divided

Padella grill divisa
Grill-Pfanne geteilt
Poêle grill divisée
Sartén grill dividida

art.	cm.	h. cm.	lt.	Por.
44211R02	26x30	5,5	2,68	4-6



Grill pan

Padella grill
Grill-Pfanne
Poêle grill
Sartén grill

art.	cm.	lt.	Por.
44210-26	26x26	2,20	4
44210-32	26x32	2,75	6



Grill pan with wooden service stand

Padella grill con tagliere a servire legno
Grill-Pfanne mit Service-Holzbrett
Poêle grill avec support à servir bois
Sartén grill con tabla madera

art.	cm.	lt.	Por.
44210S32	26x32	2,75	6

Beechwood. – Faggio.



Grill pan

Padella grill
Grill-Pfanne
Poêle grill
Sartén grill

art.	cm.	lt.	Por.
44210-42	31x42	4,5	8



Bake roasting dish

Tegame rettangolare
Pfanne, rechteckig
Plat rectangulaire
Rustidera

art.	cm.	Por.
44218R30	22x30	6-8
44218R40	26x40	8-12



Grill pan

Bistecchiera
Grill-Pfanne
Poêle grill
Sartén grill

art.	Ø cm.	lt.	Por.
44212-30	30	2,35	4-6



Grill pan

Bistecchiera
Grill-Pfanne
Poêle grill
Sartén grill

art.	Ø cm.	Por.
44214-25	25	2-3



NEW

Grill pan

Padella grill
Grill-Pfanne
Poêle grill
Sartén grill

art.	Ø cm.	h. cm.	Por.
44252-32	32	6	6-8

Silicone sleeve. – Coprimanico silicone.



Grill pan

Bistecchiera
Grill-Pfanne
Poêle grill
Sartén grill

art.	cm.	Por.
44213-24	24x24	1-2
44213-36	21x36	2-4



Griddle plate, dual side, reversible

Griglia reversibile
Grill-Platte, zweiseitig, reversible
Grill rectangle, reversible
Parrilla reversible

art.	cm.	Por.
44224-22	22x15	1-2



Griddle plate, dual side, reversible

Griglia reversibile
Grill-Platte, zweiseitig, reversible
Gril rectangle, reversible
Parrilla reversible

art.	cm.	Por.
44217-45	26x47	6-8



Grill plate and wooden platter

Griglia reversibile con tagliere legno
Grill-Platte mit Service-Holzbrett
Grill avec plaque à servir bois
Parrilla con tabla madera

art.	cm.	Por.
44224S22	22x15	1-2

Beechwood. – Faggio.



Griddle with wooden platter

Griglia con tagliere legno
Grill-Platte mit Holzbrett
Grill rectangle avec planche bois
Parrilla con tabla madera

art.	cm.	Por.
44226S30	22x30	2-3

Beechwood. – Faggio.



Table barbecue

Barbecue da tavola
Tischgrillplatte
Barbecue de table
Parrilla de mesa

art.	cm.	Por.
44225-22	22x15	1-2

Fuel holder not included. See item 44220-AA.
Portacombustibile non incluso. Vedi codice 44220-AA.



Table barbecue

Barbecue da tavola
Tischgrillplatte
Barbecue de table
Parrilla de mesa

art.	cm.	Por.
44227-30	22x30	2-3

Fuel holder not included. See item 44220-AA.
Portacombustibile non incluso. Vedi codice 44220-AA.





Grill pan and wooden service stand
Padella grill con tagliere a servire legno
Grill-Pfanne mit Service-Holzbrett
Poêle grill avec plaque à servir bois
Sartén grill con tabla madera

art. cm. Por.
44216S16 16x16 1

Cups not included. – Ciotoline non incluse.



Grill pan with wooden platter
Padella grill con tagliere legno
Grill-Pfanne mit Holzbrett
Poêle grill avec planche bois
Sartén grill con tabla madera

art. cm. Por.
44215S16 16x16 1

Beechwood. – Faggio.



Fajita plate with wooden platter
Piatto fajita con tagliere legno
Fajitaplatte mit Holzbrett
Plat à fajitas avec planche bois
Fuente fajitas con tabla madera

art. cm. Por.
44228S23 17x23 1

Beechwood. – Faggio.



Fish plate with wooden platter
Piatto pesce con tagliere legno
Fischplatte mit Holzbrett
Plat à poisson avec planche bois
Fuente pescado con tabla madera

art. cm. Por.
44220S24 15x24 1-2

Beechwood. – Faggio.



Fish plate with wooden platter
Piatto pesce con tagliere legno
Fischplatte mit Holzbrett
Plat à poisson avec planche bois
Fuente pescado con tabla madera

art. cm. Por.
44221S30 15,5x29,5 1-2

Beechwood. – Faggio.



Pizza pan with wooden platter
Piatto pizza con tagliere legno
Pizza-Platte mit Holzbrett
Plat à pizza avec planche bois
Fuente para pizza con tabla madera

art. Ø cm. Por.
44222S20 20 1
44222S28 28 1

Beechwood. – Faggio.



Oval plate with wooden platter
Piatto ovale con tagliere legno
Ovalplatte mit Holzbrett
Plat oval avec planche bois
Fuente ovale con tabla madera

art. cm. Por.
44230S14 21x14x2,5 1-2

Beechwood. – Faggio.



Round plate with wooden platter
Piatto tondo con tagliere legno
Platte mit Holzbrett, rund
Plat rond avec planche bois
Fuente redonda con tabla madera

art. Ø cm. Por.
44232S16 16 1-2
44232S20 20 2-3

Beechwood. – Faggio.



Round plate with wooden platter
Piatto tondo con tagliere legno
Platte mit Holzbrett, rund
Plat rond avec planche bois
Fuente redonda con tabla madera

art. Ø cm. lt. Por.
44233-20 20 0,74 3-4

Cups not included. – Ciotoline non incluse.



Rectangular pan with wooden service stand

Tegame con tagliere a servire legno
Pfanne mit Service-Holzbrett
Poêle avec support à servir bois
Sartén con tabla madera

art. cm. Por.
44237S15 12x15 1-2

Beechwood. – Faggio.



Service dish with wooden stand

Piatto servire con tagliere legno
Servierplatte mit Holzbrett
Plat à servir avec support en bois
Plato para servir con tabla madera

art. cm. Por.
44245S32 32x20 1

Beechwood. – Faggio.



Service dish with wooden stand

Piatto servire con tagliere legno
Servierplatte mit Holzbrett
Plat à servir avec support en bois
Plato para servir con tabla madera

art. cm. Por.
44244S36 36x24 4-6

Beechwood. – Faggio.



Round pan

Padella tonda
Pfanne, rund
Poêle ronde

Sartén grill redonda

art. Ø cm. h. cm. Por.
44234-12 12 1
44234-16 16 1-2



Pan and wooden platter

Padella con tagliere legno
Pfanne mit Holzbrett
Poêle avec plache bois
Sartén grill con tabla madera

art. Ø cm. h. cm. Por.
44234S16 16 0,45 1-2

Beechwood. – Faggio.



Hot pot with wooden stand

Casseroola con tagliere legno
Schüssel mit Holzbrett
Bol avec support en bois
Bol con tabla madera

art. Ø cm. h. cm. lt. Por.
44246S14 14 4 0,32 1
44246S17 17 4 0,59 1

Beechwood. – Faggio.



NEW

Three divided dish

Piatto tre scomparti
Platte 3 Fächer
Assiette 3 compartiments
Plato tres compartimentos

art. cm. h. cm. lt. Por.
44271-33 12x33 4,5 0,75 3

Beechwood. – Faggio.



NEW

Serving dish

Piatto servire
Servierplatte
Plat à servir
Plato para servir

art. cm. h. cm. lt. Por.
44220S15 15x26 3,8 0,29 1

Beechwood. – Faggio.



Pan with wooden platter

Tegame con tagliere legno
Pfanne mit Holzbrett
Poêle avec plaque bois
Paellera con tabla madera

art.	Ø cm.	cm.	lt.	Por.
44247S16	16	23,5x18,5	0,44	1-2

Beechwood. – Faggio.



Soufflé pot with wooden platter

Coppa soufflé con supporto legno
Ramekin mit Holzbrett
Ramequin avec planche bois
Fuente soufflé con tabla madera

art.	Ø cm.	lt.	Por.
44240S08	8	0,15	1

Beechwood. – Faggio.



Soufflé pot

Coppa soufflé
Ramekin
Ramequin
Fuente soufflé

art.	Ø cm.	h. cm.	lt.
44240-08	8	4,5	0,15

Enamelled cast iron. – Ghisa smaltata.



W

Tortillas cup

Ciotola tortillas
Tortillas-Schale
Coupe-tortillas
Copa tortillas

art.	Ø cm.
44241-19	19

Iroko wood. – Legno iroko.



PR

Sauce bowl

Coppa salsa
Saucentasse
Bol à sauce
Copa para salsa

art.	Ø cm.	h. cm.
44242-00	6	2,7

Porcelain. – Porcellana.



MF

Sauce bowl

Coppa salsa
Saucentasse
Bol à sauce
Copa para salsa

art.	Ø cm.	h. cm.
44243-00	7,1	3,5

Melamine. – Melamina.



Silicone sleeves

Coprimaniglia silicone
Silikon-Griffhüllen
Revêtement en silicone pour poignées
Cubre asas de silicona

art.	col.
44208G00	●
44208R00	●



SS

Fuel holder

Portacombustibile
Brennstoffhalterung
Porte Brûleur
Contenedor de combustible

art.	cm.	h. cm.
44220-AA	9,3x14,9	4,8



NEW

Hot pot with wooden stand

Casseruola con tagliere legno
Schüssel mit Holzbrett
Bol avec support en bois
Bol con tabla madera

art.	Ø cm.	h. cm.	lt.	Por.
44272-11	11	5,5	0,22	1
44272-14	14	5,5	0,36	1
44272-17	17	5,5	0,44	1-2

Beechwood. – Faggio.



NEW

Fish plate with wooden platter

Piatto pesce con tagliere legno
Fischplatte mit Holzbrett
Plat à poisson avec planche bois
Fuente pescado con tabla madera

art.	cm.	h. cm.	lt.	Por.
44273-24	15x24	5	0,44	1-2
44273-32	20x32	5	1,10	2

Beechwood. – Faggio.



NEW

Fajita plate with wooden platter

Piatto fajita con tagliere legno
Fajitaplatte mit Holzbrett
Plat à fajitas avec planche bois
Fuente fajitas con tabla madera

art.	cm.	h. cm.	lt.	Por.
44274-24	18x24	4	0,55	1

Beechwood. – Faggio.

MISCELLANEOUS COMPLEMENTI

STAINLESS STEEL COOKWARE
PENTOLAME INOX

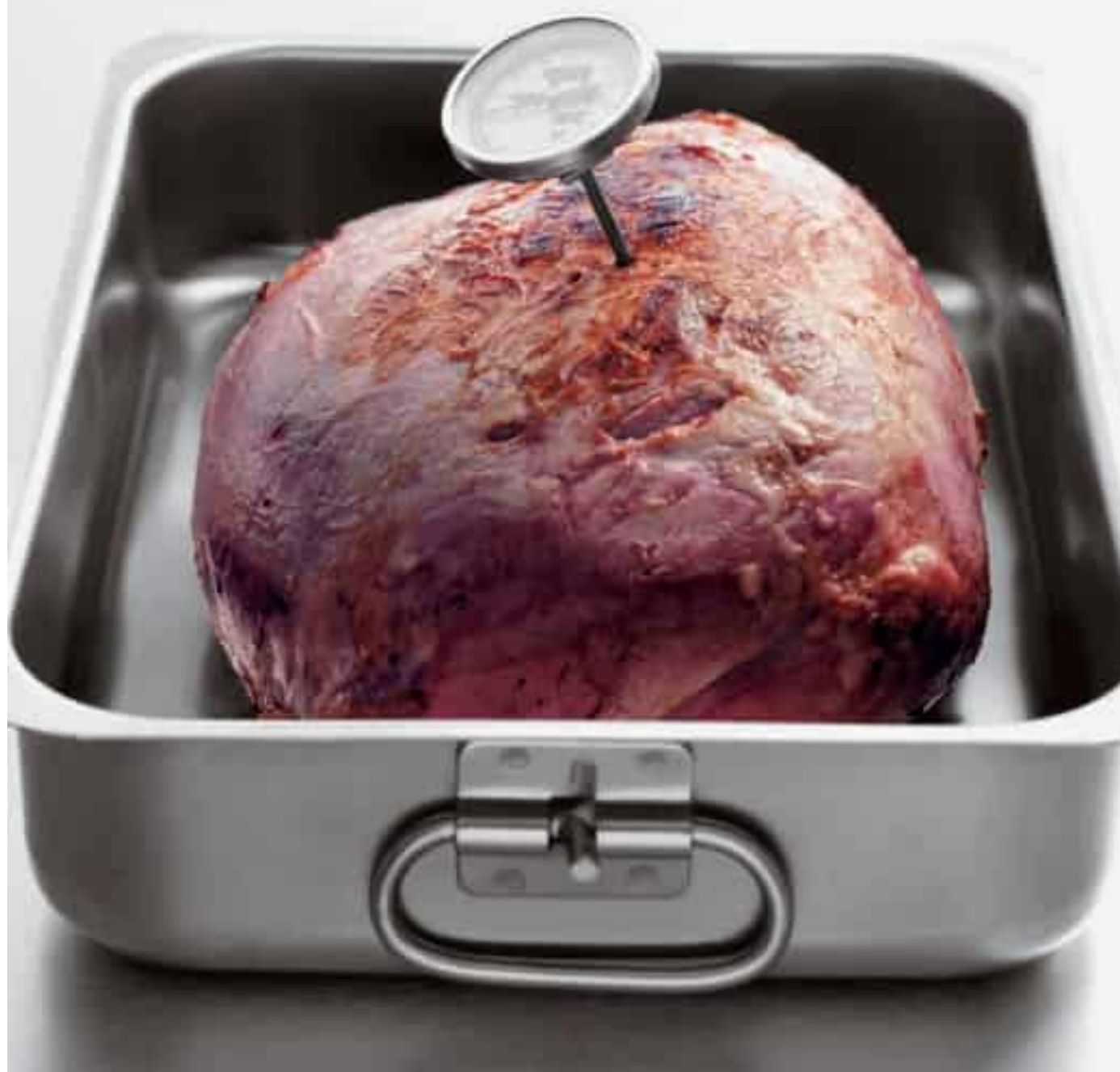



Roasting pan

Tegame
Bräter
Plaque à rôtir
Rustidera

art.	cm.	h. cm.
11941-35	35x25	8
11941-40	40x26	9
11941-45	45x30	9
11941-50	50x30	9
11941-60	60x35	9



Heavy roasting pan

Tegame pesante
Bräter, Schwerausführung
Plaque à rôtir lourde
Rustidera pesada

art.	cm.	h. cm.
11943-40	40x26	9
11943-45	45x30	9
11943-50	50x30	9
11943-60	60x35	9
11943-61*	61x43	9

***For 2/1 GN ovens. – Per forno GN 2/1.**



Heavy roasting pan

Tegame pesante
Bräter, Schwerausführung
Plaque à rôtir lourde
Rustidera pesada

art.	cm.	h. cm.
11944-40	40x26	9
11944-45	45x30	9
11944-50	50x30	9
11944-60	60x35	9
11944-61*	61x43	9

***For 2/1 GN ovens. – Per forno GN 2/1.**



Lid

Coperchio
Deckel
Couvercle
Tapa

art.	cm.
11948-40	40x26
11948-45	45x30
11948-50	50x30
11948-60	60x35
11948-61*	61x43

***For 2/1 GN ovens. – Per forno GN 2/1.**



Roasting pan with lid

Brasiera con coperchio
Brasiere mit Deckel
Braisinge avec couvercle
Rustidera alta con tapa

art.	cm.	h. cm.
11965-50	50x30	15
11965-60	60x35	15
11965-61*	61x43	15

***For 2/1 GN ovens. – Per forno GN 2/1.**



Fry dripping tray, stainless steel

Colafritto, inox
Pommes-Frites-Seiher, Edelstahl Rostfrei
Egouttoir à friture, inox
Escurridor para fritura, inox

art.	Ø cm.	h. cm.
41930-39	41	14

Detachable drip tray.

Vassoio raccogli liquidi removibile.



**INDUCTION
READY!**

Fish kettle

Pesciera
Fischkochkessel
Poissonnière
Hervidor pescado

art.	cm.	h. cm.
41964-45	46x15,5	10,5
41964-60	61,5x18,5	11,0

Equipped with grid and cover.

Fornita con griglia e coperchio.





Whistling kettle
Bollitore
Kocher
Bouilloire à sifflet
Pava

art.	Ø cm.	h. cm.	lt.
41914-03	20	18	2,8



Canister
Contentore cilindrico
Behälter
Bahut
Contenedor cilíndrico

art.	Ø cm.	h. cm.	lt.
11913-16	16	12	2,4
11913-20	20	16	5,0
11913-24	24	20	9,0
11913-28	28	24	14,5



Bain-marie pot
Casseruola bagnomaria
Wasserbadkasserolle
Casserole bain-marie
Baño maria

art.	Ø cm.	h. cm.	lt.
11910-12	12	14	1,4
11910-14	14	16	2,5
11910-16	16	18	3,6
11910-18	18	20	5,0
11910-20	20	22	7,0



Bain-marie pot
Bagnomaria
Behälter
Casserole bain-marie
Baño maria

art.	Ø cm.	h. cm.	lt.
11911-12	12	14	1,4
11911-14	14	16	2,5
11911-16	16	18	3,6
11911-18	18	20	5,0
11911-20	20	22	7,0



Bain-marie, stackable
Bagno-maria impilabili
Bain-Marie, stapelbar
Bain-marie, empilables
Baño maria, apilable

art.	cm.	h. cm.	lt.
44501-01	24x24	23,5	13,0
44501-02	24x24	16,0	9,0
44501-03	24x24	7,5	4,0



Bain-marie, stackable
Bagno-maria impilabili
Bain-Marie, stapelbar
Bain-marie, empilables
Baño maria, apilable

art.	cm.	h. cm.	lt.
44502-01	15,5x15,5	23,5	5,0
44502-02	15,5x15,5	16,0	3,5
44502-03	15,5x15,5	7,5	1,5



Bain-marie, stackable
Bagno-maria impilabili
Bain-Marie, stapelbar
Bain-marie, empilables
Baño maria, apilable

art.	cm.	h. cm.	lt.
44503-01	15,5x10,5	16,0	2,5
44503-02	15,5x10,5	7,5	1,0
44503-03	15,5x10,5	5,5	0,5



Bain-marie lid
Coperchio bagnomaria
Wasserbadkasserolle-Deckel
Couverte pour bain-marie
Tapa para baño maria

art.	cm.
44501-04	24x24
44502-04	15,5x15,5
44503-04	15,5x10,5



1/4-Segment colander
Colapasta 1/4
1/4 Seiher-Einsatz
Passoire cuit-pâtes, 1/4
Colador 1/4

art.	Ø cm.	h. cm.	lt.
11922-36	36	23	5,5
11922-40	40	26	7,5

For items/Per art.:
11007-11107-12007-12107-16929.

OVEN COOKING DISHES PIROFILE FORNO

PORCELAIN
PORCELLANA



Only use in the oven or microwave oven, do not place on direct flame.

Per uso in forni tradizionali e microonde, non mettere le porcellane a diretto contatto con la fiamma.



Oval dish, fluted

Pirofila ovale cordonata
Schale, oval, gerippt
Plat ovale, cannelé
Fuente oval borderizata

art.	cm.
44371-24	24x14x4
44371-28	28x16x4,5
44371-32	32,5x18x5
44371-36	36,5x19,5x5
44371-40	41x23x5,5
44371-44	44x26,5x5,7
44371-48	48x28,5x6,5



Round dish, fluted

Pirofila rotonda cordonata
Schale, rund, gerippt
Plat rond, cannelé
Fuente redonda borderizata

art.	Ø cm.
44372-26	26,5
44372-32	32,0
44372-36	36,0
44372-40	40,0



Rectangular dish, fluted

Pirofila rettangolare cordonata
Schale, rechteckig, gerippt
Plat rectangulaire, cannelé
Fuente rectangular borderizata

art.	cm.
44374-22	22x16x6
44374-25	25x20x7
44374-32	32x22x6
44374-36	36x24x6
44374-40	40x26x6
44374-44	44x32x6



Rectangular dish, low, fluted

Rettangolare cordonata, bassa
Schale, rechteckig, flach, gerippt
Plat rectangulaire, cannelé
Fuente rect. borderizata, baja

art.	cm.
44376-40	40x30x4



Square dish, fluted

Pirofila quadra cordonata
Schale, quadratisch, gerippt
Plat carré, cannelé
Fuente cuadrada borderizata

art.	cm.
44375-25	25x25x6



Soup bowl with cover

Casseruola con coperchio
Kasserolle mit Deckel
Casserole avec couvercle
Cacerola con tapa

art.	cm.	lt.
44397-18	14x18	0,5



Escargot dish

Tegame lumache
Schneckenplatte
Plat à escargots
Plato caracoles

art.	Ø cm.
44378-06	19



Egg dish, fluted

Tegamino cordonato
Schale, gerippt
Plat à oeufs, cannelé
Fuente huevo borderizata

art.	cm.
44394-18	18x21,0
44394-21	21x24,5



Egg dish, high, fluted

Tegamino fondo, cordonato
Schale, tief, gerippt
Plat oeuf, creux, cannelé
Fuente soufflé borderizata, alta

art.	cm.
44395-18	18x20



Creme broulée bowl

Coppetta creme broulée
Crème broulée Schale
Coupelle broulée à crème
Bol creme broulée

art.	Ø cm.	h. cm.
44391-12	11,6	3



Ramekin, fluted

Soufflé cordonato
Ramekin, gerippt
Ramequin, cannelé
Fuente soufflé borderizata

art.	Ø cm.	h. cm.
44390-07	7	4,0
44390-09	9	4,5
44390-11	11	6,0



Ramekin, fluted

Soufflé cordonato
Ramekin, gerippt
Ramequin, cannelé
Fuente soufflé borderizata

art.	Ø cm.	h. cm.
44390-15	15	5,0
44390-18	18	7,5
44390-23	23	8,0

GN FOOD PANS CONTENITORI GN

STAINLESS STEEL, ALUMINUM, POLYCARBONATE, POLYPROPYLENE, MELAMINE AND PORCELAIN
INOX, ALLUMINIO, POLICARBONATO, POLIPROPILENE, MELAMINA E PORCELLANA



FOOD PANS, STAINLESS STEEL
BACINELLE GASTRONORM, INOX



GN-containers

GN bacinelle
GN-Behälter
GN bacs
GN cubetas

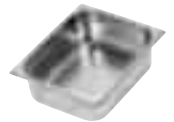

art.	GN	dim. mm.	h. mm.	lt.
14101-02	2/1	650x530	20	-
14101-04	2/1	650x530	40	-
14101-06	2/1	650x530	65	19
14101-10	2/1	650x530	100	31
14101-15	2/1	650x530	150	46
14101-20	2/1	650x530	200	56



art.	GN	dim. mm.	h. mm.	lt.
14102-02	1/1	530x325	20	-
14102-04	1/1	530x325	40	-
14102-06	1/1	530x325	65	9
14102-10	1/1	530x325	100	14
14102-15	1/1	530x325	150	21
14102-20	1/1	530x325	200	28



art.	GN	dim. mm.	h. mm.	lt.
14103-02	2/3	353x320	20	-
14103-04	2/3	353x320	40	-
14103-06	2/3	353x320	65	5,5
14103-10	2/3	353x320	100	9,0
14103-15	2/3	353x320	150	13,0
14103-20	2/3	353x320	200	18,0



art.	GN	dim. mm.	h. mm.	lt.
14104-06	2/4	162x530	65	4,0
14104-10	2/4	162x530	100	5,6
14104-15	2/4	162x530	150	8,7



art.	GN	dim. mm.	h. mm.	lt.
14105-02	1/2	325x265	20	-
14105-04	1/2	325x265	40	-
14105-06	1/2	325x265	65	4,0
14105-10	1/2	325x265	100	6,5
14105-15	1/2	325x265	150	9,5
14105-20	1/2	325x265	200	12,5



art.	GN	dim. mm.	h. mm.	lt.
14107-06	1/3	325x180	65	2,5
14107-10	1/3	325x180	100	4,0
14107-15	1/3	325x180	150	5,7
14107-20	1/3	325x180	200	7,8



art.	GN	dim. mm.	h. mm.	lt.
14108-06	1/4	265x160	65	1,8
14108-10	1/4	265x160	100	2,8
14108-15	1/4	265x160	150	4,0
14108-20	1/4	265x160	200	5,5



art.	GN	dim. mm.	h. mm.	lt.
14109-06	1/6	176x160	65	1,0
14109-10	1/6	176x160	100	1,6
14109-15	1/6	176x160	150	2,4
14109-20	1/6	176x160	200	3,4



art.	GN	dim. mm.	h. mm.	lt.
14110-06	1/9	176x110	65	0,6
14110-10	1/9	176x110	100	1,0



GN-containers, fixed handles

GN bacinelle, maniglie fisse

GN-Behälter mit festen Griffen

GN bacs, anses fixes

GN cubetas, asas fijas

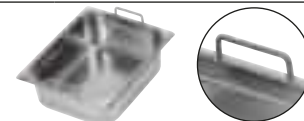

art.	GN	dim. mm.	h. mm.	lt.
14112-10	1/1	530x325	100	14,0
14112-15	1/1	530x325	150	21,0
14112-20	1/1	530x325	200	28,0



art.	GN	dim. mm.	h. mm.	lt.
14115-10	1/2	325x265	100	6,5
14115-15	1/2	325x265	150	9,5
14115-20	1/2	325x265	200	12,5



art.	GN	dim. mm.	h. mm.	lt.
14117-10	1/3	325x180	100	4,0
14117-15	1/3	325x180	150	5,7
14117-20	1/3	325x180	200	7,8



art.	GN	dim. mm.	h. mm.	lt.
14118-10	1/4	265x160	100	2,8
14118-15	1/4	265x160	150	4,0
14118-20	1/4	265x160	200	5,5



art.	GN	dim. mm.	h. mm.	lt.
14119-10	1/6	176x160	100	1,6
14119-15	1/6	176x160	150	2,4



art.	GN	dim. mm.	h. mm.	lt.
14142-20	1/1	530x325	200	28,0



art.	GN	dim. mm.	h. mm.	lt.
14145-10	1/2	325x265	100	6,5
14145-15	1/2	325x265	150	9,5
14145-20	1/2	325x265	200	12,5



art.	GN	dim. mm.	h. mm.	lt.
14147-15	1/3	325x180	150	5,7
14147-20	1/3	325x180	200	7,8



art.	GN	dim. mm.	h. mm.	lt.
14148-10	1/4	265x160	100	2,8
14148-15	1/4	265x160	150	4,0
14148-20	1/4	265x160	200	5,5

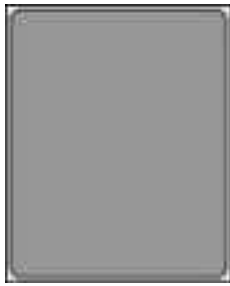

GN-containers, falling handles
GN bacinelle, maniglie rientranti
GN-Behälter mit versenkbaren Griffen
GN bacs, anses escamotables
GN cubetas, asas móviles

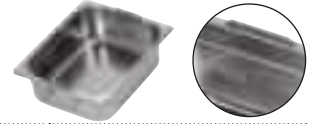

art.	GN	dim. mm.	h. mm.	lt.
14151-10	2/1	650x530	100	31,0
14151-15	2/1	650x530	150	46,0
14151-20	2/1	650x530	200	56,0



art.	GN	dim. mm.	h. mm.	lt.
14152-06	1/1	530x325	65	9,0
14152-10	1/1	530x325	100	14,0
14152-15	1/1	530x325	150	21,0
14152-20	1/1	530x325	200	28,0



art.	GN	dim. mm.	h. mm.	lt.
14155-10	1/2	325x265	100	6,5
14155-15	1/2	325x265	150	9,5
14155-20	1/2	325x265	200	12,5



art.	GN	dim. mm.	h. mm.	lt.
14157-10	1/3	325x180	100	4,0
14157-15	1/3	325x180	150	5,7
14157-20	1/3	325x180	200	7,8



art.	GN	dim. mm.	h. mm.	lt.
14158-10	1/4	265x160	100	2,8
14158-15	1/4	265x160	150	4,0
14158-20	1/4	265x160	200	5,5



art.	GN	dim. mm.	h. mm.	lt.
14159-10	1/6	176x160	100	1,6
14159-15	1/6	176x160	150	2,4
14159-20	1/6	176x160	200	3,4

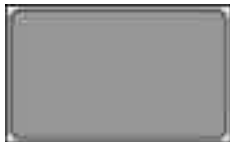

GN-containers non stick coated
GN bacinelle antiaderenti
GN-Behälter mit Antihafbeschichtung
GN-bacs avec revêtement anti-adhésif
GN-cubetas con cobertura antiadherente



art.	GN	dim. mm.	h. mm.
14162-02	1/1	530x325	20
14162-04	1/1	530x325	40
14162-06	1/1	530x325	65



art.	GN	dim. mm.	h. mm.
14165-02	1/2	325x265	20
14165-04	1/2	325x265	40
14165-06	1/2	325x265	65



Perforated GN-containers

GN bacinelle forate
Gelochte GN-Behälter
GN bacs perforés
GN cubetas perforados

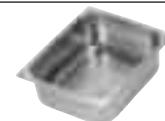

art.	GN	dim. mm.	h. mm.
14201-02	2/1	650x530	20
14201-04	2/1	650x530	40
14201-06	2/1	650x530	65
14201-10	2/1	650x530	100
14201-15	2/1	650x530	150
14201-20	2/1	650x530	200

Containers depth mm 20 and 40 only bottom perforated. – Bacinelle profondità mm 20 e 40 forate solo sul fondo.



art.	GN	dim. mm.	h. mm.
14202-02	1/1	530x325	20
14202-04	1/1	530x325	40
14202-06	1/1	530x325	65
14202-10	1/1	530x325	100
14202-15	1/1	530x325	150
14202-20	1/1	530x325	200

Containers depth mm 20 and 40 only bottom perforated. – Bacinelle profondità mm 20 e 40 forate solo sul fondo.



art.	GN	dim. mm.	h. mm.
14203-06	2/3	353x320	65
14203-10	2/3	353x320	100
14203-15	2/3	353x320	150
14203-20	2/3	353x320	200

Containers depth mm 20 and 40 only bottom perforated. – Bacinelle profondità mm 20 e 40 forate solo sul fondo.



art.	GN	dim. mm.	h. mm.
14205-02	1/2	325x265	20
14205-04	1/2	325x265	40
14205-06	1/2	325x265	65
14205-10	1/2	325x265	100
14205-15	1/2	325x265	150
14205-20	1/2	325x265	200

Containers depth mm 20 and 40 only bottom perforated. – Bacinelle profondità mm 20 e 40 forate solo sul fondo.



Perforated GN-containers, folding handles

GN bacinelle forate, maniglie snodate
Gelochte GN-Behälter mit Fallgriffen
GN bacs perforés, anses pliantes
GN cubetas perforados, asas plegables

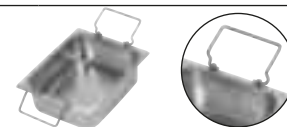

art.	GN	dim. mm.	h. mm.
14252-06	1/1	530x325	65
14252-10	1/1	530x325	100
14252-15	1/1	530x325	150
14252-20	1/1	530x325	200



art.	GN	dim. mm.	h. mm.
14255-06	1/2	325x265	65
14255-10	1/2	325x265	100
14255-15	1/2	325x265	150
14255-20	1/2	325x265	200



GN-lids

GN coperchi
GN-Deckel
GN couvercles
GN tapas

art.	GN	dim. mm.
14502-00	1/1	530x325
14503-00	2/3	353x320
14504-00	2/4	162x530
14505-00	1/2	325x265
14507-00	1/3	325x180
14508-00	1/4	265x160
14509-00	1/6	176x160
14510-00	1/9	176x110



GN-lids with notched edge for handles

GN coperchi con spacco maniglie
GN-Deckel mit Griffen-Ausschnitt
GN couvercles avec encoche pour anses
GN tapas con orificio asas

art.	GN	dim. mm.
14512-00	1/1	530x325
14515-00	1/2	325x265
14517-00	1/3	325x180
14518-00	1/4	265x160
14519-00	1/6	176x160



GN-lids with notched edge for ladle

GN coperchi con spacco mestolo
GN-Deckel mit Löffel-Ausschnitt
GN couvercles avec encoche pour louche
GN tapas con orificio cacillo

art.	GN	dim. mm.
14522-00	1/1	530x325
14523-00	2/3	353x320
14525-00	1/2	325x265
14527-00	1/3	325x180
14528-00	1/4	265x160
14529-00	1/6	176x160



GN-lids with notched edge for handles/ladle

GN coperchi con spacco maniglie/mestolo
GN-Deckel mit Griffen u. Löffel-Ausschnitt
GN couvercles avec encoche pour anses/louche
GN tapas con orificio asas/cacillo

art.	GN	dim. mm.
14532-00	1/1	530x325
14535-00	1/2	325x265
14537-00	1/3	325x180
14538-00	1/4	265x160
14539-00	1/6	176x160



GN-lids with silicone seal

GN coperchi con guarnizione silicone
GN-Deckel mit Silikondichtung
GN couvercles avec joint silicone
GN tapas con junta de silicona

art.	GN	dim. mm.
14542-00	1/1	530x325
14543-00	2/3	353x320
14545-00	1/2	325x265
14547-00	1/3	325x180
14548-00	1/4	265x160
14549-00	1/6	176x160





GN-lids with notched edge for handles and seal
GN coperchi con spacco maniglie e guarnizione
GN-Deckel mit Griffen-Ausschnitt u. Silikondichtung
GN couvercles avec encoche pour anses et joint
GN tapas con orificio asas y junta

art.	GN	dim. mm.
14552-00	1/1	530x325
14555-00	1/2	325x265



GN-baking sheets
GN-teglie
GN-Backbleche
GN-plaques
GN-bandejas



art.	GN	dim. mm.	h. mm.
14301-02	2/1	650x530	20
14301-04	2/1	650x530	40
14301-06	2/1	650x530	65



art.	GN	dim. mm.	h. mm.
14302-02	1/1	530x325	20
14302-04	1/1	530x325	40
14302-06	1/1	530x325	65



art.	GN	dim. mm.	h. mm.
14303-02	2/3	353x320	20
14303-04	2/3	353x320	40
14303-06	2/3	353x320	65



art.	GN	dim. mm.	h. mm.
14305-02	1/2	325x265	20
14305-04	1/2	325x265	40
14305-06	1/2	325x265	65



GN-baking sheets non stick coated
GN-teglie con rivestimento antiaderente
GN-Backbleche mit Antihafbeschichtung
GN-plaques avec revêtement anti-adhésif
GN-bandejas con cobertura antiadherente



art.	GN	dim. mm.	h. mm.
14362-02	1/1	530x325	20
14362-04	1/1	530x325	40
14362-06	1/1	530x325	65



art.	GN	dim. mm.	h. mm.
14365-02	1/2	325x265	20
14365-04	1/2	325x265	40
14365-06	1/2	325x265	65



GN-baking sheets, ALUMINUM

GN-teglie, ALLUMINIO
GN-Backbleche, ALUMINIUM
GN-plaques, ALUMINIUM
GN-bandejas, ALUMINIO



art.	GN	dim. mm.	h. mm.
16302-02	1/1	530x325	20
16302-04	1/1	530x325	40
16302-06	1/1	530x325	65



art.	GN	dim. mm.	h. mm.
16303-02	2/3	353x320	20
16303-04	2/3	353x320	40
16303-06	2/3	353x320	65



art.	GN	dim. mm.	h. mm.
16305-02	1/2	325x265	20
16305-04	1/2	325x265	40
16305-06	1/2	325x265	65



GN-baking sheets, ALUMINUM non stick coated

GN-teglie, ALLUMINIO antiaderente
GN-Backbleche, ALUMINIUM mit Antihftbeschichtung
GN-plaques, ALUMINIUM avec revêtement anti-adhésif
GN-bandejas, ALUMINIO con cobertura antiaderente



art.	GN	dim. mm.	h. mm.
16362-02	1/1	530x325	20
16362-04	1/1	530x325	40
16362-06	1/1	530x325	65



art.	GN	dim. mm.	h. mm.
16363-02	2/3	353x320	20
16363-04	2/3	353x320	40
16363-06	2/3	353x320	65



art.	GN	dim. mm.	h. mm.
16365-02	1/2	325x265	20
16365-04	1/2	325x265	40
16365-06	1/2	325x265	65



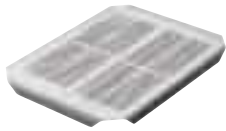

Drainer plate
Falso fondo forato
Abtropfplatte
Plateau double fond perforé
Fondo perforado

art.	GN
14402-00	1/1
14405-00	1/2
14407-00	1/3



Adaptor bar
Separatore
StegeAdapter/Zwischensteg
Barrette de composition
Adaptador

art.	GN	dim. mm.
14409-01	1/1	325
14409-02	2/1	530



Pan, enamelled
Teglia smaltata
Ofenblech, emalliert
Bac émaillé
Cubeta esmaltada

art.	GN	dim. mm.	h. mm.	lt.
44322-02	1/1	530x325	20	2,5
44322-04	1/1	530x325	40	5,0
44322-06	1/1	530x325	65	9,0

Not stackable. – Non impilabili.

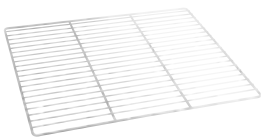

Wire grid
Griglia in filo
Gastronormrost
Grille
Rejilla

art.	GN	dim. mm.
44412-00	1/2	325x265
44423-00	2/3	353x320
44421-00	2/1	650x530



Wire grid
Griglia in filo
Gastronormrost
Grille
Rejilla

art.	GN	dim. mm.
44422-00	1/1	530x325



Wire grid with edge
Griglia in filo con sponda
Gastronormrost mit Seitenwand
Grille avec arrêt
Rejilla con borde

art.	GN	dim. mm.
44432-21	2/1	650x530



Grid enamelled
Griglia smaltata
Rost, emalliert
Grille émaillé
Rejilla esmaltada

art.	GN	dim. mm.
11760-11	1/1	530x325

POLYCARBONATE POLICARBONATO

GN FOOD PANS
CONTENITORI GN



Withstands temperatures from **-40°C to + 100°C**. With metric graduation.
Stackable, ideal for storage, transportation and serving display.

Termoresistenti da **-40°C a +100°C**. Con scala graduata in litri. Impilabili, sono ideali per la conservazione, trasporto ed esposizione.



GN-containers

GN bacinelle
GN-Behälter
GN bacs
GN cubetas

art.	GN	dim. mm.	h. mm.	lt.
14561-15	2/1	650x530	150	42
14561-20	2/1	650x530	200	52



art.	GN	dim. mm.	h. mm.	lt.
14562-06	1/1	530x325	65	8,5
14562-10	1/1	530x325	100	13,0
14562-15	1/1	530x325	150	19,5
14562-20	1/1	530x325	200	26,0



art.	GN	dim. mm.	h. mm.	lt.
14565-06	1/2	325x265	65	3,9
14565-10	1/2	325x265	100	5,9
14565-15	1/2	325x265	150	8,9
14565-20	1/2	325x265	200	11,8



art.	GN	dim. mm.	h. mm.	lt.
14567-06	1/3	325x180	65	2,4
14567-10	1/3	325x180	100	3,6
14567-15	1/3	325x180	150	5,3
14567-20	1/3	325x180	200	7,0



art.	GN	dim. mm.	h. mm.	lt.
14568-06	1/4	265x160	65	1,7
14568-10	1/4	265x160	100	2,5
14568-15	1/4	265x160	150	3,7
14568-20	1/4	265x160	200	5,5



art.	GN	dim. mm.	h. mm.	lt.
14569-06	1/6	176x160	65	1,0
14569-10	1/6	176x160	100	1,5
14569-15	1/6	176x160	150	2,2
14569-20	1/6	176x160	200	3,4



art.	GN	dim. mm.	h. mm.	lt.
14570-06	1/9	176x110	65	0,6
14570-10	1/9	176x110	100	1,0



GN-lid without handle
GN coperchio senza traversino
GN-Deckel ohne Griff
GN couvercle sans poignée
GN tapa sin asa

art.	GN	dim. mm.
14571-00	2/1	650x530



GN-lids with handle
GN coperchi con traversino
GN-Deckel mit Griff
GN couvercles avec poignée
GN tapas con asa

art.	GN	dim. mm.
14572-00	1/1	530x325
14575-00	1/2	325x265
14577-00	1/3	325x180
14578-00	1/4	265x160
14579-00	1/6	176x160
14580-00	1/9	176x110

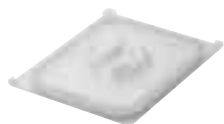

GN-lid with silicone seal
GN coperchio con guarnizione silicone
GN-Deckel mit Silikondichtung
GN couvercle avec joint silicone
GN tapa con junta de silicona

art.	GN	dim. mm.
14585-00	1/2	325x265



Drainer plate
Falso fondo forato
Abtropfplatte
Plateau double fond perforé
Fondo perforado

art.	GN	dim. mm.
14591-00	2/1	650x530
14592-00	1/1	530x325
14595-00	1/2	325x265
14597-00	1/3	325x180
14598-00	1/4	265x160
14599-00	1/6	176x160

TRITAN BPA FREE

GN FOOD PANS
CONTENITORI GN



TRITAN - COPOLYMER - BPA FREE -40°C+90°C.

Can be used in microwave ovens but not for prolonged times. The lids of the series 14800 polycarbonate and 14600 Tritan are interchangeable.

Hermetic lids, NOT water-tight.

TRITAN COPOLIMERO - BPA FREE -40°C+90°C.

Utilizzabili nel microonde ma non per tempi prolungati. I coperchi della serie 14800 policarbonato e 14600 Tritan sono intercambiabili.

Coperchi ermetici, NON a tenuta stagna.

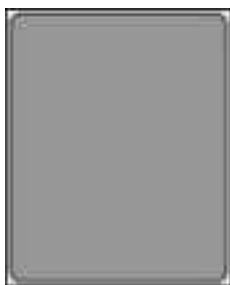

GN-containers

GN bacinelle
GN-Behälter
GN bacs
GN cubetas

art.	GN	dim. mm.	h. mm.	lt.
14661-20	2/1	650x530	200	55,5



art.	GN	dim. mm.	h. mm.	lt.
14662-06	1/1	530x325	65	9,0
14662-10	1/1	530x325	100	13,3
14662-15	1/1	530x325	150	20,0
14662-20	1/1	530x325	200	26,4



art.	GN	dim. mm.	h. mm.	lt.
14665-06	1/2	325x265	65	4,0
14665-10	1/2	325x265	100	6,1
14665-15	1/2	325x265	150	9,0
14665-20	1/2	325x265	200	11,9

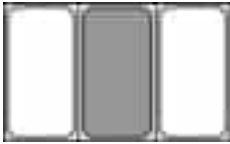

art.	GN	dim. mm.	h. mm.	lt.
14667-06	1/3	325x175	65	2,5
14667-10	1/3	325x175	100	3,8
14667-15	1/3	325x175	150	5,5
14667-20	1/3	325x175	200	7,1



art.	GN	dim. mm.	h. mm.	lt.
14668-06	1/4	264x162	65	1,7
14668-10	1/4	264x162	100	2,6
14668-15	1/4	264x162	150	3,8
14668-20	1/4	264x162	200	4,8



art.	GN	dim. mm.	h. mm.	lt.
14669-06	1/6	176x162	65	1,0
14669-10	1/6	176x162	100	1,6
14669-15	1/6	176x162	150	2,3
14669-20	1/6	176x162	200	2,8



art.	GN	dim. mm.	h. mm.	lt.
14670-06	1/9	176x108	65	0,6
14670-10	1/9	176x108	100	0,9



GN-lids
GN-coperchi
GN-Deckel
GN couvercles
GN tapas

art.	GN	dim. mm.
14671-00	2/1	650x530
14672-00	1/1	530x325
14675-00	1/2	325x265
14677-00	1/3	325x175
14678-00	1/4	264x162
14679-00	1/6	176x162
14680-00	1/9	176x108



GN-lids, hermetic
GN coperchi ermetici
GN-Deckel, hermetisch
GN couvercles hermétiques
GN tapas herméticas

art.	GN	dim. mm.
14682-00	1/1	530x325
14685-00	1/2	325x265
14687-00	1/3	325x175
14688-00	1/4	264x162
14689-00	1/6	176x162
14690-00	1/9	176x108



Drainer plate
Falso fondo forato
Abtropfplatte
Plateau double fond perforé
Fondo perforado

art.	GN	dim. mm.
14691-00	2/1	650x530
14692-00	1/1	530x325
14695-00	1/2	325x265

POLYPROPYLENE POLIPROPILENE

GN FOOD PANS
CONTENITORI GN



Transparent and stackable. Dish-washer safe. Do not use abrasive sponges and substances. Recommended for use from -40°C to $+70^{\circ}\text{C}$. Graduation scale in liters. Lids tightly fitting.

Traslucide e impilabili. Lavabili in lavastoviglie con normali detersivi. Non utilizzare pagliette e sostanze abrasive. Consigliato l'utilizzo da -40°C a $+70^{\circ}\text{C}$. Scala di graduazione in litri. Coperchio resistente per una perfetta chiusura stagna.



GN-containers

GN bacinelle
GN-Behälter
GN bacs
GN cubetas

art.	GN	dim. mm.	h. mm.	lt.
14702-06	1/1	530x325	65	8,5
14702-10	1/1	530x325	100	13,0
14702-15	1/1	530x325	150	19,5
14702-20	1/1	530x325	200	26,0



art.	GN	dim. mm.	h. mm.	lt.
14705-06	1/2	325x265	65	3,9
14705-10	1/2	325x265	100	5,9
14705-15	1/2	325x265	150	8,9
14705-20	1/2	325x265	200	11,8



art.	GN	dim. mm.	h. mm.	lt.
14707-06	1/3	325x180	65	2,4
14707-10	1/3	325x180	100	3,6
14707-15	1/3	325x180	150	5,3
14707-20	1/3	325x180	200	7,0



art.	GN	dim. mm.	h. mm.	lt.
14708-06	1/4	265x160	65	1,7
14708-10	1/4	265x160	100	2,5
14708-15	1/4	265x160	150	3,7
14708-20	1/4	265x160	200	5,5



art.	GN	dim. mm.	h. mm.	lt.
14709-06	1/6	176x160	65	1,0
14709-10	1/6	176x160	100	1,5
14709-15	1/6	176x160	150	2,2
14709-20	1/6	176x160	200	3,4



art.	GN	dim. mm.	h. mm.	lt.
14710-06	1/9	176x110	65	1,3
14710-10	1/9	176x110	100	0,8



Drainer plate

Falso fondo forato
Abtropfplatte
Plateau double fond perforé
Fondo perforado

art.	GN	dim. mm.	h. mm.
14712-00	1/1	471x266	16
14715-00	1/2	266x206	16
14717-00	1/3	266x117	16
14718-00	1/4	207x103	16
14719-00	1/6	117x103	16



GN-lids
GN-coperchi
GN-Deckel
GN couvercles
GN tapas

art.	GN	dim. mm.	col.
14722-00	1/1	530x325	●
14722-11	1/1	530x325	●
14722-22	1/1	530x325	●
14722-33	1/1	530x325	●
14722-99	1/1	530x325	○



art.	GN	dim. mm.	col.
14725-00	1/2	325x265	●
14725-11	1/2	325x265	●
14725-22	1/2	325x265	●
14725-33	1/2	325x265	●
14725-99	1/2	325x265	○



art.	GN	dim. mm.	col.
14727-00	1/3	325x180	●
14727-11	1/3	325x180	●
14727-22	1/3	325x180	●
14727-33	1/3	325x180	●
14727-99	1/3	325x180	○



art.	GN	dim. mm.	col.
14728-00	1/4	265x160	●
14728-11	1/4	265x160	●
14728-22	1/4	265x160	●
14728-33	1/4	265x160	●
14728-99	1/4	265x160	○



art.	GN	dim. mm.	col.
14729-00	1/6	176x160	●
14729-11	1/6	176x160	●
14729-22	1/6	176x160	●
14729-33	1/6	176x160	●
14729-99	1/6	176x160	○



art.	GN	dim. mm.	col.
14730-00	1/9	176x110	●
14730-11	1/9	176x110	●
14730-22	1/9	176x110	●
14730-33	1/9	176x110	●
14730-99	1/9	176x110	○

IML POLYPROPYLENE POLIPROPILENE IML

GN FOOD PANS
CONTENITORI GN



With permanent in molded label. To write on the label there is a specific marker that can be removed by simply washing in the dishwasher. Withstand temperatures from -40°C to $+80^{\circ}\text{C}$. With both metric and American graduated scale. **WARNING:** polypropylene containers are not suitable for use on steam tables.

Con etichetta permanente costampata. Per scrivere sull'etichetta è disponibile un pennarello specifico che viene rimosso con il semplice lavaggio in lavastoviglie. Termoresistenti da -40°C a $+80^{\circ}\text{C}$. Scala graduata sia secondo sistema metrico che americano. **AVVERTENZE:** i contenitori in polipropilene non sono indicati per l'uso su tavole a vapore.



GN-containers

GN bacinelle
GN-Behälter
GN bacs
GN cubetas

art.	GN	dim. mm.	h. mm.	lt.
15101-06	1/1	530x325	65	9,0
15101-10	1/1	530x325	100	13,3
15101-15	1/1	530x325	150	20,0
15101-20	1/1	530x325	200	26,4



art.	GN	dim. mm.	h. mm.	lt.
15105-06	1/2	325x265	65	4,0
15105-10	1/2	325x265	100	6,1
15105-15	1/2	325x265	150	9,0
15105-20	1/2	325x265	200	11,9



art.	GN	dim. mm.	h. mm.	lt.
15107-06	1/3	325x175	65	2,5
15107-10	1/3	325x175	100	3,8
15107-15	1/3	325x175	150	5,5
15107-20	1/3	325x175	200	7,1



art.	GN	dim. mm.	h. mm.	lt.
15108-06	1/4	264x162	65	1,7
15108-10	1/4	264x162	100	2,6
15108-15	1/4	264x162	150	3,8
15108-20	1/4	264x162	200	4,8



art.	GN	dim. mm.	h. mm.	lt.
15109-06	1/6	176x162	65	1,0
15109-10	1/6	176x162	100	1,6
15109-15	1/6	176x162	150	2,3
15109-20	1/6	176x162	200	2,8



art.	GN	dim. mm.	h. mm.	lt.
15110-06	1/9	176x108	65	0,6
15110-10	1/9	176x108	100	0,9



Drainer plate

Falso fondo forato
Abtropfplatte
Plateau double fond perforé
Fondo perforado

art.	GN	dim. mm.
14912-00	1/1	530x325
14915-00	1/2	325x265



GN hermetic lids with overmolded GASKET

Coperchi GN ermetici con GUARNIZIONE sovrastampata
GN hermetische Deckel mit umspritze DICHUNG
Couvercles GN hermétiques avec JOINT surmoulé
Tapas GN herméticas con JUNTA sobremoldeada

art.	GN	dim. mm.
14942-99	1/1	530x325
14945-99	1/2	325x265
14947-99	1/3	325x175

GN-lids

GN coperchi
GN-Deckel
GN couvercles
GN tapas



art.	GN	dim. mm.	col.
14922-00	1/1	530x325	●
14922-11	1/1	530x325	●
14922-22	1/1	530x325	●
14922-33	1/1	530x325	●
14922-77	1/1	530x325	●
14922-99	1/1	530x325	○



art.	GN	dim. mm.	col.
14925-00	1/2	325x265	●
14925-11	1/2	325x265	●
14925-22	1/2	325x265	●
14925-33	1/2	325x265	●
14925-77	1/2	325x265	●
14925-99	1/2	325x265	○



art.	GN	dim. mm.	col.
14927-00	1/3	325x175	●
14927-11	1/3	325x175	●
14927-22	1/3	325x175	●
14927-33	1/3	325x175	●
14927-77	1/3	325x175	●
14927-99	1/3	325x175	○



art.	GN	dim. mm.	col.
14928-00	1/4	264x162	●
14928-11	1/4	264x162	●
14928-22	1/4	264x162	●
14928-33	1/4	264x162	●
14928-77	1/4	264x162	●
14928-99	1/4	264x162	○



art.	GN	dim. mm.	col.
14929-00	1/6	176x162	●
14929-11	1/6	176x162	●
14929-22	1/6	176x162	●
14929-33	1/6	176x162	●
14929-77	1/6	176x162	●
14929-99	1/6	176x162	○



art.	GN	dim. mm.	col.
14930-00	1/9	176x108	●
14930-11	1/9	176x108	●
14930-22	1/9	176x108	●
14930-33	1/9	176x108	●
14930-77	1/9	176x108	●
14930-99	1/9	176x108	○



Clips for lids
Clips per coperchi
Clips für Deckel
Clips pour couvercles
Clips para tapas

art.	U. Pack	col.
15100-01	12	●
15100-02	12	●
15100-03	12	●
15100-04	12	●
15100-07	12	●

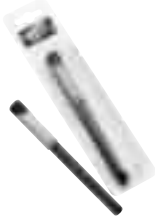

Kit 2 markers
Set 2 pennarelli
Satz 2 Marker
Set 2 marqueurs
Juego 2 marcadores

art.
15100-AA





Melamine is suitable for hot and cold food use. Melamine is suitable for food storage at ambient or chilled temperatures for up to 24 hours. Melamine is not suitable for hot counters, displays, or heated cabinets. Do not expose melamine to direct flame or heat, including heat lamps and plate warmers. Temperature rating is between -20°C and 70°C (-4°F +158°F).

La melamina è adatta per l'uso sia con cibi caldi che freddi. La melamina è adatta per la conservazione degli alimenti a temperatura ambiente o refrigerata fino a 24 ore. La melamina non è adatta per piani caldi, espositori o armadi riscaldati. Non esporre a calore e fiamme dirette, incluse lampade alogene e scaldapiatti. Non esporre gli oggetti in melamina a temperature superiori a 70°C (-20°C +70°C).

GN-containers / Bacinelle / Behälter / Bacs / Cubetas



art.	GN	dim. mm.	h. mm.	lt.	col.
44877-11	1/1	530X325	65	7,1	○
44877B11	1/1	530X325	100	10,6	○
44878-11	1/1	530X325	65	7,1	●
44878B11	1/1	530X325	100	10,6	●



art.	GN	dim. mm.	h. mm.	lt.	col.
44877-24	2/4	160x530	65	3,0	○
44877B24	2/4	160x530	100	4,3	○
44878-24	2/4	160x530	65	3,0	●
44878B24	2/4	160x530	100	4,3	●



art.	GN	dim. mm.	h. mm.	lt.	col.
44877-12	1/2	325X265	65	3,4	○
44877B12	1/2	325X265	100	4,7	○
44878-12	1/2	325X265	65	3,4	●
44878B12	1/2	325X265	100	4,7	●



art.	GN	dim. mm.	h. mm.	lt.	col.
44877-13	1/3	325X175	65	2,0	○
44877B13	1/3	325X175	100	2,7	○
44878-13	1/3	325X175	65	2,0	●
44878B13	1/3	325X175	100	2,7	●



art.	GN	dim. mm.	h. mm.	lt.	col.
44877-14	1/4	265X160	65	1,4	○
44877B14	1/4	265X160	100	1,9	○
44878-14	1/4	265X160	65	1,4	●
44878B14	1/4	265X160	100	1,9	●



art.	GN	dim. mm.	h. mm.	lt.	col.
44877-16	1/6	175X160	65	0,8	○
44877B16	1/6	175X160	100	1,0	○
44878-16	1/6	175X160	65	0,8	●
44878B16	1/6	175X160	100	1,0	●



GN-lids, POLICARBONATE
GN-coperchi, POLICARBONATO
GN-Deckel, POLIKARBONAT
GN couvercles, POLICARBONATE
GN tapas, POLICARBONATO

PC

art.	GN	dim. mm.
44818-11	1/1	530X325
44818-12	1/2	325X265
44818-13	1/3	325X175
44818-14	1/4	265X160
44818-16	1/6	175X160



Buffet ladder, chrome plated
Espositore buffet, cromato
Büffet-Leiter, verchromt
Escalier à buffet, chromé
Escalera para buffet, cromada

GN

art.	GN	dim. mm.
41403-01	1/3	31,5x32x48
41403-02	1/2	31,5x41,5x48
41403-03	1/2	31,5x56x66
41403-04	1/1	52x59x66

PORCELAIN PORCELLANA

GN FOOD PANS
CONTENITORI GN



GN-containers

GN bacinelle

GN-Behälter

GN bacs

GN cubetas

art.	GN	dim. mm.	h. mm.	col.
44332-03	1/1	530x325	20	○
44332-06	1/1	530x325	65	○
44333-03	2/3	353x320	20	○
44333-06	2/3	353x320	65	○
44334-03	2/4	162x530	20	○
44334-06	2/4	162x530	65	○
44335-03	1/2	325x265	20	○
44335-06	1/2	325x265	65	○
44337-03	1/3	325x175	20	○
44337-06	1/3	325x175	65	○
44338-03	1/4	265x160	20	○
44338-06	1/4	265x160	65	○
44339-03	1/6	176x160	20	○
44339-06	1/6	176x160	65	○



art.	GN	dim. mm.	h. mm.	col.
44332B06	1/1	530x325	65	●
44333B06	2/3	353x320	65	●
44335B06	1/2	325x265	65	●
44337B06	1/3	325x175	65	●



art.	GN	dim. mm.	h. mm.	col.
44382A06	1/1	530x325	65	●
44384A06	2/4	162x530	65	●
44385A06	1/2	325x265	65	●
44387A06	1/3	325x175	65	●



art.	GN	dim. mm.	h. mm.	col.
44382B06	1/1	530x325	65	●
44385B06	1/2	325x265	65	●
44387B06	1/3	325x175	65	●



art.	GN	dim. mm.	h. mm.	col.
44382G06	1/1	530x325	65	●
44385G06	1/2	325x265	65	●
44387G06	1/3	325x175	65	●



art.	GN	dim. mm.	h. mm.	col.
44382O06	1/1	530x325	65	●
44383O06	2/3	353x320	65	●
44384O06	2/4	162x530	65	●
44385O06	1/2	325x265	65	●
44387O06	1/3	325x175	65	●



art.	GN	dim. mm.	h. mm.	col.
44382Y06	1/1	530x325	65	●
44383Y06	2/3	353x320	65	●
44384Y06	2/4	162x530	65	●
44385Y06	1/2	325x265	65	●
44387Y06	1/3	325x175	65	●



art.	GN	dim. mm.	h. mm.	col.
44384R06	2/4	162x530	65	●
44385R06	1/2	325x265	65	●
44387R06	1/3	325x175	65	●

INDUCTION PORCELAIN PORCELLANA INDUZIONE

GN FOOD PANS
CONTENITORI GN



INDUCTION
READY!





GN-containers

GN bacinelle

GN-Behälter

GN bacs

GN cubetas

art.	GN	dim. mm.	h. mm.	col.
44342-06	1/1	530x325	65	○
44343-06	2/3	353x320	65	○
44344-06	2/4	162x530	65	○
44345-06	1/2	325x265	65	○
44347-06	1/3	325x175	65	○
44346-06	1/4	265x160	65	○



art.	GN	dim. mm.	h. mm.	col.
44312A06	1/1	530x325	65	●
44314A06	2/4	162x530	65	●
44315A06	1/2	325x265	65	●
44317A06	1/3	325x175	65	●



art.	GN	dim. mm.	h. mm.	col.
44312B06	1/1	530x325	65	●
44313B06	2/3	353x320	65	●
44314B06	2/4	162x530	65	●
44315B06	1/2	325x265	65	●
44317B06	1/3	325x175	65	●



art.	GN	dim. mm.	h. mm.	col.
44312G06	1/1	530x325	65	●
44313G06	2/3	353x320	65	●
44314G06	2/4	162x530	65	●
44315G06	1/2	325x265	65	●
44317G06	1/3	325x175	65	●



art.	GN	dim. mm.	h. mm.	col.
44312O06	1/1	530x325	65	●
44313O06	2/3	353x320	65	●
44314O06	2/4	162x530	65	●
44315O06	1/2	325x265	65	●
44317O06	1/3	325x175	65	●



art.	GN	dim. mm.	h. mm.	col.
44312R06	1/1	530x325	65	●
44313R06	2/3	353x320	65	●
44314R06	2/4	162x530	65	●
44315R06	1/2	325x265	65	●
44317R06	1/3	325x175	65	●



art.	GN	dim. mm.	h. mm.	col.
44312Y06	1/1	530x325	65	●
44313Y06	2/3	353x320	65	●
44314Y06	2/4	162x530	65	●
44315Y06	1/2	325x265	65	●
44317Y06	1/3	325x175	65	●

SERIES 12900

KITCHEN UTENSILS
UTENSILI DA CUCINA

PA+
plus



A wide range of professional kitchen utensils in composite material, polyamide (nylon 6.6) with fiberglass. Dishwasher safe, can be sterilized, heat resistant up to 220°C. Safe for non-stick cookware.

Un'ampia gamma di utensili professionali per la cucina in materiale composito, poliammide (nylon 6.6) con fibra di vetro. Lavabili in lavastoviglie, sterilizzabili, resistenti fino a 220°C. Ideali per l'uso con antiaderenti.



PA+
plus

Spoon
Cucchiaione
Löffel
Mouvette
Cuchara

art.	l. cm.
12903-30	30
12903-40	38
12903-45	45



PA+
plus

Spatula
Spatola
Teigschäber
Spatule
Espátula

art.	l. cm.
12905-25	25
12905-30	30
12905-35	35
12905-40	40
12905-45	45
12905-50	50



PA+
plus

Stirring ladle
Spatola per stemperare
Rühr-u. Temperierlöffel
Spatule à délayer
Espátula para diluir

art.	l. cm.
12907-07	35
12907-08	35



PA+
plus

Spatula
Spatola
Stielschäber
Spatule
Espátula

art.	l. cm.
12915-25	25
12915-26	28
12915-35	35
12915-45	45



PA+
plus

Spatula
Spatola
Teigschäber
Spatule
Espátula

art.	l. cm.
12916-25	25
12916-33	33



PA+
plus

Bevelled spatula
Spatola smussata
Teigschäber
Spatule plate biseautée
Espátula blanda

art.	l. cm.
12906-35	35



PA+
plus

Spatula
Spatola
Teigschäber
Spatule
Espátula

art.	l. cm.
12908-30	30
12908-35	35
12908-40	40



PA+
plus

Angular spatula
Paletta angolare
Winkelpalette
Spatule angulaire
Espátula

art.	l. cm.
12909-12	12
12909-23	23



PA+
plus

Spatula, perforated
Paletta forata
Teigschäber, perforiert
Spatule ajourée
Espátula perforada

art.	l. cm.
12921-01	30



PA+
plus

Spatula, perforated
Paletta forata
Teigschäber, perforiert
Spatule ajourée
Espátula perforada

art.	l. cm.
12921-05	30



PA+
plus

Spatula
Paletta
Teigschäber
Spatule
Espátula

art.	l. cm.
12921-10	32



PA+
plus

Fish & chips spatula
Paletta fritti
Fischheber
Pelle à friture
Espátula fritura

art.	l. cm.
12921-15	35



PA+
plus

Ladle
Mestolo
Schöpflöffel
Louche
Cacillo

art.	Ø cm.	l. cm.
12920-01	9	31



PA+
plus

Skimmer
Schiumarola
Schaumlöffel
Ecumoire
Espumadera

art.	Ø cm.	l. cm.
12920-05	11	35



PA+
plus

Spatula
Paletta
Teigschäber
Spatule
Espátula

art.	cm.	l. cm.
12920-10	9x10	35



PA+
plus

Fish & chips spatula
Paletta fritti
Fischheber
Pelle à friture
Espátula fritura

art.	cm.	l. cm.
12920-11	9x10	35



PA+
plus

Spoon
Cucchiaione
Giesslöffel
Cuillère
Cucharón

art.	l. cm.
12920-15	35



PA+
plus

Perforated spoon
Cucchiaione forato
Giesslöffel, perforiert
Cuillère perforée
Cucharón perforado

art.	l. cm.
12920-16	35



PA+
plus

Salad tongs
Molla insalata
Salatzange
Pince à salade
Pinza ensalada

art.	l. cm.
12930-51	25
12930-52	32



PA+
plus

Bread and pastry tongs
Molla per pane e pasticceria
Brot-/Gebäckzange
Pince à pain et pâtisserie
Pinza para pan y pasteleria

art.	l. cm.
12930-62	18
12930-63	23



PA+
plus

Serving tongs
Molla tutto servire
Servierzange
Pince à servir
Pinza servir

art.	l. cm.
12930-68	20
12930-69	25



PA+
plus

Spaghetti tongs
Molla spaghetti
Spaghettizange
Pince à spaghetti
Pinza espagueti

art.	l. cm.
12930-74	24



PA+
plus

Toast and pastry tongs
Molla per toast e dolci
Toast-/Gebäckzange
Pince à toast et tarte
Pinza para tostadas y dulces

art.	l. cm.
12930-77	21
12930-78	25



PA+
plus

Meat ball plier
Forbice per polpette
Fleischkugelzange
Pince à boulettes
Pinza albóndigas

art.	l. cm.
12931-51	17



PA+
plus

Quenelle plier
Forbice per chenelle
Quenellezange
Pince à quenelles
Pinza quenelles

art.	l. cm.
12931-53	19



PA+
plus

Perforated ladle
Mestolo forato
Schöpflöffel, gelocht
Louche perforée
Cacillo perforado

art.	Ø cm.	l. cm.
12967-06	6,5	30
12967-10	10,0	37,5



PA+
plus

Ladle
Mestolo
Schöpflöffel
Louche
Cacillo

art.	Ø cm.	l. cm.
12970-06*	6,5	30,0
12970-08	8,0	33,5
12970-10	10,0	37,5
12970-12	12,0	40,0

*With spout. – Con becco.



PA+
plus

Pizza ladle, flat bottom
Mestolo pizza, fondo piatto
Schöpflöffel
Louche
Cacillo

art.	Ø cm.	l. cm.
12968-10	10	27



PA+
plus

Ladle, short handle
Mestolo, manico corto
Schöpflöffel mit kurzen Stiel
Louche, manche court
Cacillo, mango corto

art.	Ø cm.	l. cm.
12969-10	10	27



PA+
plus

Ladle, short handle
Mestolo, manico corto
Schöpflöffel mit kurzen Stiel
Louche, manche court
Cacillo, mango corto

art.	Ø cm.	l. cm.
12969-06	6,5	24



PA+
plus

Spoon
Cucchiaione
Löffel
Cuillère
Cuchara

art.	l. cm.
12986-38	37,5



PA+
plus

Spoon, short handle
Cucchiaione, manico corto
Löffel mit kurzen Stiel
Cuillère, manche court
Cuchara, mango corto

art.	l. cm.
12986-01	23



PA+
plus

Skimmer
Schiumarola
Schaumlöffel
Ecumoire
Espumadera

art.	Ø cm.	l. cm.
12971-10	10	31
12971-12	12	37



PA+
plus

Spatula
Paletta liscia
Backschaufel
Spatule
Espátula lisa

art.	cm.	l. cm.
12972-10	10	36,5
12972-12	12	38,0



PA+
plus

Perforated spatula
Paletta forata
Backschaufel, perforiert
Spatule perforée
Espátula perforada

art.	cm.	l. cm.
12973-10	10	36,5
12973-12	12	38



SS
PA+
plus

Wire whip, 8 silicone wires
Frusta, 8 fili silicone
Rührbesen, 8 Drähte aus Silikon
Fouet, 8 fils en silicone
Batidor, 8 varillas de siliconea

art.	l. cm.
12926-35	35



SS
PA+
plus

Wire whip, 8 wires
Frusta, 8 fili
Rührbesen, 8 Drähte
Fouet, 8 fils
Batidor, 8 varillas

art.	l. cm.
12928-25	25
12928-30	30
12928-35	35
12928-40	40
12928-45	45
12928-50	50
12928-55	55
12928-60	60



SS
PA+
plus

Egg whisk, 11 wires
Frusta media, 11 fili
Schneebesen, 11 Drähte
Fouet, 11 fils
Batidor, 11 varillas

art.	l. cm.
12929-25	25
12929-30	30
12929-35	35
12929-40	40
12929-45	45

Water-tight, dishwasher safe.
Perfetta tenuta stagna, lavabile in lavastoviglie.

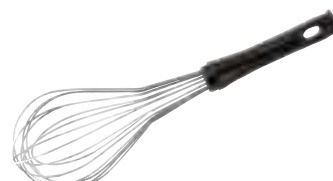

SS
PA+
plus

Balloon whisk
Frusta balloon
Schneebesen
Fouet à blancs
Batidor tipo globo

art.	l. cm.
12927-35	35
12927-45	45

Water-tight, dishwasher safe.
Perfetta tenuta stagna, lavabile in lavastoviglie.

SERIES 48280 - 48278

KITCHEN UTENSILS
UTENSILI DA CUCINA



A wide range of professional kitchen utensils. These are essential tools to make original decorations as well as to ease the preparation of your recipes. All items are made of 18/10 stainless steel while their ergonomic handles are available both in stainless steel and Polypropylene. They are all hangable and can be cleaned in dishwasher. They boast a modern, functional design and are very easy to use.

Un'ampia gamma di utensili professionali per la cucina, indispensabili per creare decorazioni originali e fantasiose, ma utili anche per svolgere le più semplici operazioni in modo preciso e veloce. Tutti i pezzi sono realizzati in acciaio inox 18/10, mentre la manicatura ergonomica è prevista nella versione acciaio inox o polipropilene. Tutti gli articoli sono dotati di un foro sul manico per essere appesi. Lavabili in lavastoviglie. Il design è moderno e funzionale per il massimo comfort d'utilizzo.



Pizza chef knife

Coltello pizzaiolo
Messer für Pizzakoch
Couteau à chef de pizza
Cuchillo para chef de pizza

art.	l. cm.
48280-45	23,5



Pizza wheel

Rotella tagliapizza
Pizzaschneider
Roulette à pizza
Ruedecilla cortapizzas

art.	Ø cm.	l. cm.
18324-10	10	24



Pastry wheel

Rotella tagliapasta
Teigrädchen
Roulette à pâte
Ruedecilla para pasta

art.	Ø cm.	l. cm.
48280-32	4	18



Double pastry wheel

Rotella tagliapasta doppia
Doppel-Teigrädchen
Roulette a pâte double
Ruedecilla para pasta doble

art.	Ø cm.	l. cm.
48280-39	4	18



Vegetable knife

Coltello verdure
Gemüsemesser
Couteau à légumes
Cuchillo para verduras

art.	l. cm.
48280-48	19



One-hand mincing knife

Falcetta prezzemolo
Einhandwiegemesser
Hachinette persil
Cuchillo para perejil

art.	Ø cm.	l. cm.
48280-20	11	17



Parmesan cheese knife

Coltello grana
Parmesanmesser
Couteau à Parmesan
Cuchillo queso parmenso

art.	l. cm.
48280-04	20



Oyster knife

Coltello apriostriche
Austernmesser
Couteau à huîtres
Cuchillo ostras

art.	l. cm.
48280-05	20,5



Chestnut knife

Coltello castagne
Kastanienmesser
Couteau à châtaignes
Cuchillo castañas

art.	l. cm.
48280-21	16



Fish scaler

Squamapesce
Fischentschupper
Ecailleur
Raspador de escamas

art.	l. cm.
48280-38	23,5



Double fish scaler

Squamapesce doppio
Fischentschupper
Ecailleur double
Raspador de escamas doble

art. cm.
48280-37 22,5x3,5



Cheese cleaver

Mannaietta per formaggio
Käsemesser
Couperet à fromage
Hachita para queso

art. cm.
48280-49 21x4



Parmesan cheese knife

Coltello parmigiano
Parmesankäsemesser
Couteau à Parmesan
Cuchillo para queso parmesano

art. l. cm.
48280-46 24



Vegetable sharpener

Temperino per verdure
Spiralschneider
Taille crayon légumes
Afilador para vegetales

art. Ø cm.
48280-12 4,5
48280-13 7,0



Basting brush

Pennello
Backpinsel
Pinceau
Pincel pastelería

art. cm.
48280-94 22,5x3,5

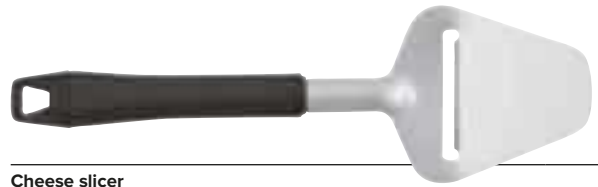

Cheese slicer

Affetta formaggio
Käsehobel
Coupe-fromage
Cortador de queso

art. cm.
48280-41 25x7,6



Cheese knife

Coltello formaggio
Käsemesser
Couteau à fromage
Cuchillo para queso

art. l. cm.
48280-59 27



Butter spreader

Spalmburro
Butterstreicher
Tartineur
Cuchillo mantequilla

art. l. cm.
48280-75 21,5



Silicone basting brush

Pennello in silicone
Backpinsel, Silikon
Pinceau, silicone
Pincel pastelería, silicona

art. cm.
48280-09 25,5x4



Cheese grater

Grattugia formaggio
Käseraffel
Râpe à fromage
Rallador de queso

art. l. cm.
48280-06 24



Bottle opener

Levacapsule
Flaschenöffner
Décapsuleur
Abrebotellas

art.	l. cm.
48280-02	19



Can opener

Apriscatole
Flügel Dosenöffner
Ouvre-boîtes
Abrelatas

art.	cm.
48280-03	22x4,6



Melon baller

Scavino
Kugelausstecher
Moule à pomme
Vaciador

art.	Ø cm.	l. cm.
48280-24	1,0	19,0
48280-30	1,5	19,0
48280-31	2,0	19,0
48280-35	2,3	19,5
48280-36	3,0	19,5



Double melon baller

Scavino doppio
Kugelausstecher, doppel
Moule à pomme, double
Vaciador doble

art.	Ø cm.	l. cm.
48286-67	2,2-3,0	17



Oval melon baller

Scavino ovale
Kugelausstecher, oval
Moule à pomme, ovale
Vciador oval

art.	Ø cm.	l. cm.
48280-26	1,9	19,5



Zucchini corer, dented

Svuota zucchini
Zucchini-Entkerner
Vide-courgettes
Vaciador de zucchini

art.	l. cm.
48280-54	24,5



Pineapple coring tool

Svuota ananas
Ananasausstecher
Vide-ananas
Descorazonador de piña

art.	l. cm.
48280-10	25



Asparagus peeler

Pela asparagi
Spargelschäler
Éplucheur à asperges
Pelador de espárragos

art.	l. cm.
48280-85	23,5



Tomato peeler

Pela pomodori
Tomatenschäler
Éplucheur à tomates
Pelador de tomates

art.	l. cm.
48280-08	18



Y-shaped swivel peeler

Sbucciatore a lama mobile
Pendelschäler
Éplucheur à lame pivotante
Pelador oscilante

art.	l. cm.
48280-53	18,5
48280-52	21,0



Melon peeler

Sbuccia melone
Melonenschäler
Éplucheur à melon
Pelador de melon

art.	Ø cm.	l. cm.
48280-60	8,0	20
48280-61	9,0	21
48280-62	10,5	22
48280-63	12,0	23



Potato peeler

Pelapatate
Kartoffelschäler
Éplucheur
Pelador de patatas

art.	l. cm.
48280-34	19,5



Orange peeler

Pelorange
Orangenschäler
Éplucheur à orange
Pelador de naranjas

art.	l. cm.
48280-96	20



Grapefruit knife

Coltello per pompelmo
Grapefruitmesser
Couteau à pamplemousse
Cuchillo para pomelo

art.	l. cm.
48280-47	21,5



Citrus bar knife

Coltello bar
Bar Messer
Couteau bar
Cuchillo bar

art.	l. cm.
48280-97	23



Fruit scoop

Cucchiaio scavino frutta
Fruchtöffel
Cuillère à évider pour fruits
Cuchara ahueca frutas

art.	l. cm.
48280-15	20



Butter curler

Arricciaburro
Butterroller
Coquilleur à beurre
Rizador de mantequilla

art.	l. cm.
48280-11	22,5



Fruit decorator knife

Coltello decora frutta
Fruchtdekoriermesser
Couteau denteleur
Cuchillo para decorar fruta

art.	l. cm.
48280-91	23



Citrus stripper

Decoratore
Ziseliermesser
Canneleur

Rallador de cítricos

art. l. cm.
48280-95 16,5



Citrus zester stripper

Rigalimoni decoratore
Zester Ziseliermesser
Zesteur canneleur

Acanalador rallador cítricos

art. l. cm.
48280-92 17



Citrus zester

Rigalimoni
Zester
Zesteur

Acanalador de cítricos

art. l. cm.
48280-90 17



Apple corer

Levatorsoli
Entkerner
Vide-pomme

Descorazonador

art. Ø cm. l. cm.
48280-25 1,2 21



Wavy vegetable cutter

Tagliaverdure ondulato
Wellenschneider
Coupe-légumes ondulé

Cortador de verduras ondulado

art. l. cm.
48280-23 11,5



Coil whisk

Frusta a spirale
Spiral Schneebesen
Fouet à spirale

Batidor espiral

art. Ø cm. l. cm.
48278-24 5 26,5

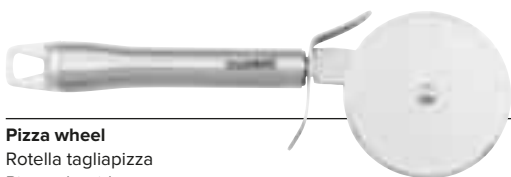

Pizza wheel

Rotella tagliapizza
Pizzaschneider
Roulette à pizza

Ruedecilla pizza

art. Ø cm. l. cm.
48278-33 7 21



Pastry wheel

Rotella tagliapasta
Teigrädchen
Roulette à pâte

Ruedecilla para pasta

art. Ø cm. l. cm.
48278-32 4 18

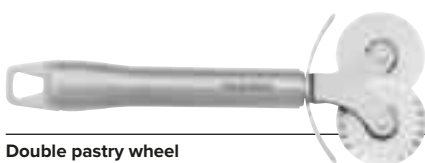

Double pastry wheel

Rotella tagliapasta doppia
Doppel-Teigrädchen
Roulette a pâte double

Ruedecilla para pasta doble

art. Ø cm. l. cm.
48278-39 4 18



Fish scaler

Squamapesce
Fischentschupper
Ecailleur

Quita escamas

art. l. cm.
48278-38 22



Paring knife

Spelucchino
Spickmesser
Couteau d'office
Cuchillo mondador

art.	l. cm.
48278-55	22,5



Conical colander

Colino conico
Spitzsieb
Passoire chinois
Colador cónico

art.	Ø cm.	l. cm.
48278-13	16	35

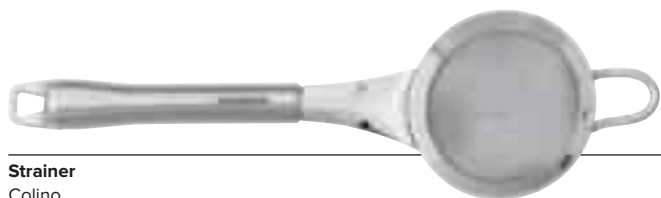

Strainer

Colino
Sieb
Passoire
Colador

art.	Ø cm.	l. cm.
48278-12	8	27



Vegetable knife

Coltello verdure
Gemüsemesser
Couteau à légumes
Cuchillo para verduras

art.	l. cm.
48278-48	19



Soft cheese slicer

Affetta formaggio tenero
Weichkäsehobel
Coupe-fromage à pâte molle
Cortador de queso blando

art.	cm.
48278-42	20x7,5



Cheese cleaver

Mannaietta per formaggio
Käsemesser
Couperet à fromage
Hachita para queso

art.	cm.
48278-49	21x4



Parmesan cheese knife

Coltello parmigiano
Parmesankäsemesser
Coutau à Parmesan
Cuchillo queso parmeso

art.	l. cm.
48278-46	23,5



Cheese slicer

Affetta formaggio
Käsehobel
Coupe-fromage
Cortador de queso

art.	l. cm.
48278-41	25



Potato masher

Pressapatate
Kartoffelstampfer
Presse-purée
Prensador de patatas

art.	cm.	l. cm.
48278-87	8x7	27



Potato masher

Pressapatate
Kartoffelstampfer
Presse-purée
Prensador de patatas

art.	cm.
48278-31	27x8



Butter spreader

Spalmaburro
Butterstreicher
Tartineur
Cuchillo mantequilla

art.	l. cm.
48278-75	21

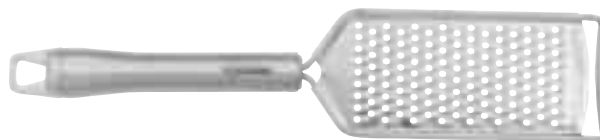

Grater

Grattugia
Raffel
Râpe
Rallador

art.	cm.
48278-20	25,5x5,5

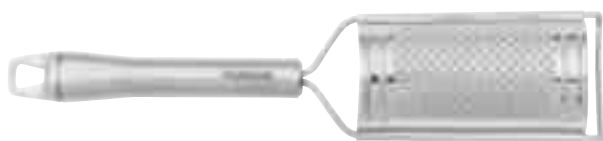

Grater

Grattugia
Raffel
Râpe
Rallador

art.	cm.
48278-21	25,5x5,5



Oyster knife

Coltello apriostriche
Austernmesser
Couteau à huîtres
Cuchillo para ostras

art.	l. cm.
48278-45	20



Straight icing spatula

Spatola per glassa
Glasurpalette
Spatule glaçage plate
Espátula pastelera

art.	l. cm.
48278-77	27,5



Basting brush

Pennello
Backpinsel
Pinceau cuisine
Pincel pastelería

art.	l. cm.
48278-94	22



Garlic press

Spremiaglio
Knoblauchpresse
Presse-ail
Prensador de ajo

art.	cm.
48278-37	19x5

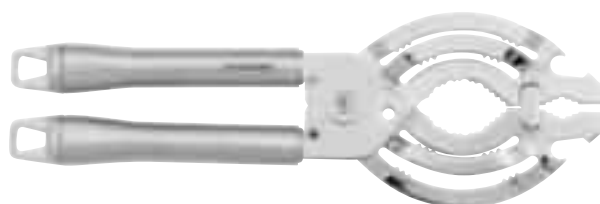

Jar opener

Apribarattoli
Einmachglasöffner
Ouvre-bocal
Abridor de tarros

art.	cm.
48278-01	25,5x8,5



Bottle opener

Levacapsule
Flaschenöffner
Ouvre-bouteille
Abrebotellas

art. cm.
48278-02 19x3,7



Zucchini corer

Svuota zucchine
Zucchini-Entkerner
Vide-courgettes
Vaciador de zucchini

art. l. cm.
48278-54 25



Swivel peeler

Sbucciatore a lama mobile
Pendelschäler
Éplucheur à lame pivotante
Pelador oscilante

art. l. cm.
48278-52 21



Y-shaped swivel peeler

Sbucciatore a Y
Y-Pendelschäler
Éplucheur
Pelador Y

art. l. cm.
48278-53 18,5



Apple corer

Levatoroli
Apfelentkerner
Vide-pomme
Descorazonador de manzana

art. Ø cm. l. cm.
48278-25 1,6 21,5



Potato fork 3 prongs

Forchettina patate 3 punte
Pellkartoffelgabel 3 Zinken
Fourchette à pommes de terre
Tenedor tridente para patatas

art. l. cm.
48278-17 16,5



Can opener

Apriscatole
Flügeldosenöffner
Ouvre-boîte
Abrelatas

art. cm.
48278-03 22x4,6



Potato peeler

Pelapatate
Kartoffelschäler
Éplucheur
Pelador de patatas

art. l. cm.
48278-34 19,5



Melon baller

Scavino
Kugelausstecher
Moule à pomme
Vaciador

art. Ø cm. l. cm.
48278-35 3 18



Orange peeler

Pelarance
Orangenschäler
Éplucheur à orange
Pelador de naranja

art. l. cm.
48278-96 20



Grapefruit knife

Coltello per pompelmo
Grapefruitmesser
Couteau à pamplemousse
Cuchillo para pomelo

art. l. cm.
48278-47 21,5



Ice cream scoop

Porzionatore gelato
Eisportionierer
Cuillère à glace
Porcionador para helado

art. Ø cm. l. cm.
48278-95 4 21



Coffee measuring spoon

Dosacaffè
Kaffeedosierlöffel
Cuillère doaseuse à café
Cuchara dosificador de café

art. Ø cm. l. cm.
48278-16 3,5 20



Egg separator

Separauova
Eiertrenner
Séparateur d'oeuf
Separador de huevos

art. Ø cm. l. cm.
48278-36 5,5 20,5



Fruit decorator knife

Coltello decora frutta
Fruchtdekoriermesser
Couteau denteleur
Cuchillo para decorar frutas

art. l. cm.
48278-91 22,5



Cocktail spoon

Cucchiaio cocktail
Cocktaillöffel
Cuiller à cocktail
Cuchara cóctel

art. Ø cm. l. cm.
48278-15 6 28



Citrus zester stripper

Rigalimoni decoratore
Zester Ziseliermesser
Zesteur canneléur
Acanalador rallador cítricos

art. l. cm.
48278-92 16,5



Butter curler

Arricciaburro
Butterroller
Coquilleur à beurre
Rizador de mantequilla

art. l. cm.
48278-11 21,5



Odor eliminator soap bar

Saponetta togli odori
Geruch Entferner Seife
Savonette enlève odeurs
Jabón quita odores

art. cm.
48278-99 7,5x5,5



Sauce ladle

Mestolino salsa
Saucenlöffel
Louche à sauce
Cacillo salsas

art. Ø cm. l. cm.
48278-68 7 29



Soup ladle

Mestolo
Schöpflöffel
Louche à soupe
Cazo sopa

art. Ø cm. l. cm.
48278-69 9 32
48278-66 6 29



Salad serving fork

Forchetta servire insalata
Salatserviergabel
Fourchette à servir salade
Tenedor servir ensalada

art. Ø cm. l. cm.
48278-64 5 25,5



Salad spoon

Cucchiaio per insalata
Salatlöffel
Cuillère à salade
Cucharón ensalada

art.	Ø cm.	l. cm.
48278-62	5	25



Perforated spoon

Cucchiaio forato
Giesslöffel, perforiert
Cuillère percée
Cuchara perforada

art.	cm.
48278-61	34x6



Slotted turner

Paletta forata
Küchenwender, perforiert
Pelle ajourée
Espátula perforada

art.	cm.
48278-71	34,5x8,5



Skimmer

Schiumarola
Schaumlöffel
Ecumoire
Espumadera

art.	Ø cm.	l. cm.
48278-73	11	37

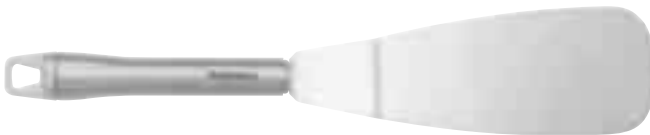

Spatula

Spatola
Spachtel
Spatule
Espátula

art.	cm.
48278-76	28,5x5,6



Cake server

Pala torta
Tortenheber
Pelle à tarte
Pala tarta

art.	cm.
48278-93	26x5,8



Spaghetti server

Servispaghetti
Spaghettilöffel
Cuillère à spaghetti
Servidor para espagueti

art.	Ø cm.	l. cm.
48278-74	7	30,5



Meat fork

Forchettone
Fleischgabel
Fourchette à viande
Tenedor trinchar

art.	l. cm.
48278-65	32,5



Rice spoon

Cucchiaio risotto
Reislöffel
Cuillère de service à riz
Cuchara arroz

art.	l. cm.
48278-63	27



Spatula

Spatola lasagne
Lasagne Spatel
Palette
Espátula lasaña

art.	cm.
48278-27	29x4,5



Skimmer

Schiumarola
Schaumlöffel
Ecumoire
Espumadera

art.	Ø cm.	l. cm.
48278-88	11	36,5



Soup ladle

Mestolo
Schöpflöffel
Louche à soupe
Cazo sopa

art.	Ø cm.	l. cm.
48278-84	9,5	32,5



Rice spoon

Cucchiaio riso
Reislöffel
Cuillère de service à riz
Cuchara arroz

art.	cm.
48278-82	33x6,5



Perforated spoon

Cucchiaio forato
Gießlöffel, perforiert
Cuillère percée
Cuchara perforada

art.	cm.
48278-81	33x6,5



Spaghetti server

Servispaghetti
Spaghettillöffel
Cuillère à spaghetti
Servidor para espagueti

art.	cm.
48278-89	32x6,5



Meat fork

Forchettone
Fleischgabel
Fourchette à viande
Tenedor trinchar

art.	l. cm.
48278-83	32,5



Silicone basting spoon

Cucchiaione in silicone
Gießlöffel aus Silikon
Cuillère de service en silicone
Cuchara para servir de silicona

art.	cm.	l. cm.
48278-14	5,5x8	26,5



Perforated spatule

Paletta forata
Küchenwender, perforiert
Pelle ajourée
Pala perforada

art.	cm.
48278-85	33x8,5



Silicone dough scraper

Spatola in silicone
Teigschaber aus Silikon
Pelle en silicone
Paleta de silicona

art.	cm.	l. cm.
48278-28	5x9	28,5



Whisk

Frusta
Schneebeesen
Fouet
Batidor

art.	l. cm.
48278-18	24,5
48278-19	29,5



TURNERS SPATOLE

KITCHEN UTENSILS
UTENSILI DA CUCINA

SS PP



Stainless steel turners with polypropylene handle.

Spatole in acciaio inox con manico in polipropilene.



Pizza server
Spatola per pasticcio e pizza
Pizzawender
Pelle à pizza
Espátula pizza

art. cm.
18511-15 15,5x8,7



Hamburger turner
Spatola hamburger
Hamburgerspachtel
Pelle à hamburger
Espátula hamburguesa

art. cm.
18512-15 19x13,8



Lasagne spatula
Spatola lasagne
Lasagneheber
Pelle à lasagne
Espátula lasaña

art. cm.
18515-16 16,8x7,2



Triangular spatula
Spatola triangolare
Dreieckiger Spachtel
Spatule triangulaire
Espátula triangular

art.	cm.
18520-04	12x4
18520-06	12x6
18520-08	12x8
18520-10	12x10
18520-12	12x12



Hamburger turner
Spatola hamburger
Pfannenwender
Grand palette à hamburger
Espátula hamburguesa

art.	cm.
18516-24	24x7,2



Perforated hamburger turner
Spatola hamburger, forata
Pfannenwender, gelocht
Grand palette perforée
Espátula hamburguesa, perforada

art.	cm.
18517-24	24x7,2



Perforated turner
Paletta forata
Kuchenpalette, geschlitzt
Palette perforée
espátula perforada

art.	cm.
18510-07	13,5x7



Slotted spatula
Spatola forata
Pfannenwender, geschlitzt
Palette ajourée
espátula perforada

art.	cm.
18509-01	16x7,5



Slotted spatula
Spatola forata
Pfannenwender, geschlitzt
Palette ajourée
espátula perforada

art.	cm.
18509-02	15,6x5



Slotted spatula, flexible
Paletta forata, flessibile
Pfannenwender, geschlitzt, flexibel
Palette ajourée flexible
espátula perforada flexible

art.	cm.
18509-03	15,6x8,7



Bent icing spatula
Spatola cuoco con scalino
Confiseriepalette
Palette coudée
Espátula pastelera acodada

art.	cm.
18518-22	22x3,4
18518-26	25x3,7
18518-30	30x4,3



Straight icing spatula
Spatola cuoco
Back- und Glasurpalette
Spatule glaçage plate
Espátula pastelera lisa

art.	cm.
18519-15	15,5x3
18519-22	22x3,4
18519-26	26x3,7
18519-30	31x4,3
18519-35	36x5



Pie server
Paletta dolci
Gebäckpalette
Palette à gâteau
Espátula pasteles

art.	cm.
18513-14	14,5x6,5



Pie server serrated edge
Pala torta seghettata
Kuchenschaufel gezackte Kante
Pelle à gâteau côté dentelé
Pala pasteles filo dentado

art.	cm.
18514-17	16,3x5,8



Pie server serrated edge
Pala torta seghettata
Kuchenschaufel gezackte Kante
Pelle à gâteau côté dentelé
Pala pasteles filo dentado

art.	cm.
18514-18	17,3x5,8

Bent. – Con scalino.



LADLES MESTOLI

KITCHEN UTENSILS
UTENSILI DA CUCINA



The PADERNO ladle.
Handle-cup connection (one piece ladle). Thicker handle with rounded border.
Diameter and capacity stamped on the handle.

Il mestolo PADERNO.
Accoppiamento manico-coppa (mestolo uniprezzo). Manico con spessore maggiorato con bordi arrotondati. Indicazione sul manico del diametro e della capacità.



NSF
SS

One piece ladle
Mestolo unipezzo
Schöpflöffel, fugenlos
Louche monobloc
Cacillo monobloc

art.	Ø cm.	l. cm.	lt.
11970-06	6,5	30	0,07
11970-08	8,0	32	0,12
11970-09	9,0	33	0,20
11970-10	10,0	37	0,25
11970-11	11,0	38	0,33
11970-12	12,0	40	0,50
11970-14	14,0	44	0,75
11970-16	16,0	47	1,00



NSF
SS

Ladle, tube handle
Mestolo con manico a tubo
Schöpflöffel mit Rohrstiel
Louche avec manche tubulaire
Cacillo con mango tubolar

art.	Ø cm.	l. cm.	lt.
11968-18	18	75	1,5
11968-20	20	75	2,0
11968-24	24	75	4,0



NSF
SS

One piece perforated ladle
Mestolo forato unipezzo
Gelochter Schöpflöffel, fugenlos
Louche monobloc perforée
Cacillo monobloc perforado

art.	Ø cm.	l. cm.	lt.
11967-06	6,5	30	0,07
11967-08	8	32	0,12
11967-09	9	33	0,20
11967-10	10	37	0,25
11967-12	12	40	0,50
11967-14	14	44	0,75
11967-16	16	47	1,00



NSF
SS

Perforated ladle, tube handle
Mestolo forato con manico a tubo
Schöpflöffel, gelocht mit Rohrstiel
Louche perforée, manche tubulaire
Cacillo perforado mango tubolar

art.	Ø cm.	l. cm.	lt.
11967-18	18	75	1,5
11967-20	20	75	2,0
11967-24	24	75	4,0



NSF
SS

One piece side basting spoon
Mestolo becco a versare unipezzo
Saucenkelle quer, fugenlos
Cuillère à arroser monobloc
Cacillo monobloc para versar

art.	Ø cm.	l. cm.	lt.
11969-06	6,5	30	0,07
11969-37*	6,5	30	0,07

*Left handed. – Per mancini.



NSF
SS

One piece basting spoon
Cucchiaione unipezzo
Giesslöffel, fugenlos
Cuillère monobloc
Cucharón monobloc

art.	l. cm.
11982-38	38



NSF
SS

One piece perforated spoon
Cucchiaione forato unipezzo
Giesslöffel perforiert, fugenlos
Cuillère perforée monobloc
Cucharón perforado monobloc

art.	l. cm.
11984-38	38



NSF
SS

One piece spoon, crosswise
Cucchiaione obliquo unipezzo
Giesslöffel quer, fugenlos
Cuillère oblique monobloc
Cucharón obliquo monobloc

art.	l. cm.
11983-38	38
11983-37*	38

*Left handed. – Per mancini.



NSF
SS

One piece meat fork, 3 prongs
Forchettone 3 denti unipezzo
Fleischgabel 3 Zacken, fugenlos
Fourchette 3 dents, monobloc
Tenedor 3 dientes, monobloc

art.	l. cm.
11974-50	50
11974-70	70



NSF

SS

One piece meat fork, 2 prongs
Forchettone 2 denti unipezzo
Fleischgabel 2 Zacken, fugenlos
Fourchette 2 dents, monobloc
Tenedor 2 dientes, monobloc

art.	l. cm.
11975-50	50
11975-99	100



NSF

SS

One piece spatula
Paletta liscia unipezzo
Backschaufel, fugenlos
Spatule monobloc
Espátula lisa monobloc

art.	cm.	l. cm.
11972-10	10	36
11972-12	12	39



NSF

SS

One piece perforated spatula
Paletta forata unipezzo
Backschaufel perforiert, fugenlos
Spatule perforée monobloc
Espátula perforada monobloc

art.	cm.	l. cm.
11973-10	10	36
11973-12	12	39



NSF

SS

Perforated slice
Pala a ridurre
Reduzierspatel
Spatule à réduire
Espátula para reducir

art.	cm.	l. cm.
11976-50	12x15	50
11976-99	12x15	100



NSF

SS

One piece fish spatula
Paletta pesce unipezzo, forata
Fischwender, fugenlos
Pelle à poisson monobloc
Pala pescado, monobloc

art.	cm.	l. cm.
11985-34	15x20	42



NSF

SS

One piece skimmer
Schiumarola unipezzo
Schaumlöffel, fugenlos
Ecumoire monobloc
Espumadera monobloc

art.	Ø cm.	l. cm.
11971-08	8	29,0
11971-10	10	32,0
11971-12	12	35,0
11971-14	14	38,0
11971-16	16	41,0
11971-18	18	42,5
11971-20	20	44,5



NSF

SS

One piece skimmer, tube handle
Schiumarola unipezzo, manico a tubo
Schaumlöffel, fugenlos, mit Rohrstiel
Ecumoire monobloc, manche tubulaire
Espumadera monobloc, mango tubular

art.	Ø cm.	l. cm.
11971-25	25	75



NSF

SS

One piece ladle
Mestolo unipezzo
Schöpflöffel, fugenlos
Louche monobloc
Cacillo monobloc

art.	Ø cm.	l. cm.	lt.
11970-01	8	23	0,12

Short handle. – Manico corto.



NSF

SS

Side basting spoon
Mestolo con becco a versare
Saucenkelle mit seitlichem Ausguß
Cuillère à arroser
Cacillo para versar

art.	Ø cm.	l. cm.	lt.
11969-02	6,5	23	0,07

Short handle. – Manico corto.



NSF

SS

One piece spoon
Cucchiaione unipezzo
Giesslöffel, fugenlos
Cuillère monobloc
Cuchara monobloc

art.	l. cm.
11982-01	23,5

Short handle. – Manico corto.



NSF

SS

One piece meat fork
Forchettone unipezzo
Fleischgabel, fugenlos
Fourchette monobloc
Tenedor monobloc

art.	l. cm.
11975-01	26

Short handle. – Manico corto.



NSF

SS

One piece perforated spatula
Paletta forata unipezzo
Backschaufel perforiert, fugenlos
Spatule perforée monobloc
Espátula perforada monobloc

art.	cm.	l. cm.
11973-01	8x9,5	24

Short handle. – Manico corto.



NSF
SS

One piece skimmer
Schiumarola unipezzo
Schaumlöffel, fugenlos
Ecuimoire monobloc
Espumadera monobloc

art. Ø cm. l. cm.
11971-01 9 26

Short handle. – Manico corto.



SS

Ladle
Mestolo
Schöpflöffel
Louche
Cacillo

art. Ø cm. l. cm. lt.
41670-06 6 30 0,03
41670-09 9 32 0,13



SS

Skimmer
Schiumarola
Schaumlöffel
Ecuimoire
Espumadera

art. Ø cm. l. cm.
41671-11 11 32



SS

Slotted turner
Paletta forata
Küchenwender, geschlitzt
Pelle ajourée
Espátula perforada

art. l. cm.
41672-00 32



SS

Spaghetti spoon
Cucchiaio per spaghetti
Spaghettilöffel
Cuillère à spaghetti
Tenedor espaguetis

art. l. cm.
41673-00 32



SS

Meat fork
Forchettone
Fleischgabel
Fourchette
Tenedor

art. l. cm.
41674-00 32



SS

Basting spoon
Cucchiaione
Giesslöffel
Cuillère
Cuchara

art. l. cm.
41675-00 32



SS

Perforated spoon
Cucchiaione forato
Schöpfkelle, gelocht
Cuillère percée
Cuchara perforada

art. l. cm.
41676-00 32



SS

Sauce ladle
Cucchiaione salse
Saucenkelle
Cuillère à sauce
Cuchara salsas

art. l. cm.
41677-00 32

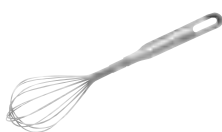

SS

Whisk
Frusta
Schneebeesen
Fouet
Batidor

art. l. cm.
41678-00 30



SS

Wall rack
Asta
Aufhängungstange
Tringle de cuisine
Asta para utensilios

art. l. cm.
41670-AA 40
41670-AB 60



SS

Mesh skimmer
Schiumarola a rete stirata
Schaumlöffel
Ecuimoire
Espumadera

art. Ø cm. l. cm.
11990-16 16 40



SS

Mesh skimmer
Schiumarola a rete passabrodo
Schaumlöffel
Ecuimoire
Espumadera

art. Ø cm. l. cm.
11991-16 16 40

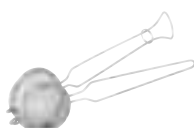

SS

Bird nest fryer
Colafritto
Nestbacklöffel
Nid à friture
Molde nido

art. Ø cm. l. cm.
42623-10 10 26



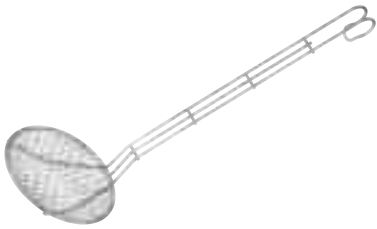

SS

Wire skimmer
Schiumarola a filo
Drahtlöffel
Araignée
Araña

art.	Ø cm.	l. cm.
12640-14	14	40
12640-16	16	40
12640-18	18	40
12640-20	20	50
12640-24	24	50
12640-28	28	50

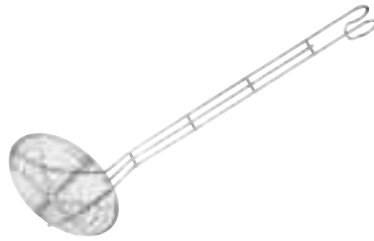

SS

Wire skimmer
Schiumarola a filo
Drahtlöffel
Araignée
Araña

art.	Ø cm.	l. cm.
12641-14	14	40
12641-16	16	40
12641-18	18	40
12641-20	20	50
12641-24	24	50
12641-28	28	50

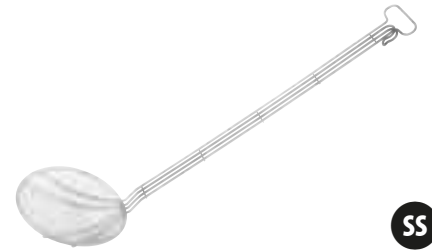

SS

Wire skimmer
Schiumarola a filo
Drahtlöffel
Araignée
Araña

art.	Ø cm.	l. cm.
12642-28	28	85



SS

French fry scoop
Pala per patate fritte
Frittenschaufel
Pelle à frites
Pala chips

art.	cm.
41929-00	20x19x6,5



ABS

French fry scoop
Pala per patate fritte
Frittenschaufel
Pelle à frites
Pala chips

art.	cm.
41929-02	23x20x5

Ambidextrous. – Ambidestro.



W

Spatula
Spatola
Schäber
Spatule
Espátula

art.	l. cm.
42907-01	25
42907-02	30
42907-03	35
42907-04	40
42907-06	50
42907-07	60
42907-08	80
42907-09	100
42907-10	120



W

Mixing spoon
Cucchiaione
Löffel
Cuillère
Cuchara

art.	l. cm.
42901-20	20
42901-25	25
42901-30	30
42901-35	35
42901-40	40



W

Spatula
Spatola
Schäber
Spatule
Espátula

art.	l. cm.
42907-30	30
42907-35	35
42907-40	40



W

Crepe spreader, 5 pcs
Spatole crêpes, 5 pz
Crêpe-Paletten, 5 Stk
Rateau à crêpes/raclettes, 5 pcs
Espátula crêpes, 5 pz

art.	cm.
42900-15	16,5x20
42900-24	18x24

Beech wood. – Faggio.



SS

Baster tube
 Pompetta per sugo
 Saft-Spritze
 Pompe à jus
 Bomba para jugo

art.	l. cm.
42863-00	20



SS
 PP
 PS

Marinating syringe, graduated
 Siringa per marinata, graduata
 Marinierspritze, graduert
 Seringue à marinade, graduée
 Jeringa para marinar, graduada

art.	Ø cm.	l. cm.	ml.
42862-00	3,5	24	30



SS

Fish-bone remover
 Pinza toglie lische
 Grätenentkerner
 Pince à arêtes
 Pinza para espinas

art.	l. cm.
42592-02	12



SS

Cooking tongs
 Pinza
 Kochzange
 Pince
 Pinza

art.	l. cm.
42904-01	16



SS

Cooking tongs
 Pinza
 Kochzange
 Pince
 Pinza

art.	l. cm.
42904-02	16



SS

Cooking tongs
 Pinza
 Kochzange
 Pince
 Pinza

art.	l. cm.
42904-03	15



SS

Sausage tongs
 Pinza per grill
 Grill-und Wurstzange
 Pince à saucisses
 Pinza para barbacoa

art.	l. cm.
41697-00	38



SS

Cooking tongs
 Pinza
 Kochzange
 Pince
 Pinza

art.	l. cm.
42902-31	30



SS

Cooking tongs
 Pinza
 Kochzange
 Pince
 Pinza

art.	l. cm.
42902-30	30





SS

Grill tweezer

Molla per grill
Grillzange
Pince à grill
Pinza para barbacoa

art.	l. cm.
41698-22	22,5
41698-30	30,0
41698-40	40,0



SS

Serving tongs

Pinza a servire
Pinza a servire
Servierzange
Pince à servir
Pinza para servir

art.	l. cm.	col.
42854C25	25	●
42854C30	30	●



SS

Serving tongs

Pinza a servire
Pinza a servire
Servierzange
Pince à servir
Pinza para servir

art.	l. cm.	col.
42854B25	25	●
42854B30	30	●



SS

Serving tongs

Pinza a servire
Pinza a servire
Servierzange
Pince à servir
Pinza para servir

art.	l. cm.	col.
42854Y25	25	○
42854Y30	30	○



SS

Serving tongs

Pinza a servire
Pinza a servire
Servierzange
Pince à servir
Pinza para servir

art.	l. cm.	col.
42854K25	25	●
42854K30	30	●



SS

Serving tongs

Pinza a servire
Pinza a servire
Servierzange
Pince à servir
Pinza para servir

art.	l. cm.	col.
42854R25	25	●
42854R30	30	●



SS

Serving tongs

Pinza a servire
Pinza a servire
Servierzange
Pince à servir
Pinza para servir

art.	l. cm.	col.
42854G25	25	●
42854G30	30	●



Cooking tongs, silicone

Pinza, silicone
Pinza, silicone
Kochzange aus Silikon
Pince en silicone
Pinza de silicona

art.	l. cm.
42903-29	29



Barbecue brush

Spazzola grill
Spazzola grill
Grill-Bürste
Brosse à grille
Cepillo para barbacoa

art.	cm.	l. cm.
41773-00	5,5x11	27

Brass bristles. – Setole in ottone.



SS

Whisk for basin

Frusta gigante
Frusta gigante
Kesselbesen
Fouet à bassine
Batidor gigante

art.	l. cm.
41980-99	125



Food-grade resin spatula

Spatola in resina alimentare
Spatola in resina alimentare
Rührspaten für Speisenzubereitung
Spatule en résine pour aliments
Espátula de resina para alimentos

art.	cm.	l. cm.
44061-08	15,7x10,8	80
44061-09	23,5x10,8	90
44061-12	23,5x10,8	117
44061-14	23,5x10,8	137



SS

Speed rack

Rastrelliera
Rastrelliera
Flaschenregal
Rack à bouteilles
Rack de botellas

art.	cm.	h.	bot.
44060-50	56x10,5	15,5	6
44060-80	81x10,5	15,5	8



SS

Bill spike
Spillone portascontrini
Kassenscheine-Aufstecknadel
Pique-addition
Pincha papeles

art.	Ø cm.	h.
12504-20	9	20

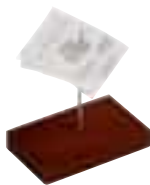

W

Bill spike
Spillone portascontrini
Kassenscheine-Aufstecknadel
Pique-addition
Pincha papeles

art.	cm.	l. cm.
42504-09	9x5,5	10,5



SS

Tickets-holder
Asta portascontrini
Bons-/Zettelhalter
Porte-fiches à billes
Barra de notas

art.	l. cm.
42509-25	25
42509-50	50



SS

Tab-grabber
Asta porta scontrini
Bons-/Zettelhalter
Porte-fiches
Barra de notas

art.	l. cm.
42509-60	60
42509-99	100



SS

Roll holder
Porta rotolo
Rollenhalter
Derouleur papier
Portarollos

art.	l. cm.
42512-35	30



SS

Wall film box
Supporto murale, porta pellicola
Wand-Folien-Abreißgerät
Dérouleur de film mural
Soporte de pared para film

art.	l. cm.
42513-30	30
42513-45	45

Roll max ø cm 13. – Rotolo ø max. cm 13.



PP

Additional plate stand
Anello distanziatore
Gestell für Zusatzteller
Support assiette supplémentaire
Soporte distanciador

art.	Ø cm.	h.
47605-23	19-21	6



PP

Plate cover
Copripiatto
Tellerglocke
Cloche
Cubreplatos

art.	Ø cm.	h.
47603-25	25	6,5
47603-27	27	6,5
44998-31	31	6,5



PC

Plate cover
Copripiatto
Tellerglocke
Cloche
Cubreplatos

art.	Ø cm.	h.
44997-22	21	6,8
44997-24	23	6,8
44997-26	26	6,8
44997-28	28	6,8



SAN

Plate cover
Copripiatto
Tellerglocke
Cloche
Cubreplatos

art.	Ø cm.	h.	for/per Ø
44991-22	22,0	7,0	21,5
44991-24	24,0	7,5	22,5-23
44991-28	28,0	6,5	26-26,5
44991-29	28,5	6,5	27-27,5



SS

Plate cover
Copripiatto
Tellerglocke
Cloche
Cubreplatos

art.	Ø cm.	h.
41683-26	26,5	4,3



SS

Funnel

Imbuto
Trichter
Entonnoir
Embudo

art.	Ø cm.
42562-12	12
42562-14	14
42562-16	16
42562-18	18
42562-20	20
42562-25	25
42562-30	30



PP

Funnel

Imbuto
Trichter
Entonnoir
Embudo

art.	Ø cm.
47604-08	8
47604-10	10
47604-12	12
47604-15	15
47604-18	18
47604-20	20
47604-24	24
47604-30	30



PP

Measuring jug

Caraffa graduata
Messbecher
Pichet gradué
Jarra de medidas

art.	Ø cm.	h.	lt.
47608-02	19	12	2,2



PP

Measuring jug

Caraffa graduata
Messbecher
Pichet gradué
Jarra de medidas

art.	Ø cm.	h.	lt.
47606-02	8,5	10,0	0,25
47606-05	10,5	10,5	0,50
47606-10	12,5	14,5	1,00
47606-20	13,5	17,0	2,00
47606-30	17,0	23,5	3,00
47606-50	20,0	25,5	5,00



PP

Measuring jug

Caraffa graduata
Messbecher
Pichet gradué
Jarra de medidas

art.	Ø cm.	h.	lt.	-
47607-02	7	12,0	0,25	NEW
47607-05	9	14,0	0,50	NEW
47607-10	12	16,5	1	-
47607-20	15	20,5	2	-

Lt. and ml. scale. Heat resistant up to 95°C.
Scala in lt e ml. Resistente fino a 95°C.



SS

Graduated measure jug

Misurino graduato
Messbecher, graduert
Mesure graduée
Jarra de medidas

art.	Ø cm.	h.	lt.
42581-01	7,5	5	0,10
42581-03	10,0	7	0,25
42581-05	11,5	11	0,50
42581-10	15,0	13	1,00
42581-15	15,5	15	1,50
42581-20	17	19	2,00



SS

Measuring spoons, 4 pcs

Misurini set 4 pz
Messlöffel Set 4-tlg.
Cuillères à mesurer 4 pcs
Cucharas medidoras 4 pz

art.	ml.
42615-04	1-2,5-5-15



SS

Measuring cups, 4 pcs

Misurini set 4 pz
Messlöffel Set 4-tlg.
Cuillères à mesurer 4 pcs
Cucharas medidoras 4 pz

art.	ml.
42616-04	60-80-125-250



SS

Lever dispenser
 Dosatore
 Hebeldosierspender
 Distributeur à manette
 Dispensador

art.	Ø cm.	h.
41528-21	21	22,5
41528-22	22	18,0

Suitable for 5 kg bucket. – Per bidone da kg 5.



AY

Dispenser
 Dosatore
 Dosierspender
 Doseur
 Dispensador

art.	ml.
47609-02	250
47609-03	350
47609-09	950
47609-13	1350



AY

Dispenser
 Dosatore
 Dosierspender
 Doseur
 Dispensador

art.	ml.
47609-04	375
47609-07	750
47609-12	1250
47609-16	1650



PE

Squeeze bottle
 Flacone dosatore
 Quetschflasche
 Flacon doseur
 Frasco dosificador

art.	ml.	col.
41526-R1	240	●
41526-R2	360	●
41526-R3	720	●



PE

Squeeze bottle
 Flacone dosatore
 Quetschflasche
 Flacon doseur
 Frasco dosificador

art.	ml.	col.
41526-B1	240	○
41526-B2	360	○
41526-B3	720	○



PE

Squeeze bottle
 Flacone dosatore
 Quetschflasche
 Flacon doseur
 Frasco dosificador

art.	ml.	col.
41526-G1	240	●
41526-G2	360	●
41526-G3	720	●



PE

Squeeze bottle, 4 pcs
 Flacone dosatore, 4 pz
 Quetschflasche, 4 Stk
 Flacon doseur, 4 pcs
 Frasco dosificador, 4 pz

art.	Ø cm.	h.	ml.
41526-01	3	8,5	30



PE

Squeeze bottle, 4 pcs
 Flacone dosatore, 4 pz
 Quetschflasche, 4 Stk
 Flacon doseur, 4 pcs
 Frasco dosificador, 4 pz

art.	Ø cm.	h.	ml.
41526-02	3,5	9,5	50



PE

Squeeze bottle
 Flacone dosatore
 Quetschflasche
 Flacon doseur
 Frasco dosificador

art.	Ø cm.	h.	ml.
41526-05	5,0	18	200
41526-06	5,5	19	350



PE

Triple nozzle squeeze bottle

Flacone dosatore, triplo ugello
Quetschflasche mit Dreifachdüse
Flacon doseur à trois becs
Frasco dosificador 3 boquillas

art.	ml.	col.
41520-08	235	○
41520-12	355	○
41520-16	470	○
41520-24	700	○



SS

Decorating spoons 2 pcs

Cucchiai decorazione 2 pz
Cucchiai decorazione 2 pz
Dekoration-Löffel 2 Stk
Cuillères pour décorer 2 pcs
Cucharas para decoración 2 pz

art.	l. cm.
47831-02	18-20



SS

Flour scoop

Sessola tonda
Mehlschaufel
Pelle à farine
Librador

art.	lt.
42609-10	0,10
42609-15	0,40
42609-20	1,00
42609-23	1,70
42609-25	2,80



PP

Flour scoop

Sessola
Mehlschaufel
Pelle à farine
Librador

art.	cm.	lt.
17610-01	20x7	0,10
17610-02	27,5x9,5	0,25
17610-05	32,5x12	0,50
17610-10	39x15	1,00



PA+
plus

Flour scoop

Sessola
Mehlschaufel
Pelle à farine
Librador

art.	cm.	lt.
12940-02	27,5x9,5	0,25
12940-05	32,5x12	0,50
12940-10	39x15	1,00
12940-20	48x18	2,00
12940-25	50x19,5	2,50



SS

Bread sieve

Setaccio pane
Brotsieb
Tamis à pain
Cernidor para pan

art.	Ø cm.	h.
12604-22	22	6,5
12604-30	30	6,5
12604-34	34	6,5
12604-40	40	6,5

8 eye per inch. – 8 fori per 2,5 cm2.



SS

Flour sieve

Setaccio farina
Mehlsieb
Tamis à farine
Cernidor para harina

art.	Ø cm.	h.
12605-22	22	6,5
12605-30	30	6,5
12605-34	34	6,5
12605-40	40	6,5

20 eye per inch. – 20 fori per 2,5 cm2.



SS

Sieve

Setaccio infarina pesce
Sieb
Tamis
Cernidor

art.	Ø cm.	h.
12606-30	30	6,5
12606-34	34	6,5

4 eye per inch. – 4 fori per 2,5 cm2.



SS

Sieve

Setaccio rete pasticcere

Sieb

Tamis

Cernidor

art.	Ø cm.	h.
12607-22	22	6,5
12607-30	30	6,5
12607-34	34	6,5

10 eye per inch. – 10 fori per 2,5 cm2.



SS

Kitchenbowl, with handles

Bacinella conica con maniglie

Schüssel mit Griffen

Bassine conique avec anses

Caldero cónico con asas

art.	Ø cm.	h.	lt.
11955-32	32	16,0	8,8
11955-36	36	18,5	12,8
11955-40	40	20,0	17,0
11955-45	45	22,5	24,5
11955-50	50	24,0	32,5



SS

Conical colander

Colapasta tronco conico

Gemüsesieher

Passoire à légumes

Colador cónico

art.	Ø cm.	h.	lt.
11930-24	24	12,0	3,5
11930-28	28	14,0	5,5
11930-32	32	16,0	8,8
11930-36	36	18,5	12,8
11930-40	40	20,0	17,0
11930-45	45	22,5	24,5
11930-50	50	24,0	32,5



SS

Conical colander

Colapasta tronco conico

Gemüsesieher

Passoire à légumes

Colador cónico

art.	Ø cm.	h.	lt.
11927-24	24	12,0	3,5
11927-28	28	14,0	5,5
11927-32	32	16,0	8,8
11927-36	36	18,5	12,8
11927-40	40	20,0	17,0
11927-45	45	22,5	24,5
11927-50	50	24,0	32,5



SS

Hemispherical mixing bowl

Bacinella emisferica

Schüssel

Bassine demi-ronde

Caldero semiesférico

art.	Ø cm.	lt.
11957-20	20	2,0
11957-25	25	3,7
11957-30	30	7,2
11957-35	35	10,5
11957-40	40	15,6



NSF

SS

Kitchenbowl low

Bacinella conica bassa

Schüssel, flach

Bassine

Caldero cónico

art.	Ø cm.	h.	lt.
12582-13	13,2	6,0	0,5
12582-17	16,5	7,5	1,0
12582-22	22,0	7,5	2,0
12582-24	24,0	9,5	3,0
12582-32	30,5	11,5	6,0
12582-34	32,5	14,0	8,0
12582-38	38,0	13,5	11,0
12582-40	40,0	15,0	14,0



NSF

SS

Kitchenbowl high

Bacinella conica alta

Tiefe Schüssel

Bassine haute

Caldero cónico alto

art.	Ø cm.	h.	lt.
12580-11	11,7	7,0	0,5
12580-17	15,5	9,0	1,0
12580-21	19,0	11,5	2,0
12580-24	22,0	12,0	3,0
12580-29	27,0	13,5	5,0
12580-30	29,0	15,0	6,0
12580-31	30,5	17,0	8,0
12580-36	35,5	18,5	11,0
12580-40	40,0	20,0	17,0
12580-45	45,0	22,0	25,0
12580-50	50,0	24,0	33,0



Conical colander, aluminium

Colapasta tronco conico, alluminio

Gemüsesieher, Aluminium

Passoire à légumes, alu

Colador cónico, aluminio

art.	Ø cm.	h.	lt.
16927-32	32	16,0	8,8
16927-36	36	18,5	12,8
16927-40	40	20,0	17,0
16927-45	45	22,5	24,5
16927-50	50	24,0	32,5



SS

Colander

Colapasta con cerchio

Gemüsesieher

Passoire à légumes

Colador con base

art.	Ø cm.	h.	lt.
11928-32	32	18,0	9,5
11928-36	36	19,0	12,0
11928-40	40	21,0	14,5



SS

Strainer

Colapasta semisferico
Stielsieb
Passoire hémispherique
Colador semiesférico

art.	Ø cm.	h.	lt.
11926-22	22	12	2,7
11926-26	26	14	4,0



SS

Strainer

Colapasta
Stielsieb
Passoire
Colador

art.	Ø cm.	h.	lt.
11924-18	18	11	2,8
11924-20	20	12	3,6
11924-22	22	13	5,0
11924-24	24	14	6,5
11924-28	28	15	9,3



Strainer, aluminium

Colapasta, alluminio
Stielsieb, Aluminium
Passoire, alu
Colador, aluminio

art.	Ø cm.	h.	lt.
16924-20	20	11	3,2
16924-24	24	13	6,0
16924-28	28	15	9,3



PP

Strainer

Colapasta
Stielsieb
Passoire
Colador

art.	Ø cm.
47610-22	22
47610-26	26
47610-30	30



PP

Strainer

Colapasta
Stielsieb
Passoire
Colador

art.	Ø cm.
47610-18	18



PE

Graduated bucket

Secchio graduato
Eimer mit Skala
Seau gradué
Cubo con medidas

art.	Ø cm.	h.	lt.
49889-09	27	26,2	9
49889-12	29	29,0	12
49889-15	31	30,8	15

With spout. – Con becco.



SS

Graduated bucket

Secchio graduato
Eimer mit Skala
Seau gradué
Cubo con medidas

art.	Ø cm.	h.	lt.
41960-08	28,5	20,5	8
41960-10	30,0	25,0	10
41960-12	31,0	27,0	12
41960-15	32,5	31,0	15



SS

Graduated bucket with bottom ring

Secchio graduato con base
Eimer mit Fuss u. Skala
Seau gradué avec base
Cubo con medidas y base

art.	Ø cm.	h.	lt.
41961-10	30,0	26,5	10
41961-12	31,0	28,5	12
41961-15	32,5	32,5	15



SS

Lid for bucket
Coperchio per secchio
Deckel für Eimer
Couvercle pour seau
Tapa para cubo

art.	Ø cm.
41962-10	30,0
41962-12	31,0
41962-15	32,5



PP

Mixing bowl
Bacinella tonda
Schüssel
Bassine ronde
Caldero semiesférico

art.	Ø cm.	h.	lt.
47611-01	19,0	7,9	1,0
47611-03	24,0	11,5	2,5
47611-05	28,0	13,5	4,5
47611-06	32,5	14,7	6,0
47611-09	36,0	16,5	9,0
47611-13	40,0	18,5	13,0



PP

Lid
Coperchio
Deckel
Couvercle
Tapa

art.	Ø cm.
47611-11	19,0
47611-14	24,0
47611-15	28,0
47611-16	32,5
47611-19	36,0
47611-23	40,0



PP

Mixing bowl
Bacinella tonda
Schüssel
Bassine ronde
Caldero semiesférico

art.	Ø cm.	h.	lt.
47600-16	16	7,0	0,9
47600-20	20	8,5	1,6
47600-24	24	10,0	2,8
47600-28	28	11,0	4,5
47600-32	32	12,5	6,5
47600-36	36	14,0	10,0
47600-40	40	15,5	13,5



PP

Mixing bowl
Bacinella semisferica
Schüssel
Bassine hémispherique
Caldero semiesférico

art.	Ø cm.	h.	lt.
44365-04	13,0	6,5	0,4
44365-10	17,0	8,5	1,0
44365-25	23,5	11,0	2,5
44365-40	28,0	14,5	4,0
44365-80	32,5	16,5	8,0
44365-99	38,0	18,0	10,0



PC

Mixing bowl
Bacinella semisferica
Schüssel
Bassine hémispherique
Caldero semiesférico

art.	Ø cm.	h.	lt.
44364-04	13,0	6,5	0,4
44364-10	17,0	8,5	1,0
44364-25	23,5	11,0	2,5
44364-40	28,0	14,5	4,0
44364-80	32,5	16,5	8,0
44364-99	38,0	18,0	10,0



SS

Mixing bowl
Bastardella semisferica
Schneeschlagkessel
Bassine hémispherique
Caldero con asas

art.	Ø cm.	h.	lt.
11952-22	22	12,0	2,7
11952-26	26	14,0	4,0
11952-32	32	18,0	9,5
11952-36	36	20,5	14,0
11952-40	40	21,5	18,0



SS

Mixing bowl without handles
Bastardella senza maniglie
Schneeschlagkessel ohne Griffe
Bassine hémispherique sans anses
Caldero sin asas

art.	Ø cm.	h.	lt.
11951-22	22	12,0	2,7
11951-26	26	14,0	4,0
11951-32	32	18,0	9,5
11951-36	36	20,5	14,0
11951-40	40	21,5	18,0



SS

Foot for mixing bowl

Base per bastardella
Fuss für Schneeschlagkessel
Base pour bassine hémispherique
Base para caldero

art.	Ø cm.	for/per Ø
11953-16	16	22-26
11953-22	22	32-36-40



SS

Kettle for mixing machines

Bacinella per planetaria
Schlagmaschinenkessel
Bol pour mélangeurs
Caldero para batidera

art.	Ø cm.	h.	lt.
11954-26	26	20,0	10,0
11954-30	30	25,0	16,0
11954-32	32	30,0	20,0
11954-36	36	28,5	25,0
11954-37	36	35,0	32,0
11954-40	40	35,5	40,0



SS

Kitchenbowl with handle

Tazzone con manico
Schlagschüssel mit Rohrstiel
Bol avec manche
Cazo bombeado

art.	Ø cm.	h.	lt.
41916-10	15	8,0	1,0
41916-15	17	9,0	1,2
41916-20	19	10,0	2,0



Induction adapter

Adattatore induzione
Induktion Adapterplatte
Disque relais pour induction
Adaptador para inducción

art.	Ø cm.
41922-16	16
41922-22	20

Removable handle in heat resistant material.
Manico estraibile in materiale termo resistente.



Manual salad spinner

Centrifuga manuale per verdura
Salatschleuder
Essoreuse manuelle à salade
Centrifugadora de ensalada

art.	Ø cm.	h.	lt.
49888-10	33	43	12
49888-20	43	52	25



SS

Soup strainer

Colino a rete
Suppensieb
Passe-bouillon
Colador a red

art.	Ø cm.	l. cm.
12622-07	7	12
12622-10	10	12
12622-12	12	17
12622-14	14	17
12622-16	16	17
12622-18	18	17
12622-20	20	17
12622-23	23	27
12622-26	26	27



SS

Strainer, double mesh

Colapasta doppia rete
Passiersieb, doppelnetz
Passoire, maille double
Colador doble red

art.	Ø cm.	l. cm.
12633-16	16	17
12633-18	18	17
12633-20	20	17
12633-23	23	27
12633-26	26	27



SS

Strainer

Colatutto
Sieb
Passoire
Colador multiuoso

art.	cm.	l. cm.
12630-22	22x18	19





SS

Strainer

Colino
Sieb
Passoire
Colador

art.	Ø cm.
41570-10	8



SS

Strainer, reinforced

Colapasta rinforzato
Grossküchensieb mit Verstärkung
Passoire renforcé
Colador reforzado

art.	Ø cm.	l. cm.
12635-23	23	27
12635-26	26	27
12635-30	30	44
12635-35	35	44



SS

Strainer

Colatutto gigante
Grossküchensieb
Passoire géant
Colador multiuso gigante

art.	Ø cm.	l. cm.
12636-32	32	40



SS

Chinese colander

Cornetto cinese
Spitzsieb
Passoire chinois
Colador chino

art.	Ø cm.
41925-14	14
41925-16	16
41925-18	18
41925-20	20
41925-22	22
41925-24	24
41925-26	26



SS

Chinese colander stand

Supporto per cornetto cinese
Träger für Spitzsieb
Support chinois
Soporte para colador chino

art.	Ø cm.	h.
41933-18	18	28

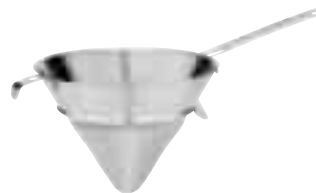

SS

Colander with wire gauze

Cornetto cinese a rete
Gazensieb
Chinois à gaze
Colador chino a red

art.	Ø cm.
11929-20	20
11929-24	24



SS

Chinese colander with wire protection

Cornetto con protezione
Spitzsieb mit Verstärkung
Chinois à gaze avec renfort
Colador chino con protección

art.	Ø cm.
11932-20	20
11932-24	24



SS

Soup strainer

Colino a rete
Suppen
Passe-bouillon
Colador a red

art.	Ø cm.
41931-08	8,5
41931-14	14,0
41931-16	15,0
41931-18	19,0



Bouillon cloth

Panno passabrodo
Bouillonstoffsieb
Etamine passe-bouillon
Paño para pasar caldo

art.	cm.	U. Pack
41932-05	87x70	5

Twisted cotton cloth with seam.
Tela di cotone ritorto, orlata.



Foodloops, silicone, 6 pcs
Laccetti da cucina, silicone, 6 pz
Silikonbänder, 6 Stk
Lacets de cuisson, silicone, 6 pcs
Lazos de silicona de cocina, 6 pz

art.	l. cm.
41595B44	22
41595B45	53



Presse canard, bronzo
Presse canard, bronzo
Presse canard, Bronze
Presse à canard, bronze
Prensador para canard, bronzo

art.	h.	Kg.
49845-01	52	16

Tinned. – Stagnato.



SS

Octopus-press
Pressapolipo
Krake-Prese
Presse à poulpe
Prensador para pulpo

art.	Ø cm.	h.
49760-00	10,5	20,5



SS

Tomato cutter
Affetta pomodori
Tomatenschneidgerät
Coupe-tomates
Cortador tomates

art.	cm.	Kg.
49837-05	30x14x18	2

Slice thickness 5,5 mm. – Spessore taglio 5,5 mm.



SS

Mozzarella/tomato cutter
Affetta mozzarella/pomodori
Mozzarella-/Tomatenschneidgerät
Coupe-mozzarella/tomates
Cortador mozzarella/tomates

art.	cm.	Kg.
49820-05	48x20x32	7,1

Also suitable for cutting lemons, oranges or kiwis, etc. Slice thickness 5,5 mm.

Adatto anche per tagliare limoni, arance o kiwi, ecc. Spessore fetta 5,5 mm.





SS

Cube cutter
Taglia cubi
Würfel-Schneidgerät
Coupe-cubes
Cortador en dados

art.	cm.	Kg.
49821-08	35,5x26x66	4

Dice thickness 8 mm. – Spessore taglio 8 mm.



SS

Vegetable cutter
Taglia verdure
Gemüseschneider
Machine à tourner les légumes
Cortador de verduras

art.	cm.	Kg.
49842-00	21x17,5x19	3,2

To make chateau potatoes, cocottes and fondants lenght from 4 to 8 cm. 3 position adjustable blade. – Per patate chateau, cocotte e fondenti di lunghezza da 4 a 8 cm. Lama con 3 regolazioni. di taglio.



SS

Pineapple coring tool
Svuota ananas
Ananasausstecher
Vide ananas
Saca corazón de piña

art.	Ø cm.	l. cm.
48280-10	2,5	24



SS

Pineapple slicer
Taglia ananas
Ananasteiler
Coupe-ananas en rondelle
Cortador de piña en rondajas

art.	Ø cm.	l. cm.
48218-00	2,5	24



SS

Pineapple-peeler/corer
Pela/svuota ananas
Ananasschälmaschine
Epluche-ananas
Pelador de piña

art.	cm.	Kg.
49818-00	45x39x72	18

Blade and pusher Ø 89 mm.
Lama e pressatore Ø 89 mm.

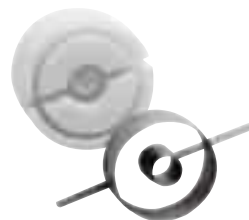

Additional pushers and blades
Pressatori e lame opzionali
Zusätzliche Presse und Messer
Poussoirs et couteaux supplémentaires
Empujador y cuchilla suplementarios

art.	des.	Ø cm.
49818-AC	blade/lama	7,4
49818-AD	pusher	7,4
49818-AE	blade/lama	10,2
49818-AF	pusher	10,2



SS

Fruit cutter
Trancia spicchi
Früchteschneider
Coupe-fruits
Cortador tomates

art.	cm.	Kg.
49838-08	38x26x58	3,3

8 wedges, for vegetables and fruits without stone. – 8 spicchi, per ortaggi e frutta senza nocciolo.



SS

Apple corer/wedger set of blades
Set lame levatorisolo e trancia spicchi
Apfelentkerner-/Schneidmesser
Lames évideur/coupe-pommes
Saca corazón y cortador para manzanas

art.	49838-98
------	----------

8 sections. – 8 sezioni.



Electric peeler

Pelatrice elettrica
Elektr. Schälmachine
Eplucheur électrique
Pelador eléctrico

art.	cm.	Kg.
49750-00	25x16x21,5	2



Professional apple peeler "KALI"

Pela mele professionale
Profi-Apfelschäler
Pèle-pommes, professionnel
Pelador de manzanas, profesional

art.	cm.	Kg.
49834-00	32x14x10	1,9



Apple peeler with screw

Pela mele con morsetto
Apfelschäler, Tischklemme
Pèle-pommes, socle serre-joint
Pelador de manzanas, fijación brida

art.	cm.
49835-00	30x10x17



Apple peeler, vacuum-power base

Pela mele con ventosa
Apfelschäler, Vakuum-Fuss
Pèle-pommes, socle vacuum
Pelador de manzanas, fijación ventosa

art.	cm.
49836-00	30x10x13



Apple corer/wedger

Trancia spicchi per mela
Apfelentkerner-/Schneider
Lames évideur/coupe-pommes
Cortador y descorazonador manzanas

art.	Ø cm.
48289-10	10

SS



Egg wedger

Taglia uova
Eierteiler
Tranche-oeufs
Cortahuevos

art.	Ø cm.	l. cm.
42597-00	6,5	21

SS



Egg top cutter

Apriuovo
Eierköpfer
Toque oeuf
Abridor de huevos

art.	Ø cm.	h.
42595-01	3,5	15

SS

To quickly and accurately remove the top of raw or soft-boiled eggs. – Per rimuovere in modo rapido e preciso la parte superiore delle uova crude o alla coque.



Egg-slicer, aluminum

Taglia uova, alluminio
Eierteiler, Aluminium
Tranche-oeufs rondelle, aluminium
Cortahuevos guitarra, aluminio

art.	cm.
42588-01	13,5x8x4,5



Egg-slicer duo

Taglia uova doppio
Eierteiler 2 in 1
Tranche-oeufs 2 emplacements
Cortahuevos doble

art.	cm.
42588-00	21x8x4,5



Egg container

Contentitore per uova
Eier-Behälter
Porte-oeufs
Contenedor para huevos

art.	cm.
47093-24	30x21,5x6,5



Egg rings 2 pcs

Anelli per uova 2 pz
Eierringe, 2 Stk
Ronds à oeufs, 2 pcs
Anillos para huevos, 2 pz

art.	Ø cm.	h.
42596-02	8	1,5

SS



Egg ring, non stick

Anello per uova, antiaderente
 Eierring, beschichtet
 Rond à oeufs, anti-adhésif
 Anillo para huevos, antiadherente

art.	Ø cm.	h.
42650-10	10	1,5



Egg ring, non stick

Anello per uova, antiaderente
 Eierring, beschichtet
 Rond à oeufs, anti-adhésif
 Anillo para huevos, antiadherente

art.	Ø cm.	h.
42650-11	11	1,5



Artichoke corer

Svuota carciofi
 Artischocken Entkerner
 Etrogneur à artichauts
 Saca corazon para alcachofas

art.	Ø cm.	h.
48288-02	8	8

Top-rack dishwasher-safe. ABS body and scoop, PP cover, stainless steel blade. – Lavabile in lavastoviglie nel cestello superiore. Corpo e palette in ABS, coperchio in PP, lama inox.



Brussel sprout cutter

Taglia cavolini di Bruxelles
 Rosenkohl-Schneider
 Coupe-choux de Bruxelles
 Cortador de coles de Bruselas

art.	cm.
48288-03	8x8x10

Dishwasher safe. SAN transparent body, ABS frame, PP base, stainless steel blade. – Lavabile in lavastoviglie. Corpo trasparente SAN, telaio in ABS, base in PP, lama inox.



NEW

Chicory cutter

Taglia puntarelle
 Chicoree-Schneider
 Coupe-chicorée
 Cortador de achicoria

art.	cm.
48288-05	10x10

No dishwasher safe. Birch plywood, aluminum rivets, stainless steel wire. – Non lavabile in lavastoviglie. Multistrato di betulla, ribattini in alluminio, filo inox.



SS

Mushroom cutter

Taglia funghi
 Pilze-Teiler
 Tranche-champignons
 Cortador de hongos

art.	Ø cm.	l. cm.
42598-00	7,6	20,7



SS

Avocado peeler and slicer

Pela/taglia avocado
 Avocadoschäler-/Teiler
 Pèle et tranche avocat
 Pelador y cortador de aguacete

art.	l. cm.
48286-62	18,5



SS

Large vegetable slicer

Pelaverdure
 Gemüseschäler
 Eplucheur à légumes
 Pelador de verduras

art.	cm.
48286-64	22x10



SS

Potato peeler

Pelapatate
 Sparschäler
 Eplucheur
 Pelador de patatas

art.	cm.
42589-00	5x4

For left or right handed. – Per mancini e destrorsi.



SS

Potato ricer with 3 discs
Schiacciapatate, 3 griglie
Kartoffelpresse, 3 Roste
Presse-purée, 3 grilles
Pasapurés, 3 discos

art.	Ø cm.	cm.
42566-03	8,5	30x10x11

Discs/Dischi: ø 2,4 - 4,4 - 6,5 mm.



SS

French fry cutter
Taglia patate
Kartoffelschneidergerät
Coupe-frites
Cortador de patatas fritas

art.	cm.	Kg.
49832-10	24x44x34	11

Cutting knife/Quadro di taglio: 10 mm.



SS

French fry cutter
Taglia patate
Kartoffelschneidergerät
Coupe-frites
Cortador de patatas fritas

art.	cm.
49831-10	28x11x16,5

Functional and solid. With suction base. Space-saving size. Accurate cutting 10 mm. Easy to clean – Funzionale e solido. Base con ventose. Salvaspazio. Taglio preciso, 10 mm. Facile da pulire.



SS

French fry cutter
Taglia patate
Kartoffelschneidergerät
Coupe-frites
Cortador de patatas fritas

art.	cm.	Kg.
49832-02	26x9x12,5	1,2

Cutting knives/Quadri di taglio: 9x9 - 12x12 mm.



Herb scissors, 5 blades
Forbice per erbe, 5 lame
Kräuterschere, 5 Klingen
Ciseaux à herbes, 5 lames
Tijeras hierbas, 5 cuchillas

art.	l. cm.
18277-00	10



SS

Tortillas wedger
Taglia tortillas
Tortillasteiler
Coupe-tortillas
Corta tortillas

art.	Ø cm.
42599-06	25
42599-08	25

Wedges/Spicchi: 6 - 8.



SS

PS

Cheese rotary grater
Grattugia formaggio rotatoria
Drehe-Käse-Raffel
Frisette à fromage
Ralladora giratoria para queso

art.	Ø cm.	h.
48281-22	22	17

Oak wood base. – Base legno di quercia.



SS

Cheese wire cutter
Lira per formaggi
Käse Drahtschneider
Lyre à fromage
Lira para quesos

art.	cm.
48282-21	20,5x26,7



Grater, automatic
 Grattugia automatica
 Reibe, automatisch
 Râpe automatique
 Rallador automático

art. cm.
 48295-10 20x5,4

Hermetic container, removable, with lid, 2 blades.
Ideal for cheese, nuts, chocolate, etc.
 Recipiente ermetico, removibile, con cop., 2 lame.
 Ideale per formaggio, noci, cioccolato, ecc.



Garlic press, chromed
 Spremiaglio, cromato
 Knoblauchpresse, verchromt
 Presse-ail, chromé
 Prensador de ajo, cromado

art. cm. l. cm.
 42565-00 3,5x2,5 14,5



Olive seed remover, chromed
 Snocciolatore, cromato
 Olivenentsteiner, verchromt
 Dénoyauter, chromé
 Quita pepa/hueso, cromado

art. l. cm.
 42563-00 17



Cherry core stripper
 Snocciolatore
 Kirschenentsteiner
 Dénoyauter de cerises
 Quita pepa/hueso

art. Ø cm. h.
 42563-44 10 34



Mandoline
 Mandolino
 Gemüsehobel Mandoline
 Mandoline
 Mandolina

art. cm. Kg.
 49829-11 39x12,5x5,5 1,7

Equipped with 7 interchangeable blades.
 Dotato di 7 lame intercambiabili.



Slicer Mandoline, Grand Gourmet
 Mandolino Grand Gourmet
 Gemüsehobel Grand Gourmet
 Mandoline Grand Gourmet
 Mandolina Grand Gourmet

art. cm. Kg.
 49830-60 40x12x28 1,6

38 blades, 10 mm. – 38 lame, 10 mm.

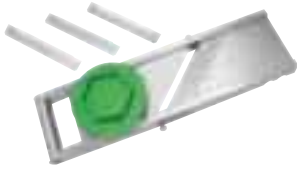

SS

Mandoline

Mandolino
Gemüsehobel Mandoline
Mandoline
Mandolina

art.	cm.	Kg.
49752-00	33,5x11x2,3	0,6

3 interchangeable blades of 2-3-6 mm.
3 lame intercambiabili da 2-3-6 mm.



ABS

Japanese Mandoline slicer

Mandolino giapponese
Japanese Gemüsehobel
Mandoline japonaise
Mandolina japonés

art.	cm.	Kg.
49753-06	11x31,5x3	0,3
49753-09	15x35x3,3	0,5

1 plain blade and 3 blades of 1-2-3 mm.
1 lama liscia e 3 lame da 1-2-3 mm.



SS

Cutter/corer

Intaglia verdure
Ausstechforme
Découpoir
Sacabocados

art.	cm.
48286-70	3,7x8,5x9

Cutting ø 3,4 cm. – Taglio ø 3,4 cm.



ABS

SS

Spiral vegetable slicer 3-blade

Taglia verdure 3-lame
Gemüseschneider 3-Messer
Coupe légumes 3 lames
Cortador de verduras 3 cuchillas

art.	cm.
49827-99	30x14x22

3 interchangeable s/s blades (3 - 6 mm. and 1 straight blade for ribbon cuts). – 3 lame inox intercambiabili (3 - 6 mm. e 1 lama dritta per taglio a nastro).



ABS

SS

Spiral vegetable slicer 7-blades 8-cuts

Taglia verdure 7-lame 8-tagli
Gemüseschneider 7-Messer 8-Schnitte
Coupe légumes 7-lames 8-coupees
Cortador de verduras 7-cuchillas 8-cortes

art.	cm.
49827-77	14,3x23,8x14,3

Includes: 4 mm straight blade, 10 mm chipper blade, 1,5 mm wavy blade, 2,5 mm straight blade, 2 mm Angel hair blade, 3 mm shredder blade, 6 mm chipper blade. Top-rack dishwasher-safe.
Include 2 lame lisce mm 2,5 e 4, lama ondulata da 1,5 mm, lama capelli d'angelo da 2 mm, 3 lame taglio spaghetti mm. 3, 6 e 10. Lavabile in lavastoviglie nel cestello superiore.



SS

Strip slicer

Taglia verdure
Gemüseschneider
Coupe-lanières
Cortador de verduras japonés

art.	cm.	Kg.
49823-00	20x20x25	1,9

Width of cut 15 cm. Max vegetables length 11 cm. and ø 17 cm. – Larghezza taglio 15 cm. Lunghezza max verdura 11 cm. e ø 17 cm.



ABS

Strip slicer

Taglia verdure
Gemüseschneider
Coupe lanière
Cortador de verduras

art.	cm.
49823-89	28x25x16,5

Width of cut 13 cm. Thickness 0,5 mm.
Larghezza taglio 13 cm. Spessore 0,5 mm.



ABS

Strip & spaghetti slicer

Taglia verdure
Gemüseschneider
Coupe lanière et spaghetti
Cortador de verduras japonés

art.	cm.
49823-99	28x25x16,5

Width of cut 13 cm. 2 blades 130x0,5 - 1x1,2 mm.
Larghezza taglio 13 cm. 2 lame 130x0,5 - 1x1,2 mm.



ABS
SS

Vegetable cutter LE ROUET GOURMET

Taglia verdure
Gemüseschneider
Coupe légumes
Cortador de verduras

art.	cm.	Kg.
49827-03	13,5x36x24,3	2,4

Cutting blocks 1-2-4 mm. Cutting thickness blade guirlandes 1>4 mm. – Pettini taglio 1-2-4 mm. Spessore taglio lama guirlandes 1>4 mm.



SS

Decoration tools 22 pcs

Attrezzi decoro, 22 pezzi
Dekoriersatz, 22-Tlg.
Outils de décor 22 pcs
Herramientas decoración 22 pz

art.	cm.
48286-13	38,5x29



SS

Decoration tools 18 pcs

Attrezzi decoro, 18 pz
Dekoriersatz, 18-Tlg.
Outils de décor 18 pcs
Herramientas decoración 18 pz

art.
48286-03



SS

Thai knife

Stiletto thailandese
Thai-Messer
Stylet thaï
Cuchillo thaï

art.	l. cm.
48286-08	16



Ice knife

Coltello ghiaccio
Eis-Messer
Couteau à glace
Cuchillo para hielo

art.	l. cm.	gr.
47885-01	14+10,5	200



Chisel V shape

Scalpello ghiaccio a V
Eismeissel
Ciseau à glace
Cinsel a V para hielo

art.	l. cm.	gr.
47885-02	31,5	200



Chisel flat medium

Scalpello ghiaccio 3 lati smussati
Eismeissel
Ciseau à glace
Cinsel para hielo

art.	l. cm.	gr.
47885-03	50	600



Chisel flat big

Scalpello ghiaccio 1 lato smussato
Eismeissel
Ciseau à glace
Cinsel para hielo

art.	l. cm.	gr.
47885-04	74,5	820



Ice chisel set 4 pcs

Scalpelli ghiaccio 4 pz
Eismeissel 4 Stk
Ciseaux à glace 4 pcs
Cinseles para hielo 4 piezas

art.	Kg.
47885-05	1,93



Butter churn

Mantecatore per burro
Butterfaß
Baratte à beurre
Mantequera

art.	cm.	lt.
48294-01	11,5x11,5x40	1,6



Butter mold

Stampo per burro
Butterform
Moule à beurre
Molde para mantequilla

art.	cm.	gr.
48294-02	12,2x6,6x4,3	80
48294-03	15,8x9x5	125



Butter mold

Stampo per burro
Butterform
Moule à beurre
Molde para mantequilla

art.	cm.	gr.
48294-04	21x9,4x5,8	250



Grater, non-slip handle

Grattugia, manico antiscivolo
Reibe, Rutschfestes Griff
Râpe queue antidérapant
Rallador mango antiderrapante

art.	cm.	l. cm.
42560-01	4x22	38,5



Grater, non-slip handle

Grattugia, manico antiscivolo
Reibe, Rutschfestes Griff
Râpe queue antidérapant
Rallador mango antiderrapante

art.	cm.	l. cm.
42560-02	4x22	38,5



Grater, non-slip handle

Grattugia, manico antiscivolo
Reibe, Rutschfestes Griff
Râpe queue antidérapant
Rallador mango antiderrapante

art.	cm.	l. cm.
42560-03	4x22	38,5



Grater, non-slip handle

Grattugia, manico antiscivolo
Reibe, Rutschfestes Griff
Râpe queue antidérapant
Rallador mango antiderrapante

art.	cm.	l. cm.
42560-04	7,7x13,3	30



Grater, non-slip handle

Grattugia, manico antiscivolo
Reibe, Rutschfestes Griff
Râpe queue antidérapant
Rallador mango antiderrapante

art.	cm.	l. cm.
42560-05	7,7x13,3	30



Grater, non-slip handle

Grattugia, manico antiscivolo
Reibe, Rutschfestes Griff
Râpe queue antidérapant
Rallador mango antiderrapante

art.	cm.	l. cm.
42560-06	7,7x13,3	30



Grater, non-slip handle
 Grattugia, manico antiscivolo
 Reibe, Rutschfestes Griff
 Râpe queue antidérapant
 Rallador mango antiderrapante

art. cm. l. cm.
 42560-07 7,7x13,3 30



Grater, non-slip handle
 Grattugia, manico antiscivolo
 Reibe, Rutschfestes Griff
 Râpe queue antidérapant
 Rallador mango antiderrapante

art. cm. l. cm.
 42560-08 7,7x13,3 30



Grater, non-slip handle
 Grattugia, manico antiscivolo
 Reibe, Rutschfestes Griff
 Râpe queue antidérapant
 Rallador mango antiderrapante

art. cm. l. cm.
 42560-09 7,7x13,3 30



Nutmeg grater
 Grattugia noce moscata
 Muskatreibe
 Râpe à muscade
 Rallador nuez moscada

art. cm.
 42556-00 4,5x14



Spatzle sieve
 Grattugia per spatzle
 Spätzle-Reibe
 Grille à spatzle
 Rallador para spatzle

art. cm.
 49844-01 31x10,5x6



4-ways grater
 Grattugia 4 tagli
 Vierkantreibe
 Râpe 4 faces
 Rallador 4 caras

art. cm.
 42569-04 10x8x23



Dumplin maker
 Stampo panzerotti
 Knödel-Form
 Moule à chaussons
 Molde para empanadillas

art. mm.
 49843-05 62, 82, 104, 177



Safety can opener
 Apriscatole sicuro
 Sicherheitsdosenöffner
 Ouvre-boîte de sûreté
 Abrelatas de seguridad

art. cm.
 48222-01 12,5x8



Universal can opener

Apriscatole universale, nichelato
Universal-Dosenöffner
Ouvre-boîte, universel
Abrelatas universal

art.	cm.
48220-00	8x7



Can opener, PP handle

Apriscatole, impugnatura PP
Dosenöffner, Griffe aus PP
Ouvre-boîte, poignées PP
Abrelatas, mango PP

art.	l. cm.
48280-03	21



Electric sieve

Passaverdura elettrico
Elektropassiergerät
Moulin électrique
Molino eléctrico

art.	Ø cm.	h.	kg./H	Kg.
49879-37	37	108	300	23,5

Equipped with 3 mm disc. – Griglia 3 mm.

SS



Sieve on tripod, tinned

Passaverdura stagnato con supporto
Passiergerät, verzinkt, mit Träger
Moulin étamé sur pied
Molino estañado sobre pie

art.	Ø cm.	h.	Kg.
42577-39	39	80	14

Equipped with 3 mm disc. – Griglia 3 mm.



Tomato juicer sieve

Passapomodoro professionale
Profi-Tomatenpassiergerät
Moulin à tomates professionnel
Molino para tomates, profesional

art.	Ø cm.	h.
42576-00	21	50

Equipped with 1 mm disc. – Griglia 1 mm.



Herb mill

Macinaerbe
Kräutermühle
Moulin fines herbes
Molino de hierbas finas

art.	cm.
42558-00	7x22

SS



Sieve, 3 discs

Passaverdura, 3 griglie
Passiergerät, 3 Roste
Moulin inox, 3 grilles
Molino inox, 3 rejillas

art.	Ø cm.	h.	Kg.
42571-20	19	16,5	0,46
42572-24	24	16,5	0,82

Discs: 1,5 - 2 - 4 mm. – Griglie: 1,5 - 2 - 4 mm.

SS



Sieve, 3 discs

Passaverdura, 3 griglie
Passiergerät, 3 Roste
Moulin inox, 3 grilles
Molino inox, 3 rejillas

art.	Ø cm.	h.	Kg.
42570-32	31	25	1,4

Discs: 1,5 - 2,5 - 4 mm. – Griglie: 1,5 - 2,5 - 4 mm.

SS



Sieve, tinned, 3 discs

Passaverdura stagnato, 3 griglie
Passiergerät, verzinkt, 3 Roste
Moulin étamé, 3 grilles
Molino estañado, 3 rejillas

art.	Ø cm.	h.	Kg.
42573-31	31	25	1,4

Discs: 1,5 - 2,5 - 4 mm. – Griglie: 1,5 - 2,5 - 4 mm.



SS

Sieve, 1 disc
 Passaverdura, 1 griglia
 Passiergerät, 1 Rost
 Moulin inox, 1 grille
 Molino inox, 1 rejilla

art.	Ø cm.	h.	Kg.
42574-37	37	32	3,5

Equipped with 3 mm disc. – Griglia 3 mm.



Sieve, tinned, 1 disc
 Passaverdura stagnato, 1 griglia
 Passiergerät, verzinkt, 1 Rost
 Moulin étamé, 1 grille
 Molino estañado, 1 rejilla

art.	Ø cm.	h.	Kg.
42575-37	37	32	3,5

Equipped with 3 mm disc. – Griglia 3 mm.



42570 - 42573

42574 - 42575
 42577 - 49879



SS

Table top can opener
 Apriscatole da banco
 Tisch-Dosenöffner
 Ouvre-boîte
 Abrelatas

art.	cm.	Kg.
49867-01	28x12,2x77,5	5

With screw base. Patented opening system. Opens round cans any sizes securely from 8 to 50 cm height), leaves smooth and not sharp edges. The cap can be reused. Dishwasher safe. Base da avvitare. Sistema di apertura brevettato. Per scatole rotonde di tutte le dimensioni (h da 8 a 50 cm). Rifilo netto dei bordi esterni. Nessun rischio di taglio. Possibilità di riutilizzare il coperchio dalla scatola. Lavabile in lavastoviglie.



SS

Table top can opener
 Apriscatole da banco
 Tisch-Dosenöffner
 Ouvre-boîte
 Abrelatas

art.	cm.	Kg.
49867-02	28x12,2x77,5	5

With clamp base. Patented opening system. Opens round cans any sizes securely from 8 to 50 cm height), leaves smooth and not sharp edges. The cap can be reused. Dishwasher safe. Base con morsetto. Sistema di apertura brevettato. Per scatole rotonde di tutte le dimensioni (h da 8 a 50 cm). Rifilo netto dei bordi esterni. Nessun rischio di taglio. Possibilità di riutilizzare il coperchio dalla scatola. Lavabile in lavastoviglie.



Table top can opener
 Apriscatole da banco
 Tisch-Dosenöffner
 Ouvre-boîte
 Abrelatas

art.	l. cm.
19810-00	56

Can size up to height 45 cm. Clamp base and bar in die-cast aluminum, steel head. Table fixing either with screws or clamp. – Altezza scatola fino a 45 cm. Corpo in alluminio pressofuso, testa in acciaio, fissaggio a viti o morsetto.



Table top can opener, steel
 Apriscatole da banco, acciaio
 Tisch-Dosenöffner, Stahl
 Ouvre-boîte, acier
 Abrelatas, acero

art.	l. cm.
49811-00	40

Can size up to height 30 cm. Table fixing with clamp base. – Altezza scatola fino a 30 cm. Fissaggio a morsetto.



SS

Table top can opener
 Apriscatole da banco
 Tisch-Dosenöffner
 Ouvre-boîte
 Abrelatas

art.	l. cm.
49812-00	55

Can size up to height 40 cm. Table fixing with clamp base. – Altezza scatola fino a 40 cm. Fissaggio a morsetto.



SS

Electric can opener
 Apriscatole elettrico
 Elektrodosenöffner
 Ouvre-boîte électrique
 Abrelatas eléctrico

art.	cm.	Kg.
49814-00	44x25x75	13

Dual speed motor. Opens all can shapes from 50 to 270 mm height. – Motore a 2 velocità. Per tutti i formati di scatola da 50 a 270 mm di altezza.

THERMOMETERS TERMOMETRI

KITCHEN UTENSILS
UTENSILI DA CUCINA





SS

Meat roasting thermometer

Termometro arrosti
Braten-Thermometer
Thermomètre à rôtir
Termómetro asado

art.	Ø cm.	div	range
49705-00	4,5	1°C	0+120°C

Penetration probe 13 cm. – Sonda l. 13 cm.



SS

Meat roasting thermometer

Termometro arrosti
Braten-Thermometer
Thermomètre à rôtir
Termómetro asado

art.	Ø cm.	range
19705-00	5	+54+88°C

Steam ø 6x107 mm. – Sonda ø 6x107 mm.



SS

Cooking & frying thermometer

Termometro fritti
Back-Thermometer
Thermomètre à friture
Termómetro frituras

art.	Ø cm.	div	range
19706-00	5	5°C	+50+200°C

Steam ø 5x311 mm. – Sonda ø 5x311 mm.



SS

Milk frothing thermometers, 3 pcs

Termometri latte/barista, 3 pz
Mich-Thermometer, 3 Stk
Thermomètres à lait, 3 pièces
Termómetros leche, 3 pz

art.	Ø cm.	div	range
49709-03	4,5	1°C	-10+110°C

Red, green and blue, to easily identify different types of milk used, to avoid cross-contamination. Stem 175 mm. – Rosso, verde e blu, per identificare facilmente i diversi tipi di latte utilizzati, per evitare la contaminazione incrociata. Stelo 175 mm.



Sugar thermometer

Termometro per zucchero
Zuckerthermometer
Thermomètre à sucre
Termómetro azúcar

art.	l. cm.	div	range
47843-00	30	1°C	+80+200°C

Stainless steel housing. – Guaina inox.



Sugar/jam thermometer

Termometro per zucchero/marmellata
Zucker- und Marmeladenthermometer
Thermomètre à sucre et confiture
Termómetro azúcar y mermelada

art.	div	range
47843-05	2°C	+40+200°C

Brass. – Ottone. Dim. 4,7x20 cm.



Baker's thermometer

Termometro per panettiere
Bäckerthermometer
Thermomètre boulanger
Termómetro panadero

art.	l. cm.	div	range
49712-00	30	1°C	-10+60°C

Plastic housing. – Guaina plastica.



SS

Oven thermometer

Termometro per forno
Ofenthermometer
Thermomètre à four
Termómetro horno

art.	Ø cm.	div	range
19709-00	7	10°C	+50+300°C



ABS

Fridge/freezer thermometer

Termometro frigo/freezer
Kühlschrank-Thermometer
Thermomètre à réfrigérateur
Termómetro congelador

art.	Ø cm.	div	range
49885-02	7	1°C	-50+50°C



SS

Fridge/freezer thermometer

Termometro frigo/freezer
Kühlschrank-Thermometer
Thermomètre à réfrigérateur
Termómetro congelador

art.	Ø cm.	div	range
19702-00	6	1°C	-30+30°C



ABS

Digital thermometer

Termometro digitale
Digitalthermometer
Thermomètre digitale
Termómetro digital

art.	div	range
49887-00	0,1°C	-50+70°C

Dim. cm. 1,5x5x7



ABS

Digital fridge thermometer

Termometro digitale per frigorifero
Kühlschrank-Digitalthermometer
Thermomètre digitale à réfrigérateur
Termómetro digital para refrigerador

art.	div	range
49887-02	0,1°C	-9,9+49,9°C

Dim. Cm. 2,6x4,5x7,3. Water resistant IP65.
Features a food safety zone icon in the display that indicates when the temperature is outside the range of 0 to 5°C. – Resistente all'acqua IP65. Un'icona indica sul display quando la temperatura è al di fuori dell'intervallo da 0 a 5°C.



Room/wall thermometer

Termometro da muro
Wandthermometer
Thermomètre à mur
Termómetro de pared

art.	div	range
49702-00	1°C	-30+50°C

Dim. cm. 20,5x4. Without mercury.
Senza mercurio.

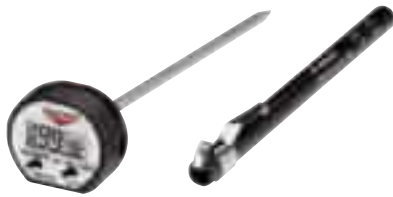

Pocket thermometer

Termometro da tasca
Taschenthermometer
Thermomètre à poche
Termómetro digital

art.	div	range
19701-00	0,1°C	-40+150°C

S/steel steam 130 mm. – Sonda inox 130 mm.



Digital thermometer

Termometro digitale
Digitalthermometer
Thermomètre digitale
Termómetro digital

art.	div	range
49710-00	1°C	-50+300°C

IP 65. Probe 135 mm. ø 2,5 mm.
Sonda 135 mm. ø 2,5 mm.



Pocket thermometer

Termometro da tasca
Taschenthermometer
Thermomètre à poche
Termómetro digital

art.	div	range
49701-00	0,1°C	-50+200°C

Probe 125 mm. ø 3,5 mm.
Sonda 125 mm. ø 3,5 mm.



Digital thermometer

Termometro digitale
Elektronisches Thermometer
Thermomètre digital
Termómetro digital

art.	div	range
49715-00	0,1°C	-50+300°C

Probe 125 mm. ø 3,5 mm.
Sonda 125 mm. ø 3,5 mm.



Digital thermometer

Termometro digitale
Elektronisches Thermometer
Thermomètre digital
Termómetro digital

art.	div	range
49716-00	0,1°C	-50+300°C

Dim. cm. 1,9x7x15,2. Countdown/up 99h-59m.



Digital thermometer

Termometro digitale
Elektronisches Thermometer
Thermomètre digital
Termómetro digital

art.	div	range
49883-00	0,1°C	-50+300°C

Dim. cm. 13x5,5x2,5. Probe 13 cm. ABS case incl. Biomaster AT. – Involucro ABS con Biomaster.
Sonda 13 cm.



Multi-function thermometer

Termometro multifunzione
Multifunktions-Thermometer
Thermomètre multifonction
Termómetro multifunción

art.	div	range
49988-00	0,1°C	-19,9+149,9°C

Dim. cm. 2,5x7,3x12,3. Probe 125 mm. ø 3,5.
Housing & probe handle incl. Biomaster AT.
Involucro e manico sonda con Biomaster. Sonda 125 mm. ø 3,5.



Infrared thermometer

Termometro a infrarossi
Infrarot-Thermometer
Thermomètre infrarouge
Termómetro infrarrojo

art.	div	range
49986-00	0,1°C	-49,9+349,9°C

Dim. cm. 2,5x5,2x10



Infrared thermometer

Termometro a infrarossi
Infrarot-Thermometer
Thermomètre infrarouge
Termómetro infrarrojo

art.	div
49884-08	0,1/1°C

Dim. cm. 4x6,6x15,5. Range infrared-Infrarossi: -60 to 500°C – Range probe-Sonda: -64 to 1370°C.



Infrared thermometer

Termometro a infrarossi
Infrarot-Thermometer
Thermomètre infrarouge
Termómetro infrarrojo

art.	div	range
49717-00	1°C	-50+400°C

Dim. cm. 17,5x4x7,2



Infrared thermometer

Termometro a infrarossi
Infrarot-Thermometer
Thermomètre infrarouge
Termómetro infrarrojo

art.	div	range
49987-00	0,1°C	-50+330°C

Dim. cm. 3,6x8,8x13,1

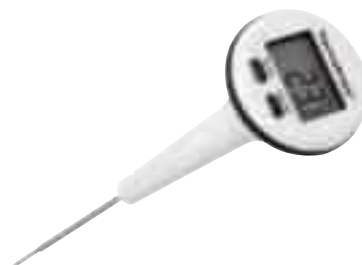

Waterproof thermometer

Termometro waterproof
Waterproof-Thermometer
Thermomètre waterproof
Termómetro waterproof

art.	div	range
49711-00	0,1°C	-50+300°C

Dim. Ø 51x178 mm. Waterproof IP66. Auto-rotating display. S/steel penetration probe Ø 2,5x70 mm stainless steel, Ø 1,6 mm tip.
Impermeabile IP66. Display a rotazione automatica. Sonda di penetrazione inox Ø 2,5x70 mm., punta Ø 1,6 mm.



ABS
SS

Digital thermo whisk

Termometro digitale con frusta
Schneebeesen mit Thermometer
Thermo-fouet digital
Termo-batidor digital

art.	l. cm.	range
49728-00	30	-30+300°C





Spatula with thermometer

Spatola con termometro
Rührspatule mit Thermometer
Spatule avec thermomètre
Espátula con termómetro

art. range
49729-00 -50+300°C

Dim. cm. 26x4x1,8



Digital thermometer

Termometro digitale
Elektronisches Thermometer
Thermomètre digital
Termómetro digital

art.	div	range	col.
49880-10	0,1/1°C	-49,9+299,9°C	●
49880-11	0,1/1°C	-49,9+299,9°C	●
49880-12	0,1/1°C	-49,9+299,9°C	●

Dim. cm. 1,9x5x15,7. IP67. S/steel probe Ø 3,3 x 110 mm. folds back through 180°.



Digital thermometer

Termometro digitale
Elektronisches Thermometer
Thermomètre digital
Termómetro digital

art.	div	range	col.
49880-13	0,1/1°C	-49,9+299,9°C	●
49880-14	0,1/1°C	-49,9+299,9°C	●
49880-15	0,1/1°C	-49,9+299,9°C	○
49880-17	0,1/1°C	-49,9+299,9°C	●

Sonda inox ø 3,3 x 110 mm. pieghevole a 180°.



Sous vide cooking thermometer

Termometro per sottovuoto
Vakuüm-Koch-Thermometer
Thermomètre pour cuisson sous-vide
Termómetro cocción al vacío

art.	div	range
49881-01	0,1°C	-99,9+299,9°C
	1°C	+300+1372°C

Kit: thermometer, Sous-Vide needle probe 60 mm., one metre foam/tape, zip pouch, free traceable certificate of calibration.

Kit: termometro, sonda per sottovuoto 60 mm., 1 metro di nastro adesivo, astuccio con zip, certificato di calibrazione tracciabile.



Sous vide cooking thermometer

Termometro per sottovuoto
Vakuüm-Koch-Thermometer
Thermomètre pour cuisson sous-vide
Termómetro cocción al vacío

art.	div	range
49881-11	0,1°C	-49,9+299,9°C

Dim. 1,9x4,7x15,3 cm. S/steel needle probe Ø 1,1 x 60 mm. FREE traceable certificate of calibration incl. – Sonda ad ago inox Ø 1,1 x 60 mm. Certificato di calibrazione incl.



Sous vide foam tape

Nastro adesivo per sottovuoto
Vakuümschaumklebeband
Ruban adhésif pour sous-vide
Cinta adhesiva para cocción al vacío

art.	l. cm.
49881-99	100

Used in conjunction with thermometer to measure the core temperature without suffering water ingress into vacuum sealed bag.

Utilizzato in combinazione con il termometro evita che penetri acqua nel sacchetto sotto vuoto.



Digital oven thermometer

Termometro digitale da forno
Ofen-Digitalthermometer
Thermomètre à four digital
Termómetro horno digital

art.	Ø cm.	div	range
49719-00	8	1°C/F	-50+300°C

Loud 70dB audible temperature alarm. 114 mm probe with 1,2 metre s/s braided lead that allows the probe to remain in the food during cooking. Water/dust resistance: IP65 protection.

Allarme acustico 70dB. Sonda 114 mm., cavo inox 1,2 metri che permette l'utilizzo durante la cottura. Resistenza acqua/polvere. IP65.



Waterproof digital timer

Timer digitale a tenuta stagna
Wasserdichte Digitaltimer
Timer digital étanche
Reloj digital impermeable

art.	Ø cm.	h.
49733-00	8	17

IP 65. 99M-99S. Dust and flour proof. Sound and flashing alarms. Hanging hook and suction cup. – A prova di polvere e farina. Suono e allarme lampeggiante. Gancio e ventosa.



Digital timer

Timer digitale
Digitalkochalarm
Minuterie digitale
Reloj digital

art.	cm.
49720-00	7x5,5

Timer 23H-59M-59S. Clock 12H AM/PM. Count down. 80dB audible alarm. Magnetic pad.
Orologio 12H AM/PM. Cronometro. Allarme acustico 80dB. Attacco magnetico.



Digital timer

Timer digitale
Digitalkochalarm
Minuterie digitale
Reloj digital

art.	cm.
49734-00	9x4,7x4,5

Count-down/up: 23H 59M 59S. 80 dB sound. 1 AAA battery.



Digital timer jumbo

Timer digitale gigante
Digitalkochalarm jumbo
Minuterie digitale géante
Reloj digital gigante

art.	cm.
49735-00	13,5x9,5x16

80dB sound. 4 programs. Electrical plug & battery. Waterproof front panel IP54.
Presa elettrica e batteria. Pannello frontale impermeabile IP54.



Thermohygrometer with clock

Termoigrometro con orologio
Thermohygrometer mit Uhr
Thermohygromètre avec horloge
Termohigrómetro con reloj

art.	cm.	range
49721-03	13x10x2,5	-20+50°C

10-99% RH - 12/24 H.



Syrup hydrometer

Densimetro per sciroppo
Sirup-Hydrometer
Hydromètre à sirop
Hidrómetro de jarabe

art.	l. cm.
49703-00	12,5

1100-1400 g/m - 15-40°Bé



Hydrometer for brine and salt

Densimetro per salamoia e sale
Hydrometer für Sole und Salz
Hydromètre à saumure et sel
Hidrómetro de salmuera y sal

art.	l. cm.
49730-20	19,5

1000-1250 g/m - 0-30°Bé



Salt tester and thermometer

Salinometro e termometro
Salzgehalt-Meter u. Thermometer
Testeur de salinité et thermometer
Salinómetro y termómetro

art.	cm.
49730-00	3,2x1,6x22,5

To measure the salt content of food and liquids in percentage from 0 to 5%. Temperature from 0°+100°C. – Per misurare il tenore di sale in alimenti e liquidi in percentuale da 0 a 5%. Temperatura da 0°+100° C.



Frying oil test strips

Strisce reattive per oli di frittura
Bratöl-Teststreifen
Bandes réactives pour les huiles de friture
Tiras reactivas para control aceites

art.

49731-99

Storage bottles of 100 Oil Quality Test Strips and easy to read colour chart. Hold the test strip in the oil for 2 seconds (max 40°C), then remove it and wait 2 minutes, next, compare the strip to the colour chart. – Flacone con 100 strisce reattive e tabella colori di facile lettura. Immergere la fascia colorata della striscia nell'olio (max. 40°C) per 2 secondi, quindi rimuoverla e attendere 2 minuti. Confrontare la striscia con la tabella colori.



Frying oil tester

Test degradazione oli di frittura
Kontrollsystem für Bratenöle
Test dégradation des huiles de friture
Test para control aceites

art.

49731-10

Consisting of two reagents that are not harmful to health and environmentally friendly. For 20 tests. ATTENTION: works with all types and brands of frying oil, (except with palm oil). – Composto da due reagenti non nocivi per la salute e rispettosi dell'ambiente. Per 20 test. ATTENZIONE: funziona con tutti i tipi e le marche di olio di frittura, (tranne che con l'olio di palma).



Labels solvable

Etichette dissolvibili
Lösbare Etiketten
Etiquettes solubles
Etiquetas solubles

art. cm. pcs/pz

44630-01 7,5x4 250

Dissolvable in less than 20 seconds. Suitable for any type of surface. – Dissolvibili in meno di 20 secondi. Adatte a qualsiasi tipo di superficie.



Labels 14 allergens

Etichette 14 allergeni
Etiketten 14 Allergene
Etiquettes 14 allergènes
Etiquetas 14 alergenos

art. cm. pcs/pz

44630-02 7,5x4 500

Labels with all 14 allergens pre-printed.
Etichette con i 14 allergeni prestampati.



Labels Express 7 days

Etichette express 7 giorni
Etiketten Express 7 Tage
Etiquettes express 7 jours
Etiquetas express 7 días

art. cm. pcs/pz

44630-03 3x2,5 1750

Different colors based on the day of the week. Data to be written: product description; date of production or expiry date. – Diversi colori in base al giorno della settimana. Dati da inserire: descrizione del prodotto; data di produzione o data di scadenza.



Labels frozen food

Etichette frozen/surgelati
Etiketten Tiefkühlkost
Etiquettes aliments surgelés
Etiquetas alimentos congelados

art. cm. pcs/pz

44630-04 7x4,5 500

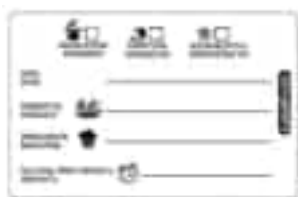

Labels TMC
Etichette TMC
Etiketten TMC
Etiquettes TMC
Etiquetas TMC

art.	cm.	pcs/pz
44630-05	7x4,5	300

TMC: Termine minimo di conservazione.

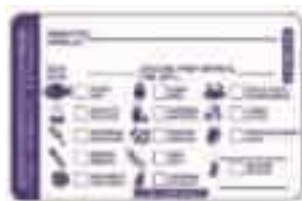

Labels Allergens
Etichette allergeni
Etiketten Allergene
Etiquettes allergènes
Etiquetas alérgenos

art.	cm.	pcs/pz
44630-06	7x4,5	500



Labels delivery with allergens
Etichette delivery con allergeni
Etiketten Lieferung mit Allergenen
Etiquettes livraison avec allergènes
Etiquetas entrega con alérgenos

art.	cm.	pcs/pz
44630-07	14x4,5	250



Wall clock
Orologio da parete
Wanduhr
Horloge à paroi
Reloj de pared

art.	Ø cm.
41380-01	26

Satin alloy. With hygrometer and thermometer.
Metallo satinato. Con igrometro e termometro.



Wall clock
Orologio da parete
Wanduhr
Horloge à paroi
Reloj de pared

art.	Ø cm.
41380-02	30,5

Silent clock. – Movimento silenzioso.



Digital spoon scale
Bilancia digitale a cucchiaino
Digitale Löffelwaage
Balance-cuillère numérique
Cuchara pesa numérica

art.	mm.	cap
49727-00	225x49x25	500g



Mechanical scale
Bilancia meccanica
Waage
Balance
Balanza

art.	Ø cm.	Kg.	div
49864-03	20	3	10g
49864-05	20	5	20g



Mechanical scale
Bilancia meccanica
Waage
Balance
Balanza

art.	Ø cm.	Kg.	div
49864-20	25	20	100g



Digital kitchen scale
Bilancia digitale da cucina
Digital-Küchenwaage
Balance de cuisine
Balanza digital de cocina

art.	cm.	Kg.	div
49773-05	21,5x13	5	1g



SS
ABS

Digital kitchen scale

Bilancia digitale da cucina
Digital-Küchenwaage
Balance de cuisine
Balanza digital de cocina

art.	cm.	Kg.	div
49774-05	22,5x16,5x2	5	1g



Pocket scale

Bilancia tascabile
Taschenwaage
Balance de poche
Balanza de bolsillo

art.	cm.	Kg.	div
49771-00	15x10x2,5	0,25	0,1 g



SS
ABS

Pocket scale

Bilancia tascabile
Taschenwaage
Balance de poche
Balanza de bolsillo

art.	cm.	Kg.	div
49772-01	12,7x7,6x2	1	0,1 g



SS
ABS

Electronic scale IP53

Bilancia elettronica
Elektronische Waage
Balance électronique
Balanza electrónica

art.	cm.	Kg.	div
49863-15	31x30x11,5	12	1g
49863-30	31x30x11,5	30	2g
49863-50	31x30x11,5	50	5g



ABS

Adapter for electronic scale

Adattatore per bilancia elettronica
Adapter für elektronische Waage
Adaptateur pour balance électronique
Adaptador para balanza electrónica

art.	cm.
49863-AA	16,5x4x7

Cable 1,5 mt. Not provided with scales. – Cavo 1,5 mt. Non fornito con le bilance.



ABS
SS

Digital scale IP44

Bilancia digitale
Digitalwaage
Balance digitale
Balanza digital

art.	cm.	Kg.	div
49775-05	24,5x31x9,5	5	1g
49775-10	24,5x31x9,5	10	1g



ABS
SS

Digital scale IP44

Bilancia digitale
Digitalwaage
Balance digitale
Balanza digital

art.	cm.	Kg.	div
49777-50	29x33,5x11	50	1g

Unit: Kg/lb.



SS

Digital scale IP67

Bilancia digitale
Digitalwaage
Balance digitale
Balanza digital

art.	cm.	Kg.	div
49776-15	24x29x11	15	1g
49776-30	24x29x11	30	2g



ABS
SS

Digital scale with platform IP54

Bilancia digitale con piattaforma
Digitalwaage mit Plattform
Balance digitale avec plate-forme
Balanza digital con plataforma

art.	cm.	Kg.	div
49779-15	50x40x84	150	20g
49779-30	60x50x84	300	50g

SERIES 18100

FORGED KNIVES
COLTELLI FORGIATI



A deep study and computerised tests of ergonomics, movement and posture have allowed Paderno to create a professional knives line, that is the synthesis of comfort and cutting precision. Handle made of plastic specially developed for the food processing sector, ergonomic design with soft edges, perfect grip to ensure precise guidance. The forged blade realised in special steel and molybdenum/vanadium, thanks to a peculiar hardening process, guarantees to the product a perfect cut and a long life of the blade's edge.

Uno studio approfondito e prove computerizzate di ergonomia, movimento e postura hanno permesso a Paderno di creare una linea di coltelli professionali, sintesi perfetta tra comfort e perfezione del taglio. Manico realizzato in speciale materiale plastico sviluppato per il settore alimentare, design ergonomico con bordi arrotondati, presa perfetta per garantire un taglio di precisione. Lama forgiata realizzata in lega di speciale acciaio, molibdeno e vanadio con particolare processo di tempra che garantisce al prodotto un ottimo taglio ed una perfetta e lunga tenuta di filo.



Cook's knife

Coltello cucina
Kochmesser
Couteau cuisine
Cuchillo de cocinero

art.	cm.
18100-16	16
18100-20	20
18100-24	24
18100-30	30
18100-36	36



Butcher's knife

Coltello francese
Blockmesser
Couteau de chef
Cuchillo de carnicero

art.	cm.
18102-16	16
18102-20	20
18102-26	26
18102-30	30



Oriental knife

Coltello orientale
Japanisches Kochmesser
Couteau de chef japonais
Cuchillo santoku

art.	cm.
18103-18	18



Oriental knife, scalloped edge

Coltello orientale, alveolato
Japanisches Kochmesser mit Kullenschliff
Couteau de chef japonais alveolé
Cuchillo santoku alveolato

art.	cm.
18104-18	18



Slicing knife

Coltello affettare
Fleischmesser
Tranchelard
Cuchillo trinchante

art.	cm.
18106-15	15
18106-20	20
18106-25	25
18106-30	30



Ham knife

Coltello prosciutto
Schinkenmesser
Trancheur à jambon
Cuchillo para jamón

art.	cm.
18109-26	26
18109-30	30



Ham knife, scalloped edge

Coltello prosciutto, alveolato
Schinkenmesser mit Kullenschliff
Couteau à jambon alvéolé
Cuchillo para jamón alveolato

art.	cm.
18110-26	26
18110-30	30
18110-36	36



Salmon knife

Coltello salmone
Lachsmesser
Couteau à saumon
Cuchillo para salmón

art.	cm.
18111-30	30



Salmon knife, scalloped edge

Coltello salmone, alveolato
Lachsmesser mit Kullenschliff
Couteau à saumon alvéolé
Cuchillo para salmón alveolato

art.	cm.
18112-30	30



Carving knife

Coltello trinciante
Tranchiermesser
Couteau à découper
Cuchillo trinchante

art.	cm.
18114-20	20



Filleting knife, flexible

Coltello filettare, flessibile
Filiermesser, flexibel
Couteau filet de sole, flexible
Cuchillo para filetear, flexible

art.	cm.
18115-20	20
18115-25	25



Boning knife

Coltello disosso
Ausbeinmesser
Couteau à désosser
Cuchillo deshuesador

art.	cm.
18116-14	14
18116-18	18



Steak knife serrated

Coltello bistecca seghettato
Steakmesser Wellenschliff
Couteau à steak dentelé
Cuchillo steak filo ondulado

art.	cm.
18122-12	12



Paring knife

Spelucchino
Spickmesser
Couteau d'office
Cuchillo mondador

art.	cm.
18124-09	9



Paring knife

Spelucchino
Spickmesser
Couteau d'office
Cuchillo mondador

art.	cm.
18125-07	7
18125-10	10



Bent paring knife

Coltello cuoco
Tourniermesser
Couteau bec d'oiseau
Cuchillo para pelar

art.	cm.
18126-07	7



Table knife serrated

Coltello tavola seghettato
Tafelmesser Wellenschliff
Couteau bout rond cranté
Cuchillo mesa filo ondulado

art.	cm.
18123-11	11



Bread knife

Coltello pane
Brotmesser
Couteau à pain
Cuchillo para pan

art.	cm.
18128-20	20
18128-24	24
18128-30	30



Meat fork

Forchettone
Fleischgabel
Fourchette baïonnette
Tenedor trinchante

art.	cm.
18230-13	13
18230-17	17



Carving fork

Forchettone curvo
Fleischgabel
Fourchette courbe
Tenedor trinchante

art.	cm.
18231-13	13

SERIES 18000

STAMPED KNIVES
COLTELLI TRANCIATI



The professional cutlery line "Color-Line" helps to reduce the risk of cross contamination using a Color Coding System which identifies each knife with a specific task: different food processing areas are easily identified. The steel used for this cutlery line has exceptional hardness and very high resistance to corrosion due to ICE-HARDENED system, a special process to harden the steel.

La linea di coltelleria professionale "CCS"– Color Coding System riduce i rischi di contaminazione incrociata grazie all'utilizzo di un Sistema di Codifica dei Colori che identifica ogni coltello per un uso specifico e permette di individuare facilmente le diverse aree di lavoro. Gli acciai utilizzati per questa linea di coltelleria presentano un'eccezionale durezza ed elevata resistenza alla corrosione, grazie all'uso del sistema ICE-HARDENING, processo speciale per temprare l'acciaio.



Cook's knife

Coltello cucina
Kochmesser
Couteau de cuisine
Cuchillo de cocinero

art.	cm.	col.
18000-16	16	●
18000-20	20	●
18000-23	23	●
18000-26	26	●
18000-30	30	●
18000-36	36	●



Cook's knife

Coltello cucina
Kochmesser
Couteau de cuisine
Cuchillo de cocinero

art.	cm.	col.
18000B16	16	●
18000B20	20	●
18000B23	23	●
18000B26	26	●
18000B30	30	●



Cook's knife

Coltello cucina
Kochmesser
Couteau de cuisine
Cuchillo de cocinero

art.	cm.	col.
18000G16	16	●
18000G20	20	●
18000G23	23	●
18000G26	26	●
18000G30	30	●



Cook's knife

Coltello cucina
Kochmesser
Couteau de cuisine
Cuchillo de cocinero

art.	cm.	col.
18000M16	16	●
18000M20	20	●
18000M23	23	●
18000M26	26	●



Cook's knife

Coltello cucina
Kochmesser
Couteau de cuisine
Cuchillo de cocinero

art.	cm.	col.
18000R16	16	●
18000R20	20	●
18000R23	23	●
18000R26	26	●
18000R30	30	●



Cook's knife

Coltello cucina
Kochmesser
Couteau de cuisine
Cuchillo de cocinero

art.	cm.	col.
18000W20	20	○
18000W26	26	○
18000W30	30	○



Cook's knife

Coltello cucina
Kochmesser
Couteau de cuisine
Cuchillo de cocinero

art.	cm.	col.
18000Y16	16	●
18000Y20	20	●
18000Y23	23	●
18000Y26	26	●



Slaughter/Butcher's knife

Coltello scimitarra
Schlacht U Fleischermesser
Couteau à découper
Cuchillo carnicero curvo

art.	cm.	col.
18005-22	22	●
18005-27	27	●
18005-32	32	●



Slaughter/Butcher's knife
Coltello scimitarra
Schlacht U Fleischermesser
Couteau à découper
Cuchillo carnicero curvo

art.	cm.	col.
18005B22	22	●
18005B27	27	●
18005B32	32	●



Slaughter/Butcher's knife
Coltello scimitarra
Schlacht U Fleischermesser
Couteau à découper
Cuchillo carnicero curvo

art.	cm.	col.
18005G22	22	●
18005G27	27	●
18005G32	32	●



Slaughter/Butcher's knife
Coltello scimitarra
Schlacht U Fleischermesser
Couteau à découper
Cuchillo carnicero curvo

art.	cm.	col.
18005R22	22	●
18005R27	27	●
18005R32	32	●



Slaughter/Butcher's knife
Coltello scimitarra
Schlacht U Fleischermesser
Couteau à découper
Cuchillo carnicero curvo

art.	cm.	col.
18005Y22	22	●
18005Y27	27	●
18005Y32	32	●



Butcher's knife
Coltello francese
Blockmesser
Couteau à découper
Cuchillo carnicero

art.	cm.	col.
18002-18	18	●
18002-20	20	●
18002-22	22	●
18002-26	26	●
18002-30	30	●
18002-36	36	●



Butcher's knife
Coltello francese
Blockmesser
Couteau à découper
Cuchillo carnicero

art.	cm.	col.
18002B26	26	●



Butcher's knife
Coltello francese
Blockmesser
Couteau à découper
Cuchillo carnicero

art.	cm.	col.
18002R18	18	●
18002R20	20	●
18002R22	22	●
18002R26	26	●
18002R30	30	●
18002R36	36	●



Butcher's knife
Coltello francese
Blockmesser
Couteau à découper
Cuchillo carnicero

art.	cm.	col.
18002Y18	18	●
18002Y26	26	●
18002Y30	30	●
18002Y36	36	●



Slicing knife

Coltello affettare
Wurstmesser
Couteau à trancher
Cuchillo trinchante

art.	cm.	col.
18006-20	20	●
18006-25	25	●
18006-30	30	●
18006-36	36	●



Slicing knife

Coltello affettare
Wurstmesser
Couteau à trancher
Cuchillo trinchante

art.	cm.	col.
18006B20	20	●
18006B25	25	●
18006B30	30	●



Slicing knife

Coltello affettare
Wurstmesser
Couteau à trancher
Cuchillo trinchante

art.	cm.	col.
18006G20	20	●
18006G25	25	●



Slicing knife

Coltello affettare
Wurstmesser
Couteau à trancher
Cuchillo trinchante

art.	cm.	col.
18006R25	25	●
18006R30	30	●



Slicing knife

Coltello affettare
Wurstmesser
Couteau à trancher
Cuchillo trinchante

art.	cm.	col.
18006Y20	20	●
18006Y25	25	●
18006Y30	30	●



Slicing knife, wavy blade

Coltello affettare, dentato
Wurstmesser mit Wellenschliff
Couteau à trancher dentelé
Cuchillo trinchante ondulado

art.	cm.	col.
18007-25	25	●
18007-30	30	●
18007-36	36	●



Slicing knife, wavy blade

Coltello affettare, dentato
Wurstmesser mit Wellenschliff
Couteau à trancher dentelé
Cuchillo trinchante ondulado

art.	cm.	col.
18007G30	30	●



Cook's knife

Coltello cucina
Kochmesser
Couteau de cuisine
Cuchillo de cocinero

art.	cm.	col.
18008-20	20	●
18008-26	26	●
18008-30	30	●
18008-36	36	●



Cook's knife

Coltello cucina
Kochmesser
Couteau de cuisine
Cuchillo de cocinero

art.	cm.	col.
18008B30	30	●



Cook's knife

Coltello cucina
Kochmesser
Couteau de cuisine
Cuchillo de cocinero

art.	cm.	col.
18008R26	26	●
18008R30	30	●
18008R36	36	●



Cook's knife

Coltello cucina
Kochmesser
Couteau de cuisine
Cuchillo de cocinero

art.	cm.	col.
18008Y30	30	●



Ham knife

Coltello prosciutto
Schinkenmesser
Trancheur à jambon
Cuchillo para jamón

art.	cm.	col.
18009-25	25	●
18009-30	30	●
18009-36	36	●



Ham knife

Coltello prosciutto
Schinkenmesser
Trancheur à jambon
Cuchillo para jamón

art.	cm.	col.
18009B25	25	●



Ham knife

Coltello prosciutto
Schinkenmesser
Trancheur à jambon
Cuchillo para jamón

art.	cm.	col.
18009R25	25	●



Ham knife

Coltello prosciutto
Schinkenmesser
Trancheur à jambon
Cuchillo para jamón

art.	cm.	col.
18009W25	25	○
18009W30	30	○



Ham knife

Coltello prosciutto
Schinkenmesser
Trancheur à jambon
Cuchillo para jamón

art.	cm.	col.
18009Y25	25	●
18009Y30	30	●



Salmon knife

Coltello salmone
Lachsmesser
Couteau à saumon
Cuchillo salmón

art.	cm.	col.
18011-32	32	●



Ham knife, scalloped edge

Coltello prosciutto, alveolato
Schinkenmesser mit Kullenschliff
Couteau à jambon alvéolé
Cuchillo para jamón alveolado

art.	cm.	col.
18010-25	25	●
18010-30	30	●
18010-36	36	●



Ham knife, scalloped edge

Coltello prosciutto, alveolato
Schinkenmesser mit Kullenschliff
Couteau à jambon alvéolé
Cuchillo para jamón alveolado

art.	cm.	col.
18010Y30	30	●



Salmon knife, scalloped edge

Coltello salmone, alveolato
Lachsmesser mit Kullenschliff
Couteau à saumon alvéolé
Cuchillo salmón alveolado

art.	cm.	col.
18012-32	32	●



Salmon knife, scalloped edge

Coltello salmone, alveolato
Lachsmesser mit Kullenschliff
Couteau à saumon alvéolé
Cuchillo salmón alveolado

art.	cm.	col.
18012B32	32	●



Cheese slicer

Coltello salati/formaggio
Universalmesser
Couteau universel
Cuchillo universal

art.	cm.	col.
18013-30	30	●
18013-36	36	●



Cheese slicer
Coltello salati/formaggio
Universalmesser
Couteau universel
Cuchillo universal

art.	cm.	col.
18013G36	36	●



Cheese slicer
Coltello salati/formaggio
Universalmesser
Couteau universel
Cuchillo universal

art.	cm.	col.
18013W30	30	○
18013W36	36	○



Filetting knife
Coltello filettare
Filiermesser
Couteau filet de sole
Cuchillo fileteador

art.	cm.	col.
18015-18	18	●
18015-22	22	●
18015-27	27	●



Filetting knife
Coltello filettare
Filiermesser
Couteau filet de sole
Cuchillo fileteador

art.	cm.	col.
18015B18	18	●
18015B22	22	●



Filetting knife
Coltello filettare
Filiermesser
Couteau filet de sole
Cuchillo fileteador

art.	cm.	col.
18015R22	22	●



Filetting knife
Coltello filettare
Filiermesser
Couteau filet de sole
Cuchillo fileteador

art.	cm.	col.
18015Y18	18	●
18015Y27	27	●



Boning knife
Coltello disosso
Ausbeinmesser
Couteau à désosser
Cuchillo deshuesador

art.	cm.	col.
18016-14	14	●
18016-16	16	●



Boning knife
Coltello disosso
Ausbeinmesser
Couteau à désosser
Cuchillo deshuesador

art.	cm.	col.
18016B14	14	●
18016B16	16	●



Boning knife
Coltello disosso
Ausbeinmesser
Couteau à désosser
Cuchillo deshuesador

art.	cm.	col.
18016R14	14	●
18016R16	16	●



Boning knife
Coltello disosso
Ausbeinmesser
Couteau à désosser
Cuchillo deshuesador

art.	cm.	col.
18016W16	16	○



Boning knife

Coltello disosso
Ausbeinmesser
Couteau à désosser
Cuchillo deshuesador

art.	cm.	col.
18016Y14	14	●
18016Y16	16	●



Boning knife

Coltello disosso Emilia
Ausbeinmesser
Couteau à désosser
Cuchillo deshuesador

art.	cm.	col.
18017-14	14	●
18017-16	16	●
18017-18	18	●



Boning knife

Coltello disosso Emilia
Ausbeinmesser
Couteau à désosser
Cuchillo deshuesador

art.	cm.	col.
18017B16	16	●
18017R16	16	●
18017Y16	16	●



Poultry sticking knife

Coltello scannapoli
Geflügelschlachtmesser
Couteau à volaille
Cuchillo deshuesador

art.	cm.	col.
18018-11	11	●
18018R11	11	●
18018Y11	11	●



Sticking knife

Coltello scannare
Stechmesser
Couteau à saigner
Cuchillo deshuesador

art.	cm.	col.
18019-12	12	●
18019-14	14	●
18019-16	16	●
18019-18	18	●
18019-20	20	●



Sticking knife

Coltello scannare
Stechmesser
Couteau à saigner
Cuchillo deshuesador

art.	cm.	col.
18019R12	12	●
18019R16	16	●
18019R20	20	●



Frozen food, two serrated edges

Coltello surgelati a doppia lama seghettata
Tiefkühlkost-Messer
Couteau à surgelés
Cuchillo de congelado

art.	cm.	col.
18020-23	23	●
18020B23	23	●
18020R23	23	●



Frozen food special serrated blade

Coltello surgelati lama seghettata speciale
Tiefkühlkost-Messer
Couteau à surgelés
Cuchillo de congelado

art.	cm.	col.
18021-18	18	●
18021B18	18	●
18021R18	18	●



Steak knife

Coltello bistecca
Steakmesser
Couteau à steak
Cuchillo para steak

art.	cm.	col.
18022-12	12	●



Table knife, half-waved

Coltello tavola, mezzo dentato
Tafelmesser halb gewellt
Couteau universel, demi-dentelée
Cuchillo mesa, medio dentado

art.	cm.	col.
18023-11	11	●



Steak/Pizza knife

Coltello bistecca/pizza
Steak-/Pizzamesser
Couteau à steak/pizza
Cuchillo para steak/pizza

art.	cm.	U. Pack	col.
18217-12	12	6	●



Paring knife

Spelucchino
Spickmesser
Couteau d'office
Cuchillo mondador

art.	cm.	col.
18024-08	8	●
18024-11	11	●



Paring knife

Spelucchino
Spickmesser
Couteau d'office
Cuchillo mondador

art.	cm.	col.
18024B08	8	●
18024B11	11	●



Paring knife

Spelucchino
Spickmesser
Couteau d'office
Cuchillo mondador

art.	cm.	col.
18024G08	8	●
18024G11	11	●



Paring knife

Spelucchino
Spickmesser
Couteau d'office
Cuchillo mondador

art.	cm.	col.
18024M08	8	●
18024M11	11	●



Paring knife

Spelucchino
Spickmesser
Couteau d'office
Cuchillo mondador

art.	cm.	col.
18024R08	8	●
18024R11	11	●



Paring knife

Spelucchino
Spickmesser
Couteau d'office
Cuchillo mondador

art.	cm.	col.
18024W08	8	○
18024W11	11	○



Paring knife

Spelucchino
Spickmesser
Couteau d'office
Cuchillo mondador

art.	cm.	col.
18024Y08	8	●



Bent paring knife

Coltello cuoco
Tourniermesser
Couteau bec d'oiseau
Cuchillo para pelar

art.	cm.	col.
18026-07	7	●
18026B07	7	●



Bent paring knife

Coltello cuoco
Tourniermesser
Couteau bec d'oiseau
Cuchillo para pelar

art.	cm.	col.
18026G07	7	●
18026M07	7	●



Confectioner's knife

Coltello pasticceria
Bäckmesser
Couteau de pâtissier
Cuchillo de pastelero

art.	cm.	col.
18029-25	25	●
18029-30	30	●
18029-36	36	●



Confectioner's knife

Coltello pasticceria
Bäckmesser
Couteau de pâtissier
Cuchillo de pastelero

art.	cm.	col.
18029W30	30	○
18029W36	36	○





Bread knife
Coltello pane
Brotmesser
Couteau à pain
Cuchillo para pan

art.	cm.	col.
18028-21	21	●



Bread knife
Coltello pane
Brotmesser
Couteau à pain
Cuchillo para pan

art.	cm.	col.
18028-25	25	●
18028-30	30	●
18028-36	36	●



Bread knife
Coltello pane
Brotmesser
Couteau à pain
Cuchillo para pan

art.	cm.	col.
18028B30	30	●



Bread knife
Coltello pane
Brotmesser
Couteau à pain
Cuchillo para pan

art.	cm.	col.
18028M25	25	●



Bread knife
Coltello pane
Brotmesser
Couteau à pain
Cuchillo para pan

art.	cm.	col.
18028W21	21	○
18028W25	25	○
18028W30	30	○
18028W36	36	○



Bread knife
Coltello pane
Brotmesser
Couteau à pain
Cuchillo para pan

art.	cm.	col.
18028Y25	25	●
18028Y30	30	●



Pastry knife
Coltello dolce
Bäckermesser
Couteau de pâtissier
Cuchillo de pastelero

art.	cm.	col.
18030-26	26	●
18030-31	31	●
18030-36	36	●



Pastry knife
Coltello dolce
Bäckermesser
Couteau de pâtissier
Cuchillo de pastelero

art.	cm.	col.
18030W26	26	○
18030W31	31	○
18030W36	36	○

SPECIAL ITEMS
PEZZI SPECIALI



Chinese meat cleaver
Falcetta cinese
Chinesishackmesser
Couteau de chef chinois
Macheta Chino

art.	cm.	col.
18221-17	17	●
18221-19	19	●
18221-21	21	●



Chinese meat cleaver
Falcetta cinese
Chinesishackmesser
Couteau de chef chinois
Macheta Chino

art.	cm.	col.
18221B17	17	●
18221B19	19	●
18221B21	21	●



Chinese meat cleaver
Falcetta cinese
Chinesishackmesser
Couteau de chef chinois
Macheta Chino

art.	cm.	col.
18221G17	17	●
18221G19	19	●
18221G21	21	●



Chinese meat cleaver
Falcetta cinese
Chinesishackmesser
Couteau de chef chinois
Macheta Chino

art.	cm.	col.
18221M17	17	●
18221M19	19	●
18221M21	21	●



Chinese meat cleaver

Falcetta cinese
Chinesishackmesser
Couteau de chef chinois
Macheta Chino

art.	cm.	col.
18221R17	17	●
18221R19	19	●
18221R21	21	●



Chinese meat cleaver

Falcetta cinese
Chinesishackmesser
Couteau de chef chinois
Macheta Chino

art.	cm.	col.
18221Y17	17	●
18221Y19	19	●
18221Y21	21	●



Meat cleaver

Falcetta macellaio
Hackmesser
Couperet
Macheta

art.	cm.	Kg.	col.
18220-18	18	0,55	●
18220-20	20	1,10	●
18220-22	22	1,30	●
18220-26	26	1,30	●



Meat cleaver

Falcetta macellaio
Hackmesser
Couperet
Macheta

art.	cm.	Kg.	col.
18220B18	18	0,55	●
18220B20	20	1,10	●
18220B22	22	1,30	●
18220B26	26	1,30	●



Meat cleaver

Falcetta macellaio
Hackmesser
Couperet
Macheta

art.	cm.	Kg.	col.
18220R18	18	0,55	●
18220R20	20	1,10	●
18220R22	22	1,30	●
18220R26	26	1,30	●

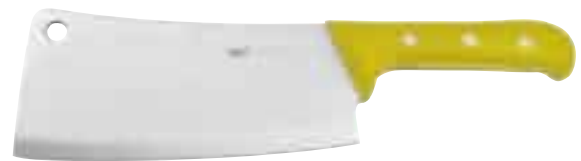

Meat cleaver

Falcetta macellaio
Hackmesser
Couperet
Macheta

art.	cm.	Kg.	col.
18220Y18	18	0,55	●
18220Y20	20	1,10	●
18220Y22	22	1,30	●
18220Y26	26	1,30	●



Heavy butcher's knife

Mezzo colpo
Kochschlagmesser
Couteau coup lourd
Cuchillo de carnicero

art.	cm.	Kg.	col.
18224-28	28	0,75	●
18224B28	28	0,75	●
18224R28	28	0,75	●
18224Y28	28	0,75	●



Heavy butcher's knife

Colpo
Kochschlagmesser
Couteau coup lourd
Cuchillo de carnicero

art.	cm.	Kg.	col.
18225-28	28	1	●
18225R28	28	1	●



Parmesan cheese knife

Coltello grana
Parmesanmesser
Couteau à Parmesan
Cuchillo Para Queso Parmenoso

art.	cm.	col.
18205-10	10	●



Parmesan cheese knife

Coltello grana
Parmesanmesser
Couteau à Parmesan
Cuchillo Para Queso Parmenoso

art.	cm.	col.
18205-12	12	●



Parmesan cheese knife

Coltello segnaforme
Parmesanmesser
Couteau à Parmesan
Cuchillo Para Queso Parmenoso

art.	cm.	col.
18206-09	9	●



Parmesan cheese knife

Coltello lancia Milano
Parmesanmesser
Couteau à Parmesan
Cuchillo Para Queso Parmenoso

art.	cm.	col.
18207-15	15	●



Oyster knife

Coltello apriostriche
Austermesser
Couteau à huîtres
Cuchillo para ostras

art.	cm.	col.
18209-06	15	●



Cheese knife 2 handles

Coltello formaggio
Käsemesser
Couteau à fromage
Cuchillo para queso

art.	cm.	col.
18201-36	36	●



Vegetable knife

Coltello verdure
Gemüsemesser
Couteau à légumes
Cuchillo para verduras

art.	cm.	col.
18222-18	18	●



Ham boner

Cannula disosso prosciutti
Schinkenauslöser
Gouge à jambons
Cuchillo deshuesar jamón

art.	cm.	col.
48021-21	21	●



Cheese knife

Coltello formaggio
Käsemesser
Couteau à fromage
Cuchillo para queso

art.	cm.	col.
18203-26	26	●



Baking pan knife

Coltello gastronomia
Winkelmesser
Couteau à angle
Cuchillo hoja angular

art.	cm.	col.
18215-13	13,5	●



Baking pan knife

Coltello gastronomia
Winkelmesser
Couteau à angle
Cuchillo hoja angular

art.	cm.	col.
18215-21	21,5	●



Pie knife

Coltello torta
Tortenmesser
Couteau à gâteau
Cuchillo para tartas

art.	cm.	col.
18514-18	18	●





Mincing knife

Mezzaluna
Wiegemesser
Hachoir
Media luna

art.	cm.	col.
48017-14	14	●
48017-25	26	●



Double blade mincing knife

Mezzaluna, lama doppia
Wiegemesser, Doppel-Klinge
Hachoir double lame
Media luna, doble

art.	cm.	col.
48215-14	14	●
48215-30	30	●



Meat fork

Forchettone
Fleischgabel
Fourchette baïonnette
Tenedor Trinchante

art.	cm.	col.
18226-17	17	●
18226B17	17	●
18226G17	17	●



Meat fork

Forchettone
Fleischgabel
Fourchette baïonnette
Tenedor Trinchante

art.	cm.	col.
18226R17	17	●
18226W17	17	○
18226Y17	17	●



Sharpening steel

Acciaino
Wetzstahl
Fusil
Chaira

art.	cm.	col.
18235-26	26	●



Sharpening steel

Acciaino
Wetzstahl
Fusil
Chaira

art.	cm.	col.
18235-30	30	●
18235B30	30	●
18235G30	30	●



Sharpening steel

Acciaino
Wetzstahl
Fusil
Chaira

art.	cm.	col.
18235R30	30	●
18235W30	30	○
18235Y30	30	●



Oval sharpening steel

Acciaino ovale
Wetzstahl, oval
Fusil ovale
Chaira ovalada

art.	cm.	col.
18236-30	30	●



Diamond sharpening steel

Acciaino diamantato
Diamant-Wetzstahl
Fusil diamant
Chaira adiamantada

art.	cm.	col.
18237-26	26	●



Sharpening stone GRIT 1000/240

Pietra per affilare
Abziehstein
Pierre à aiguiser
Piedra de afilar

art.	cm.
18251-01	21x7x3



Sharpening stone GRIT 1000/600

Pietra per affilare
Abziehstein
Pierre à aiguiser
Piedra de afilar

art.	cm.
18251-02	21x7x3



Poultry shears

Trinciapollo
Geflügelschere
Coupe-volailles
Tijeras aves

art.	cm.
18263-00	25



Poultry scissors, divisible

Forbice pollame, smontabile
Geflügelschere, teilbar
Coupe-volailles divisible
Tijeras aves, desmontables

art.	cm.
18275-00	26,5



Poultry shears, divisible

Trinciapollo, smontabile
Geflügelschere, teilbar
Coupe-volailles divisible
Tijeras aves, desmontables

art.	cm.
18261-00	24



Seafood scissors

Forbice gamberi
Meeresfrüchteschere
Ciseaux à crevettes
Tijeras camarones

art.	cm.
18278-00	18



Herb scissors, 5 blades

Forbice erbe, 5 lame
Kräuterschere 5 Klingen
Ciseaux à herbes 5 lames
Tijeras hierbas 5 Cuchillas

art.	cm.
18277-00	20



Salad scissors

Forbice insalata
Salatschere
Ciseaux à salade
Tijeras ensalada

art.	cm.
18270-22	22



Quail egg cutter

Forbice uova di quaglia
Wachteleierschere
Ciseaux oeufs de caille
Tijeras huevos de codorniz

art.	cm.
18279-14	14





All purpose scissors

Forbice multiuso
Küchenschere
Ciseaux de cuisine
Tijeras cocina

art.	cm.
18272-00	18,5



Kitchen scissors, divisible

Forbice cucina, smontabile
Küchenschere, teilbar
Ciseaux de cuisine, divisible
Tijeras cocina, desmontables

art.	cm.
18271-00	22,6



Kitchen scissors, divisible

Forbice cucina, smontabile
Küchenschere, teilbar
Ciseaux de cuisine, divisible
Tijeras cocina, desmontables

art.	cm.
18273-00	18

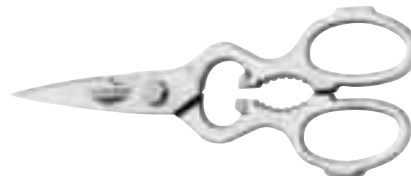

Kitchen scissors, divisible

Forbice cucina, smontabile
Küchenschere, teilbar
Ciseaux de cuisine, divisible
Tijeras cocina, desmontables

art.	cm.
18274-00	20

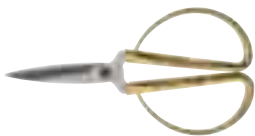

Chinese kitchen scissors

Forbice cinese cucina
Chinesische Küchenschere
Ciseaux chinois de cuisine
Tijeras chinas de cocina

art.	cm.
49636-00	17x8,5



Pizza scissors, divisible

Forbice pizza, smontabile
Pizzaschere, teilbar
Ciseaux à pizza, divisible
Tijeras pizza, desmontables

art.	cm.
18276-00	25

Stainless steel and brass. – Inox e ottone.



JAPANESE SUSHI KNIVES COLTELLI SUSHI GIAPPONESI

KNIVES
COLTELLERIA



Excellent choice when preparing sushi and vegetables. Molybdenum/Vanadium s/s blades for excellent edge retention, razor sharp edges, slip resistant wooden handles. The blades are sharpened with the traditional Japanese single bevel to improve sharpness. The large beveled one-sided edge is much thinner than a two-sided edge. This thinner, sharper edge makes for cleaner cuts through the soft flesh of fish, in particular. Using these knives will avoid bruising the delicate texture of raw fish and destroying the freshness of the fish. The thinner edge is more fragile than the edge on western knives. Do not use for cutting anything solid including larger fish bones. Due to the special blade sharpening and s/s used we highly recommend to only hand wash and dry the blades thoroughly immediately.

Una scelta eccellente per la preparazione di sushi e verdure. Lame in acciaio inox, molibdeno e vanadio, per un'ottimale tenuta del filo, affilatura a rasoio, manici in legno antiscivolo. Secondo la tradizione giapponese l'affilatura è unilaterale ed il filo è molto più sottile rispetto a quello della normale affilatura dei coltelli occidentali. Questo rende i tagli più nitidi ed evita di creare traumi alla trama delicata di carne e pesce crudo. Non utilizzare per il taglio di solidi incluse grosse lisce di pesce. Data la particolarità dell'affilatura e dell'acciaio impiegato si consiglia vivamente di lavare a mano ed asciugare immediatamente con cura le lame.



DEBA

art.	l. cm.
18280-22	22,5
18280-16	16,5
18280-10	10,5

The Deba is a powerful knife used for filleting fish and butchering meat without bones. Its weight and thickness can chop through fish bones and the sharp edge can fillet even the smallest of fish. – Affilato e dalla lama pesante usato per disossare e tagliare il pesce utilizzato nel sushi. È simile ad un coltello da chef.



OROSHI

art.	l. cm.
18281-24	24

An Oroshi Knife is a Japanese all-purpose cooking knife, but used particularly for fish. – Per sfilettare il tonno e altri pesci di grandi dimensioni.



USUBA

art.	l. cm.
18282-22	22,5
18282-18	18,0
18282-19*	18,0

***Double bevel. The Usuba is the ultimate vegetable knife. Sharp and thin, it is used by chefs in Japan for katsuramuki, a traditional style of peeling vegetables into thin sheets.** – *Doppia affilatura. Coltello estremamente affilato con una punta quadrata. Questo coltello è usato per tagliare verdure e quando è tenuto ben affilato può tagliarle in fette sottili come un foglio di carta.



TAKO SASHIMI

art.	l. cm.
18283-33	33
18283-27	27

The Tako Sashimi is a variation of the Yanagi and is used to slice straight-cut sashimi. The blunt tip and balanced weight works well on difficult ingredients like octopus, from which it gets its name. Originated in Kanto (Tokyo) region. – Il coltello Tako Sashimi assomiglia di più ad un coltello occidentale ed è utilizzato per affettare tagli spessi di carne per sushi. Ha la lama senza punta, per evitare di rovinare i tentacoli del polpo.



YANAGI SASHIMI

art.	l. cm.
18284-21	21
18284-27	27
18284-30	30
18284-33	33

The Yanagi Sashimi is a slicing knife used to cut boneless fish fillets into sashimi and topping for sushi. The graceful, thin blade cuts beautiful slices in one long, drawing stroke. Originated in Kansai (Osaka) region. – Viene utilizzato per tagliare sottili fette di verdure, carne o pesce, nonché per tagliare in generale a dadi o a fette. Grazie alla sua lama sottile ed affilata è utilizzato anche per creare guarnizioni o tagliare i rotoli di sushi.



Knife case, 14 pieces
Valigia cuoco, 14 pz.
Messerkoffer, 14 Stk.
Mallette de chef, 14 pièces
Maleta cuchillos, 14 piezas

art.	des.
18099-15	Comprende/includes:
18000-26	cook's knife/cucina cm 26
18000-30	cook's knife/cucina cm 30
18002-18	butcher's knife/francese cm 18
18002-26	butcher's knife/francese cm 26
18009-30	ham/prosciutto cm 30
18016-16	boning/disosso cm 6
18024-11	paring/spelucchino cm 11
18026-07	paring/spelucchino cm 7
18028-30	bread/pane cm 30
18230-17	fork/forchettone cm 17
18235-30	sharpener/acciaino cm 30
18519-26	spatula/spatola cm 26
48280-34	peeler/pelapatate
18276-00	scissors/forbice pizza

Knife case, 19 pcs
Valigia cuoco, 19 pz.
Messerkoffer, 19 Stk.,
Mallette de chef, 19 pcs
Maleta cuchillos, 19 piezas

art.	des.
18199-19	Comprende/includes:
18100-24	cook's knife/cucina cm 24
18100-30	cook's knife/cucina cm 30
18112-30	salmon/salmone cm 30
18115-20	filleting/filettare cm 20
18116-14	boning/disosso cm 14
18125-10	paring/spelucchino cm 10
18126-07	bent paring/spelucchino cm 7
18128-30	bread/pane cm 30
18230-17	fork/forchettone cm 17
18235-30	sharpener/acciaino cm 30
18276-00	scissors/forbice pizza
18255-00	sharpener/affila coltelli
48280-25	apple corer/levatorsoli
48280-34	peeler/pelapatate
48280-02	can opener/apribottiglie
48280-27	melon baller/scavino
48280-92	striper/decora limoni
48280-96	orange peeler/pelarence
48286-67	double melon baller/scavino doppio mm 22-30



Manual sharpener
Affilacoltelli manuale
Messer Schleifapparat
Affûteur manuel
Afilador manual

art.	cm.
18255-00	25



Manual sharpener
Affilacoltelli manuale
Messer Schleifapparat
Affûteur manuel
Afilador manual

art.	cm.
49739-00	14,5x7x1,5

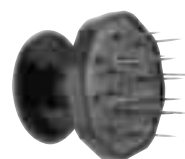

Salami pricker
Pungisalame
Salamistachel
Pique saucisson
Picadura para embutido

art.	Ø cm.
42523-00	7



Knife roll-bag, 9 pieces forged

Rotolo portacoltelli, 9 pz. forgiati
Messer-Rolltasche, 9-teilig
Rouleau pour couteaux, 9 pièces
Estuche cuchillos, 9 piezas

art.	des.
18190-09	Comprende/includes:
18116-14	boning/disosso cm 9
18100-24	cook's/cucina cm 24
18106-25	slicer/affettare cm 25
18109-26	ham/prosciutto cm 24



art.	des.
18124-09	paring/spelucchino
18128-24	bread/pane cm 14
18230-17	fork/forchettone
18235-26	sharpener/acciaino
18271-00	scissors/forbice



W

Knife block, 9 pcs set

Ceppo portacoltelli, set 9 pz
Messerblock, 9-tlg.
Bloc à couteaux, set 9 pièces
Bloque portacuchillos, 9 piezas

art.	des.
18192-09	Comprende/includes:
18100-20	cook's/cucina cm 20
18106-20	slicer/affettare cm 20
18124-09	paring/spelucchino cm 9
18128-20	bread/pane cm 20



art.	des.
18230-17	fork/forchettone cm 17
18235-26	sharpener/acciaino cm 26
18271-00	scissors/forbice
18102-16	butcher's/francese cm 16
18126-07	paring/cuoco cm 7



Magnetic knife rack

Barra magnetica
Magnet-Messerhalter
Porte-couteaux magnet
Barra magnética portas cuchillos

art.	cm.
48032-30	30
48032-45	45
48032-60	60



SS

Edlund

Knife block

Ceppo porta coltelli
Messerblock
Bloc à couteaux
Bloque portacuchillos

art.	cm.
49875-06	26x14x33



SS

Edlund

Knife rack

Porta coltelli
Messeraufhänger
Support à couteaux
Porta cuchillos

art.	cm.
48040-00	30,5x6,6x30,5

Holds 8 chef 's knives, 2 smaller knives, 1 steel and scissors. – Per 8 coltelli cuoco, 2 coltelli piccoli, 1 acciaio e forbici.



Knife rack

Porta coltelli
Messeraufhänger
Support à couteaux
Porta cuchillos

art. cm.
48040-10 30,5x6,6x35,6

Holds 8 chef 's knives, 2 smaller knives, 1 steel and scissors. – Per 8 coltelli cuoco, 2 coltelli piccoli, 1 acciaino e forbici.



Knife rack

Porta coltelli
Messeraufhänger
Support à couteaux
Porta cuchillos

art. cm.
48039-06 15,2x6,6x30,5

Holds 1 cleaver and 4 chef knives or 6 chef knives or 8 slicers or 12 paring knives and 1 round or diamond steel. – Per 1 mannaia e 4 coltelli cuoco o 6 coltelli cuoco o 8 coltelli affettare o 12 spelucchini e 1 acciaino tondo.



Knife sanitizing system

Sterilizzatore ad immersione
Messerentkeimer
Stérilisateur à couteaux
Esterilizador a inmersión

art. cm.
48040-50 45,7x11,5x45,7



Larding needle with flap

Ago lardellare con becco
Spicknadel mit Klappe
Lardoire à clapet
Aguja para mechar

art. Ø mm. cm.
42514-20 5 20



Trussing needle straight

Ago da cucina
Dressiernadel
Aiguille à brider droite
Aguja para bridar

art. cm.
42515-18 18
42515-20 20



Trussing needle bent

Ago da cucina curvo
Dressiernadel gebogen
Aiguille à brider courbe
Aguja curva para bridar

art. cm.
42516-18 18
42516-20 20



Needles 5 pcs set

Aghi set 5 pz
Nadelsatz, 5 Stk.
Aiguilles set 5 pcs
Agujas 5 pz

art.
42517-06



Skewers, 100 pcs

Spiedini, 100 pz
Fleischspieße, 100 Stk
Brochettes, 100 pcs
Palos para asar, 100 pz

art. cm.
48307-01 15
48307-02 20
48307-03 25



Skewers 6 pcs set

Spiedini set 6 pz
Fleischspieße, Satz 6 Stk
Brochettes set 6 pcs
Palos para asar 6 pz

art. cm.
42529-06 30



Skewers flat, 18/8

Spiedini piatti, 18/8
Fleischspieße, flach, 18/8
Brochettes plates, 18/8
Pinchos planos, 18/8

art.	mm.	U. Pack
42511-20	200x3	10
42511-25	250x3	10
42511-30	300x3	10
42511-35	350x3	10
42511-40	400x3	10
42511-56	560x5	10



Swords, 18/8

Spade, 18/8
Schwerter, 18/8
Epées, 18/8
Espadas, 18/8

art.	mm.
42511-60	600x15x3
42511-70	700x15x3

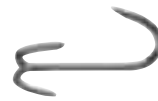

SS

Anchor meat hook

Gancio ad ancora
Anker Fleischhaken
Esse à ancre
Gancho forma ancla

art.	Ø mm.	cm.	U. Pack
42507-12	7	13	10



SS

Sliding meat hook

Gancio girevole
Fleischdrehhaken
Esse-tournante
Gancho giratorio

art.	Ø mm.	cm.	U. Pack
42525-27	12	27	10



SS

Meat hook, 2 peaks

Gancio fisso, 2 punte
Fleischhaken, 2 Spitze
Crochet esse, 2 pointes
Gancho 2 puntas

art.	Ø mm.	cm.	U. Pack
42524-06	3	6	10
42524-08	4	8	10
42524-10	4	10	10
42524-12	5	12	10
42524-14	5	14	10
42524-16	6	16	10
42524-18	6	18	10
42524-20	9	20	10
42524-22	9	22	10
42524-30	12	30	10



SS

Meat hook, 1 peak

Gancio fisso, 1 punta
Fleischhaken, 1 Spitze
Crochet esse, 1 pointe
Gancho 1 punta

art.	Ø mm.	cm.	U. Pack
42506-08	3	8	10
42506-10	4	10	10
42506-12	5	12	10
42506-14	5	14	10
42506-16	6	16	10
42506-18	6	18	10



SS

Swivel meat hook

Gancio girevole
Fleischdrehhaken
Esse-tournante
Gancho giratorio

art.	Ø mm.	cm.
42505-21	9	22
42505-24	10	24
42505-27	12	27
42505-50	12	50



SS

Sliding meat hook

Gancio scorrevole
Fleischhaken
Crochet coulissant
Gancho

art.	Ø mm.	cm.	U. Pack
42526-12	9	12	10
42526-14	12	14	10



SS

Ham tongs

Pinza per affettati
Schinkenlange
Pince à jambon
Pinza para jamón

art.	cm.
42510-00	11x6



SS

Meat tenderizer
Batticarne a pugno
Kotelettklopfen
Aplatisseur
Aplasta carnes

art.	Kg.
42501-15	1,5
42501-20	2,0



SS

Meat tenderizer
Batticarne a due tagli
Kotelettklopfen
Aplatisseur
Aplasta carnes

art.	Kg.
42502-11	1,1



SS

Meat tenderizer
Batticarne a paletta
Kotelettklopfen
Aplatisseur
Aplasta carnes

art.	Kg.
42503-10	1



Steak hammer, aluminum
Batticarne, alluminio
Aluminum-Fleischklopfen
Attendrisseur, alu
Aplasta carnes, aluminio

art.	cm.	Kg.
42508-00	32	0,6



Steak hammer, aluminum
Batticarne, alluminio
Aluminum-Fleischklopfen
Attendrisseur, alu
Aplasta carnes, aluminio

art.	cm.	Kg.
42508-01	25	0,41



SS

Bone-saw
Sega per ossa
Knochensäge
Scie à os
Sierra de cocina

art.	cm.
48231-40	40
48231-45	45
48231-50	50



SS

String holder
Portaspago
Schnurrolle-Halter
Porte rolls sur socle
Porta cuerda

art.	cm.
42579-00	19x12x17



SS

Meat pan
Vassoio rettangolare
Fleischblech
Plat boucher
Bandeja rectangular

art.	cm.
42534-26	26x23x2
42534-32	34x21x2
42534-41	45x25x2



SS

Display tray
Vassoio espositore
Ausstellplatte
Plateau
Bandeja expositora

art.	cm.
42532-29	29x21x2
42532-58	58x21x2



SS

Meat pan
Vassoio
Fleischblech
Plat boucher
Contenedor

art.	cm.
42530-26	24,4x21,6x5,5
42530-32	32x23x5,5
42530-41	41x31x5,5
42530-50	50x35x5,5



SS

Meat pan with grid
Vassoio con griglia
Fleischblech mit Siebeinsatz
Plat boucher avec grille
Contenedor con rejilla

art.	cm.
42531-26	24,4x21,6x5,5
42531-32	32x23x5,5
42531-41	41x31x5,5
42531-50	50x35x5,5



Ham stand on wood
Ferma prosciutto base legno
Schinkenhalter, Holzsockel
Pince à jambon sur bois
Jamonero, base madera

art.	cm.	Kg.
41582-00	24x45x16	4,5

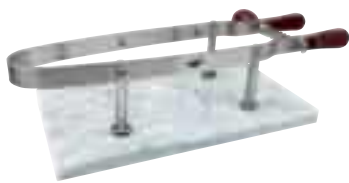

Ham stand on marble

Ferma prosciutto base marmo
Schinkenhalter, Marmorsockel
Pince à jambon sur marbre
Jamonero, base mármol

art.	cm.	Kg.
41583-00	24x45x15	10,3



SS

Hamburger press

Pressa-hamburger
Hamburgerpresse
Moule à steak
Prensa para hamburguesa

art.	Ø cm.	l. cm.
42864-10	10	36



Hamburger press, anodized aluminum

Pressa-hamburger, alluminio anodizzato
Hamburgerpresse, Aluminium eloxiert
Moule à steak, aluminium anodisé
Prensa para hamburguesa, aluminio anodizado

art.	cm.	Kg.
49978-10	37x25x50	5,0
49978-13	42x27,5x53	5,5

The parts coming into contact with food are in stainless steel. – Parti a contatto con il cibo in acciaio inox per alimenti.



Vertical manual sausage filler

Insaccatrice verticale
Wurstfüller
Poussoir manuel vertical
Enscadora vertical

art.	cm.	lt.	Kg.
49876-03	30x22x47,5	3	6,2

With 3 funnels. – Con 3 imbuti.



Manual slicing machine - Flywheel

Affettatrice manuale - Volano
Aufschnittmaschine - Schwungrad
Trancheuse manuelle - Volant
Cortadora manual - Volante

art.	Ø cm.	cm.	Kg.
49971-25	25	68x52x51	33

Cut thickness range mm 0÷2,3. 9 cutting positions. Cut cm 18,5x51. – Spessore taglio mm. 0÷2,3. 8 scatti. Taglio utile cm 18,5x15.



Manual slicing machine - Flywheel

Affettatrice manuale - Volano
Aufschnittmaschine - Schwungrad
Trancheuse manuelle - Volant
Cortadora manual - Volante

art.	Ø cm.	cm.	Kg.
49972-30	30	72x60x74	45,5

Cut thickness range mm 0÷2,5. 9 cutting positions. Cut cm 23x19. – Spessore taglio mm. 0÷2,5. 9 scatti. Taglio utile cm 23x19.



Manual slicing machine - Flywheel

Affettatrice manuale - Volano
Aufschnittmaschine - Schwungrad
Trancheuse manuelle - Volant
Cortadora manual - Volante

art.	Ø cm.	des.
49971R25	25	Rose
49971M25	25	Daisy
49972R30	30	Rose
49972M30	30	Daisy



Stand

Piedistallo
Sockel
Piédestal
Pedestal

art.	cm.
49971P25	65x80
49972P30	65x80



Stand with wheels

Piedistallo con ruote
Sockel mit Rädern
Piédestal avec roues
Pedestal con ruedas

art.	cm.
49971R00	65x80



Block brush, plastic handle
Spazzola per ceppa
Blockbürste, Kunststoffgriff
Brosse à billot, matière plastique
Cepillo para cepa

art. cm.
42518-01 20



PE

Cutting board with tray
Tagliere con vasca
Tranchierbrett mit Tablett
Planche à découper avec plateau
Tabla de corte con bandeja

art. cm.
44947-00 33,5x46x5,5

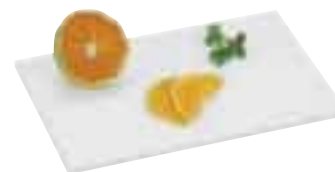

HDPE

Cutting board
Tagliere bar
Tranchierbrett
Planche à découper
Tabla de corte

art. cm.
42521-16 16x24,5x1
42521-24 24,5x32,5x1



HDPE

Cutting board
Tagliere bar
Tranchierbrett
Planche à découper
Tabla de corte

art.	cm.	GN	col.
42522-00	32x26,5x2	1/2	○
42522-01	32x26,5x2	1/2	●
42522-02	32x26,5x2	1/2	●
42522-03	32x26,5x2	1/2	●
42522-04	32x26,5x2	1/2	●
42522-05	32x26,5x2	1/2	●
42522-09	32x26,5x2	1/2	●



HDPE

Cutting board
Tagliere bar
Tranchierbrett
Planche à découper
Tabla de corte

art.	cm.	GN	col.
42538-00	53x32,5x2	1/1	○
42538-01	53x32,5x2	1/1	●
42538-02	53x32,5x2	1/1	●
42538-03	53x32,5x2	1/1	●
42538-04	53x32,5x2	1/1	●
42538-05	53x32,5x2	1/1	●
42538-09	53x32,5x2	1/1	●



HDPE

Cutting board
Tagliere bar
Tranchierbrett
Planche à découper
Tabla de corte

art.	cm.	col.
42539-00	60x40x2	○
42539-01	60x40x2	●
42539-02	60x40x2	●
42539-03	60x40x2	●
42539-04	60x40x2	●
42539-05	60x40x2	●
42539-09	60x40x2	●



HDPE

Cutting board
Tagliere bar
Tranchierbrett
Planche à découper
Tabla de corte

art.	cm.
42522-07	32x26,5x2
42538-07	53x32,5x2
42539-07	60x40x2



HDPE

Cutting board
Tagliere bar
Tranchierbrett
Planche à découper
Tabla de corte

art.	cm.
42537-40	40x30x2
42537-50	50x30x2
42537-80	80x40x2



HDPE

Cutting board with groove
Tagliere con canalina
Tranchierbrett mit Kanal
Planche à découper avec rigole
Tabla de corte con ranura

art.	cm.	GN	col.
42546-00	65x53x2	2/1	○
42546-01	65x53x2	2/1	●
42546-02	65x53x2	2/1	●
42546-03	65x53x2	2/1	●
42546-04	65x53x2	2/1	●
42546-05	65x53x2	2/1	●



HDPE

Cutting board with stoppers

Tagliere con fermi
Tranchierbrett mit Stiften
Planche à découper avec arrêts
Tabla de corte con barras de la parada

art.	cm.	GN	col.
42543-00	53x32,5x2	1/1	○
42543-01	53x32,5x2	1/1	●
42543-02	53x32,5x2	1/1	●
42543-03	53x32,5x2	1/1	●
42543-04	53x32,5x2	1/1	●
42543-05	53x32,5x2	1/1	●



HDPE

Cutting board with stoppers

Tagliere con fermi
Tranchierbrett mit Stiften
Planche à découper avec arrêts
Tabla de corte con barras de la parada

art.	cm.	col.
42544-00	60x40x2	○
42544-01	60x40x2	●
42544-02	60x40x2	●
42544-03	60x40x2	●
42544-04	60x40x2	●
42544-05	60x40x2	●



HDPE

Cutting board with stoppers

Tagliere con fermi
Tranchierbrett mit Stiften
Planche à découper avec arrêts
Tabla de corte con barras de la parada

art.	cm.
42540-40	40x30x2
42540-50	50x30x2
42540-80	80x40x2



NEW



Allergen safety utensils set

Set utensili sicurezza allergeni
Allergensicherheits-Werkzeugset
Ensemble d'ustensiles (allergènes)
Juego utensilios de seguridad para alérgenos

art.	cm.	Kg.
42528-00	58x41x10	4,76

Cutting board mm 305x457x13, chef's knife mm 254, s/s tongs and turner. – Tagliere mm 305x457x13, coltello cuoco mm 254, pinza e paletta inox.



HDPE

Colored cutting boards set 6 pcs

Taglieri colorati set 6 pz
Tranchierbretter 6 Stk.
Planches à découper set 6 pcs
Juego 6 tablas de corte

art.	cm.
42541-06	46x31x1,3



HDPE

Round cutting board

Tagliere tondo
Tranchierbrett, rund
Planche à découper, ronde
Tabla de corte redonda

art.	Ø cm.	h. cm.
42535-24	24,0	1,0
42535-32	32,5	1,5
42535-49	49,0	1,5



HDPE

Butchers table

Ceppa
Hackblock
Billot
Cepa

art.	cm.	mm.
42518-50	50x50x86	4*

*Thickness. – Spessore.

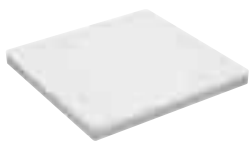

HDPE

Worktop

Ceppo
Arbeitsplatte
Plan de travail
Encimera

art.	cm.	mm.
42519-01	50x50	4*

*Thickness. – Spessore.



HDPE

Board scraper

Raschietto
Blockschäber
Racloir à planches
Rascador

art.	cm.
42520-00	17x6x9

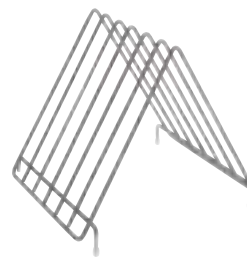

SS

Cutting board rack

Portataglieri in filo
Tranchierbretter-Träger
Sechoir à plaques à découper
Porta tablas

art.	cm.
42542-00	30x26x27,5



W

Bread cutting board

Tagliere pane
Brotschneidbrett
Planche à découper
Tabla de corte

art.	cm.
42964-53	53x32,5x2
42964-60	60x40x2



CE

SS

Chainmail glove

Guanto in cotta di maglia
Fingerhandschuhe
Gant en cotte de mailles
Guante de malla

art.	size/T.	col.
48505-01	S	○
48505-02	M	●
48505-03	L	●

UNI EN 1082-1:1998. Fits either hands, rings ø 4 mm. Thickness ø 0,5 mm. nylon strap.

Ambidestro, anelli ø 4 mm. Spessore ø 0,5 mm. cinturino nylon.



CE

SS

Chainmail glove, extended cuff

Guanto lungo in cotta di maglia
Fingerhandschuhe, lang
Gant en cotte de mailles, manchette longue
Guante largo de malla

art.	size/T.	col.
48506-01	S	○
48506-02	M	●
48506-03	L	●

UNI EN 1082-1:1998. Fits either hands, rings ø 4 mm. Thickness ø 0,5 mm. nylon strap.

Ambidestro, anelli ø 4 mm. Spessore ø 0,5 mm. cinturino nylon.



CE

SS

Protective apron

Grembiule di protezione
Schutzschürze
Tablier de protection
Delantal de protección

art.	cm.
48501-76	75x55

UNI EN 1082-1:1998. Belt fastening with textile adjustable and detachable straps. – Dotato di bretelle regolabili e staccabili.



Oven mitt

Guanto da forno
Ofenhandschuh
Moufle de déformement
Manopla de protección

art.	l. cm.
48510-00	28

Outer fabric 100% cotton with silver coating, 100 g/mq. – Tessuto esterno 100% cotone con rivestimento argenteo 100 g/mq.



Oven mitt, silicone

Guanto da forno, silicone
Backhandschuhe, Silikon
Gant de protection, silicone
Manopla de protección, silicona

art.
48514-00

Ambidextrous. Contact heat resistant up to +300°C for 15 seconds. Non-slip, water and oil tight, dishwasher safe. – Ambidestro. Resistenza al calore per contatto fino a 300°C per 15 secondi. Stagno all'acqua e agli oli bollenti, lavabile in lavastoviglie.



Cut resistant glove

Guanto antitaglio
Schnittschutz-Handschuh
Gant anti-coupures
Guante de protección

art.	l. cm.	size/T.
48523-01	22,0	S
48523-02	24,5	M
48523-03	27,0	L
48523-04	28,5	XL

HPPE yarn. Ambidextrous. Cut resistance Level 5. Suitable for contact with all types of food. Machine washable. – Filato HPPE. Guanti ambidestri. Resistenza al taglio Livello 5. Idonei al contatto con tutte le tipologie di alimenti. Lavabili in lavatrice.



NEW



Cut resistant glove

Guanto antitaglio
Schnittschutz-Handschuh
Gant anti-coupures
Guante de protección

art.	size/T.
48524-01	S
48524-02	M
48524-03	L

With exclusive antimicrobial agent. 10 gauge Dyneema fiber. Ambidextrous lightweight. Machine washable. Protection level A7 ANSI.
Con esclusivo agente antimicrobico. Fibra Dyneema calibro 10. Ambidestri leggeri. Lavabili in lavatrice. Livello di protezione A7 ANSI.



NEW

Oven mitt CoolTouch Flame

Guanto da forno
Ofenhandschuh
Moufle de déformement
Manopla de protección

art.	l. cm.
48507P38	38,1

Nomex, Kevlar seams. Heat and steam protection up to 280°C for 3 seconds. Ambidextrous. Machine washable. – Nomex, cuciture in Kevlar. Protezione dal calore e vapore fino a 280°C per 3 secondi. Ambidestro. Lavabile in lavatrice.



NEW

Oven mitt CoolTouch Flame

Guanto da forno
Ofenhandschuh
Moufle de déformement
Manopla de protección

art.	l. cm.
48507-43	43,2

Nomex, Kevlar seams. Heat and steam protection up to 280°C for 3 seconds. Ambidextrous. Machine washable. – Nomex, cuciture in Kevlar. Protezione dal calore e vapore fino a 280°C per 3 secondi. Ambidestro. Lavabile in lavatrice.



NEW

Oven mitt CoolTouch

Guanto da forno
Ofenhandschuh
Moufle de déformement
Manopla de protección

art.	l. cm.
48507-38	38,1

Polyester and cotton, Kevlar seams. Heat protection up to +260°C for 15 seconds. Ambidextrous. Machine washable. – Poliestere e cotone, cuciture in kevlar. Protezione dal calore fino a +260°C per 15 secondi. Ambidestro. Lavabile in lavatrice.



NEW

Oven mitt UltiGrips

Guanto da forno
Ofenhandschuh
Moufle de déformement
Manopla de protección

art.	l. cm.
48508-43	43,2

Neoprene, Kevlar seams. Contact heat resistant up to +260°C for 15 seconds. Ambidextrous. Machine washable. – Neoprene, cuciture in Kevlar. Resistente al calore da contatto fino a +260°C per 15 secondi. Ambidestro. Lavabile in lavatrice.



NEW

Oven mitt BestGrips

Guanto da forno
Ofenhandschuh
Moufle de déformement
Manopla de protección

art.	l. cm.
48509-43	43,2

Polyester and cotton. Non-slip neoprene gripp. Temperature protection from -23°C up to +260°C for 60 seconds. Ambidextrous. – Poliestere e cotone. Impugnatura antiscivolo in neoprene. Protezione termica da -23°C a +260°C per 60 secondi. Ambidestro.



NEW

Oven mitt BestGuard

Guanto da forno
Ofenhandschuh
Moufle de déformement
Manopla de protección

art.	l. cm.
48509-33	33

Polyester and cotton, Kevlar seams. Non-stick coating. Heat protection up to +232°C for 30 seconds. Ambidextrous. – Poliestere e cotone, cuciture in kevlar. Rivestimento antiaderente. Protezione dal calore fino a +232°C per 30 secondi. Ambidestro.



NEW

Oven mitt BestGuard

Guanto da forno
Ofenhandschuh
Moufle de déformement
Manopla de protección

art.	l. cm.
48509K43	43,2

Polyester and cotton, Kevlar seams. Non-stick coating. Heat protection up to +232°C for 30 seconds. Ambidextrous. – Poliestere e cotone, cuciture in kevlar. Rivestimento antiaderente. Protezione dal calore fino a +232°C per 30 secondi. Ambidestro.



Three-finger oven glove

Guanti anticalore a 3 dita
Backhandschuhe, 3 Finger
Moufles protection thermique, 3 doigts
Guantes de protección

art. l. cm.
48517-03 35,5

Resistant to abrasion, tears and cuts. CE marking, in accordance to the basic requirements concerning health and security of the European Directives 89/686/C.E.E. Contact heat resistant up to +350°C for 20 seconds. – Resistenti all'abrasione, agli strappi ed ai tagli. Marcati CE, rispettano i requisiti essenziali di salute e sicurezza secondo le direttive europee 89/686/C.E.E. Hanno una resistenza al calore per contatto fino a 350°C per 20 secondi.



Oven mitts

Guanti da forno
Backhandschuhe
Moufles de défournement
Manoplas de protección

art. cm.
48511-02 34x16

Special cotton fabric, natural color, reinforced palm and thumb. Heat resistant up to +200°C. Machine washable up to +40°C. – In cotone speciale, colore naturale, esecuzione rinforzata palmo e pollice. Resistente fino a +200°C. Lavabile in lavatrice max. 40°C.



Oven mitts

Guanti da forno
Backhandschuhe
Moufles de défournement
Manoplas de protección

art. cm.
48513-02 26x14,5

Special cotton fabric, natural color, reinforced palm and thumb. Heat resistant up to +200°C. Machine washable up to +40°C. – In cotone speciale, colore naturale, esecuzione rinforzata palmo e pollice. Resistente fino a +200°C. Lavabile in lavatrice max. 40°C.



Oven mitts

Guanti da forno
Backhandschuhe
Moufles de défournement
Manoplas de protección

art. cm.
48512-02 27x15

Special cotton fabric, natural color, reinforced palm and thumb. Heat resistant up to +200°C. Machine washable up to +40°C. – In cotone speciale, colore naturale, esecuzione rinforzata palmo e pollice. Resistente fino a +200°C. Lavabile in lavatrice max. 40°C.



Sugar gloves

Guanti in lattice
Zucker-Handschuhe
Gants à tirer le sucre
Guantes de látex

art. size/T.
48516-07 7 – 7 1/2
48516-08 8 – 8 1/2
48516-09 9 – 9/1/2



Disposable nitrile glove

Guanto monouso in nitrile
Einweghandschuh aus Nitril
Gant nitrile jetable
Guante de nitrilo desechable

art.	l. cm.	pcs/pz	size/T.
48519-01	24	100	S
48519-02	24	100	M
48519-03	24	100	L
48519-04	24	100	XL

Non-sterile, non-powder coated, with rolled edge. Textured on the fingertips. – Non sterili, senza rivestimento in polvere, con bordino arrotolato. Testurizzati sulla punta delle dita.



Scrubbing gloves

Guanti scrub
Schrubben Handschuhe
Gants à scrubbing
Guantes para fregar

art. size/T.
48518-01 one size



Scrubbing gloves

Guanti scrub
Schrubben Handschuhe
Gants à scrubbing
Guantes para fregar

art. size/T.
48518-02 one size



PASTRY PASTICCERIA

EQUIPMENT
ATTREZZATURE





Alphabet pcs 26

Alfabeto pz 26

art.	Ø cm.	h. cm.
47301-12	12	2



Numbers pcs 10

Numeri pz 10

art.	Ø cm.	h. cm.
47302-10	10	2

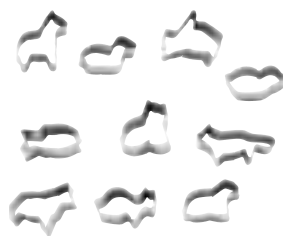

Animals pcs 10

Animali pz 10

art.	Ø cm.	h. cm.
47303-10	10	2

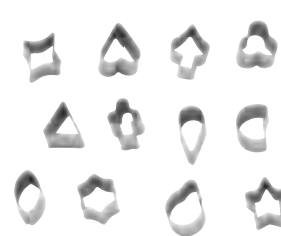

Shapes pcs 12

Sagome pz 12

art.	Ø cm.	h. cm.
47304-06	6,5	2

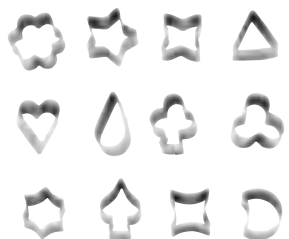

Shapes pcs 12

Sagome pz 12

art.	Ø cm.	h. cm.
47304-10	10	2



Shapes pcs 12

Sagome pz 12

art.	Ø cm.	h. cm.
47304-12	12	2



Shapes pcs 12

Sagome pz 12

art.	Ø cm.	h. cm.
47305-12	12	2



Flower pcs 6

Fiore pz 6

art.	Ø cm.	h. cm.
47306-10	10	3



Trio pcs 6

Trio pz 6

art.	Ø cm.	h. cm.
47307-10	10	3



Heart pcs 6

Cuore pz 6

art.	Ø cm.	h. cm.
47308-10	10	3



Star pcs 6

Stella pz 6

art.	Ø cm.	h. cm.
47310-10	10	3



Halfmoon pcs 6

Mezzaluna pz 6

art.	Ø cm.	h. cm.
47312-10	10	3



Hexagon pcs 6

Esagono pz 6

art.	Ø cm.	h. cm.
47314-10	10	3

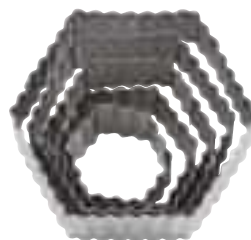

Hexagon, fluted pcs 5

Esagono festonato pz 5

art.	Ø cm.	h. cm.
47315-10	10	3,5



Ring pcs 11

Anello pz 11

art.	Ø cm.	h. cm.
47316-10	10	3



Ring pcs 14

Anello pz 14

art.	Ø cm.	h. cm.
47316-12	12	3



Ring pcs 20

Anello pz 20

art.	Ø cm.	h. cm.
47316-20	20	2,5



Ring, fluted pcs 11

Anello festonato pz 11

art.	Ø cm.	h. cm.
47317-10	10	3



Ring, fluted pcs 14

Anello festonato pz 14

art.	Ø cm.	h. cm.
47317-12	12	3





Drop pcs 6
Goccia pz 6

art.	Ø cm.	h. cm.
47321-12	12	3



Drop, fluted pcs 5
Goccia festonata pz 5

art.	Ø cm.	h. cm.
47322-12	12,5	3,5



Square pcs 6
Quadro pz 6

art.	Ø cm.	h. cm.
47323-12	12	3

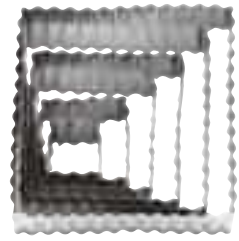

Square, fluted pcs 6
Quadro festonato pz 6

art.	Ø cm.	h. cm.
47324-12	12,5	3,5



Oval pcs 9
Ovale pz 9

art.	Ø cm.	h. cm.
47326-10	10	3,5

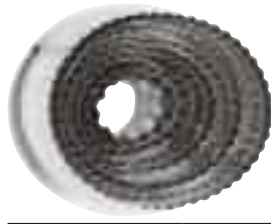

Oval, fluted pcs 9
Ovale festonato pz 9

art.	Ø cm.	h. cm.
47325-10	10	3,5



Oval, fluted pcs 6
Ovale festonato pz 6

art.	Ø cm.	h. cm.
12947-13	13	3,5

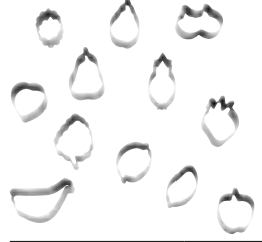

Fruit pcs 12
Frutta pz 12

art.	Ø cm.	h. cm.
47327-12	12,5	2



Animals pcs 10
Animali pz 10

art.	Ø cm.	h. cm.
47328-15	15	2



Vehicles pcs 7
Veicoli pz 7

art.	Ø cm.	h. cm.
47331-15	15	2



Vegetable pcs 12
Verdura pz 12

art.	Ø cm.	h. cm.
47332-12	12,5	2

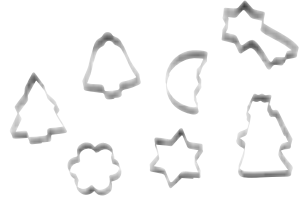

Christmas pcs 7
Natale pz 7

art.	Ø cm.	h. cm.
47333-15	15	2



Easter pcs 6
Pasqua pz 6

art.	Ø cm.	h. cm.
47334-12	12,5	2

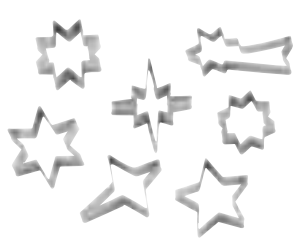

Stars pcs 7
Stelle pz 7

art.	Ø cm.	h. cm.
47335-12	12,5	2

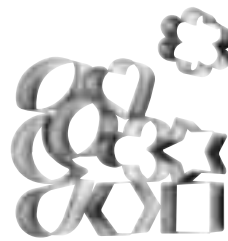

Shapes pcs 10
Sagome pz 10

art.	Ø cm.	h. cm.
47419-10	15	2



Shapes pcs 42
Sagome pz 42

art.	Ø cm.
47336-42	6>22



Plain ring pcs 3
Anello liscio pz 3

art.	Ø cm.	h. cm.
47414-03	6-7-8	3



Fluted ring pcs 3
Anello festonato pz 3

art.	Ø cm.	h. cm.
47415-03	6-7-8	3



Canestrello
Canestrello

art.	Ø cm.	h. cm.
47416-06	6	3



Canestrello, fluted
Canestrello festonato

art.	Ø cm.	h. cm.
47417-06	6	3

CHRISTMAS
NATALE



Gingerbread man
Omino pan di zenzero
art. cm.
47370-08 6x8x3



Angel
Angelo
art. cm.
47377-08 7x7x3



Snowman
Pupazzo di neve
art. cm.
47378-08 4x8x3



Reindeer
Renna
art. cm.
47379-08 8x7x3

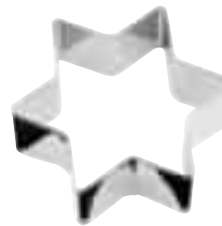

Star
Stella
art. cm.
47411-08 8x8x3

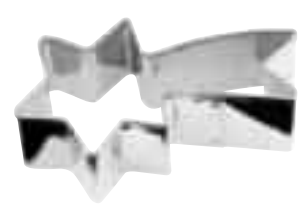

Comet
Stella cometa
art. cm.
47412-08 8x4x3



Christmas tree
Albero di Natale
art. cm.
47413-08 8x8x3



Pine
Pino
art. cm.
47413-01 6,4x8x3



Snowflake
Fiocco di neve
art. cm.
47411-01 7,4x8,6x3



Snowflake
Fiocco di neve
art. cm.
47411-02 7x8x3





Snowflake
Fiocco di neve

art. cm.
47411-03 8,5x8x3



Christmas, set of 6 pcs.
Natale set 6 pz

art. cm.
47387-01 8x8x3



EASTER
PASQUA



Rabbit
Coniglio

art. cm.
47372-08 8x4x3



Rabbit
Coniglio

art. cm.
47402-08 8x5x3



Rabbit
Coniglio

art. cm.
47402-01 7x8,5x3

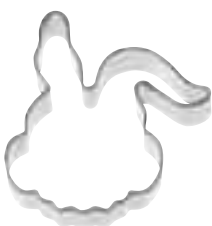

Rabbit
Coniglio

art. cm.
47402-02 7,5x7x3

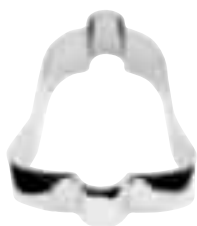

Bell
Campana

art. cm.
47373-08 6x7x3



Lamb
Agnellino

art. cm.
47376-08 8x7x3



Dove

Colomba

art. cm.
47382-08 8x7x3



Egg

Uovo

art. cm.
47373-01 5,6x8x3

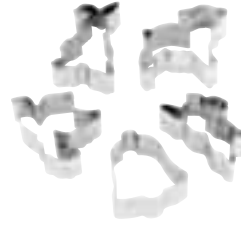

Easter, set of 5 pcs.

Pasqua set 5 pz

art. cm.
47387-02 8x8x3



HALLOWEEN



Skeleton

Scheletro

art. cm.
47370-08 6x8x3



Pumpkin

Zucca

art. cm.
47377-09 9x8x3



Pumpkin

Zucca

art. cm.
47377-10 8x8x3



Ghost

Fantasma

art. cm.
47377-03 8x8,4x3



Owl

Gufo

art. cm.
47377-02 4,7x8,3x3





Crescent
Mezzaluna

art. cm.
47377-01 6,2x8x3



Witch
Strega

art. cm.
47377-04 9x9,5x3

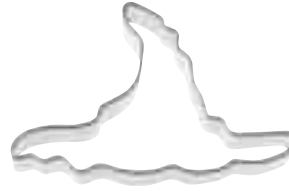

Witch hat
Cappello strega

art. cm.
47377-05 8,5x13x3



Witch on broom
Strega su scopa

art. cm.
47377-06 11,6x12x3



Halloween, set of 3 pcs.
Halloween set 3 pz

art. cm.
47377-11 11x10,7x2



ANIMALS & VARIOUS
ANIMALI & VARI



Honey bee
Ape

art. cm.
47382-06 11,6x8x3



Hippo
Ippopotamo

art. cm.
47404-04 11x7x3

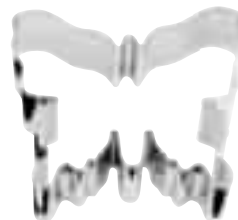

Butterfly
Farfalla

art. cm.
47371-08 8x7x3





Snail
Lumaca
art. cm.
47404-02 11x6x3

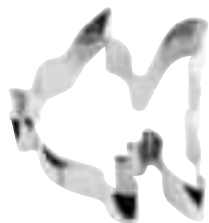

Fish
Pesce
art. cm.
47384-08 8x8x3



Frog
Rana
art. cm.
47380-08 8x8x3



Rooster
Gallo
art. cm.
47383-08 8x8x3



Dolphin
Delfino
art. cm.
47384-01 5x9x3



Seagull
Gabbiano
art. cm.
47386-08 11x6x3



Cat
Gatto
art. cm.
47401-08 8x8x3



Goose
Oca
art. cm.
47404-08 8x7x3



Teddy bear
Orsetto
art. cm.
47375-08 8x8x3



Camel
Cammello
art. cm.
47404-01 9x8,6x3



Teddy bear
Orsetto
art. cm.
47375-01 6x9x3



Elephant
Elefante
art. cm.
47404-03 12x7x3



Four leaf clover
Quadrifoglio
art. cm.
47374-08 8x8x3



Flower
Fiore
art. cm.
47374-02 7x7,4x3



Tulip
Tulipano
art. cm.
47374-01 5,5x8x3



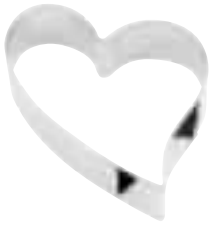

Heart

Cuore

art. cm.
47385-08 8x9x3

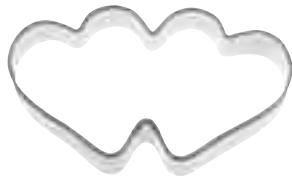

Two hearts

Due cuori

art. cm.
47385-01 9,4x5x3



Rocking horse

Cavallo a dondolo

art. cm.
47381-08 8x5x3



Bow

Fiocco

art. cm.
47373-02 6x8x3



Apple

Mela

art. cm.
47378-01 7,6x8,4x3



Airplane

Aereo

art. cm.
47370-02 9x8x3



Suits of cards, set of 4 pcs

Semi carte set 4 pz

art. cm.
47378-02 7,5x7,5x3



Numbers, set of 9 pcs

Numeri, set 9 pz

art. cm.
47421-09 6,5x2,5



Train

Locomotiva

art. cm.
47370-01 10x7x3



Pirate ship

Nave pirata

art. cm.
47370-03 8x8,4x3



Letters, set of 26 pcs

Lettere, set 26 pz

art. cm.
47422-26 6x2,5





Round, set 6 pcs
Cerchio, set 6 pz

art.	cm.
47425-01	4x3
47425-02	5x3
47425-03	6x3



Square, set 6 pcs
Quadro, set 6 pz

art.	cm.
47425-04	5x5x3
47425-05	6x6x3



Triangle, set 6 pcs
Triangolo, set 6 pz

art.	cm.
47425-06	6x3



Oval, set 6 pcs
Ovale, set 6 pz

art.	cm.
47425-09	7,5x4,5x3



Trapeze, set 6 pcs
Trapezio, set 6 pz

art.	cm.
47425-08	9x6x3



Rectangle, set 6 pcs
Rettangolo, set 6 pz

art.	cm.
47425-10	5x3,5x3
47425-11	6x5x3



Drop, set 6 pcs
Goccia, set 6 pz

art.	cm.
47425-26	9x3



Hexagon, set 6 pcs
Esagono, set 6 pz

art.	cm.
47425-29	5x3
47425-30	6x3



Heart, set 6 pcs
Cuore, set 6 pz

art.	cm.
47425-32	6,5x3



Square, set 6 pcs
Quadro, set 6 pz

art.	cm.
47426-01	8x8x4,5



Rectangle
Rettangolo

art.	cm.
47426-07	12x6x4,5



Doughnut cutter
Tagliapasta per doughnuts
Donut-Ausstecher
Coupe-donuts
Cortadonuts

art.	Ø cm.	h. cm.
47388-06	65-25	20
47388-07	70-30	17
47388-08	80-40	20



Cinnamon star cutter
Tagliapaste stelle
Zimtstern-Ausstecher
Coupe-étoiles
Cortapasta Esterella

art.	cm.
47377-15	5x9,7

Spring mechanism. – Meccanismo a molla.



Horseshoe, tin plate
Ferro di cavallo, banda stagnata
Hufeisen, Weißblech
Fer à cheval, fer blanc
Herradura, hojalata

art.	cm.
47377-12	7x6x2





Oval fluted cutter

Tagliapasta ovale festonato

Ausstecher, oval, gewellt

Découpoir ovale cannelé

Cortapasta ovalado acanalado

art.	Ø cm.	h. cm.
12947-02	5,5x3,5	3,5
12947-03	7x4	3,5
12947-04	8,5x5	3,5
12947-05	10x6	3,5
12947-06	11x7	3,5
12947-07	13x5	3,5

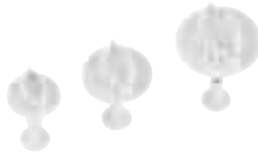

Dough plunger cutters w/extractor, 3 pcs

Tagliapasta con espulsore, set 3 pz

Ausstechformen mit Auswerfer, 3 Stk

Emportes-pièces, 3 pcs

Cortadores, 3 pz

art.	Ø cm.
47622-04	3x4,5

Holly. – Agrifoglio.

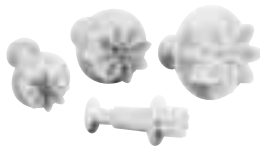

Dough plunger cutters w/extractor, 4 pcs

Tagliapasta con espulsore, set 4 pz

Ausstechformen mit Auswerfer, 4 Stk

Emportes-pièces, 4 pcs

Cortadores, 4 pz

art.	Ø cm.
47622-26	1,2 - 2 - 2,8 - 3,5

Daisy. – Margherita.

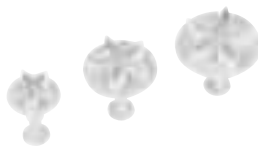

Dough plunger cutters w/extractor, 3 pcs

Tagliapasta con espulsore, set 3 pz

Ausstechformen mit Auswerfer, 3 Stk

Emportes-pièces, 3 pcs

Cortadores, 3 pz

art.	Ø cm.
47622-01	3x5

Petunie. – Petunia.



Dough plunger cutters w/extractor, 3 pcs

Tagliapasta con espulsore, set 3 pz

Ausstechformen mit Auswerfer, 3 Stk

Emportes-pièces, 3 pcs

Cortadores, 3 pz

art.	Ø cm.
47622-02	2,5

Flower. – Fiore.

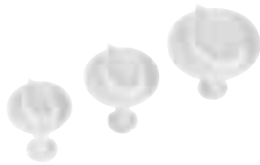

Dough plunger cutters w/extractor, 3 pcs

Tagliapasta con espulsore, set 3 pz

Ausstechformen mit Auswerfer, 3 Stk

Emportes-pièces, 3 pcs

Cortadores, 3 pz

art.	Ø cm.
47622-03	3x5

Rose leaf. – Foglia di rosa.



Set of 9 cutters

Set 9 tagliapasta

Satz 9 Ausstechformen

Set 9 découpoirs

Juego 9 cortadores

art.	h. cm.
47837-09	0,5

SS



Almond past knife

Coltello per marzapane

Marzipan-Messer

Couteau à pâte d'amande

Cuchillo para fondant/mazapán

art.	l. cm.
47630-28	16,5

PA



ABS

Modelling tool set

Kit attrezzi decoro

Modellierungswerkzeugsatz

Set d'outils à pâte d'amandes

Juego de utensilios para modelar

art.	l. cm.	pcs/pz
47631-12	16	14

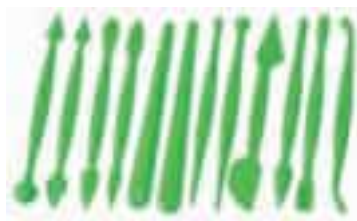

ABS

Modelling tool set

Kit attrezzi decoro

Modellierungswerkzeugsatz

Set d'outils à pâte d'amandes

Juego de utensilios para modelar

art.	l. cm.	pcs/pz
47631-08	16	12



SS

Set of 10 pcs dipping forks

Set 10 forchettine praliniera

Pralinen Gabelchen, 10 Stk.

Jeu de 10 ébauchois

Set de 10 herramientas para decorar chocolates

art.
47833-10



SS

Set of 4 pcs dipping forks

Set 4 forchettine pralineria

Pralinen Gabelchen, 4 Stk.

Jeu de 4 ébauchoirs

Set de 4 herramientas para decorar chocolates

art.

47833-04



SS

Set 2 decorating spoons

Set 2 cucchiari decorazione

Satz 2 Dekoration-Löffel

Set 2 cuillères pour décorer

2 cucharas para decoración

art. l. cm.

47831-02 18-20



STAINLESS STEEL NOZZLES
BOCCHETTE INOX



Set 12 pcs, one piece nozzles

Set 12 bocchette unipezzo

Tüllen Set 12 Stk. aus einem Stück gezogen

Set 12 pcs douilles monobloc

Surtido 12 boquillas monobloc

art.	Ø mm.	base Ø mm.
47357-20	1x 0,6-1,2-1,5-1,9-2,4-3 3,6-4,8-5,6-6,4-6,8-7,6	18



Set 9 pcs, one piece nozzles

Set 9 bocchette unipezzo

Tüllen Set 9 Stk. aus einem Stück gezogen

Set 9 pcs douilles monobloc

Surtido 9 boquillas monobloc

art.	base Ø mm.
47357-24	18



Set 7 pcs, one piece nozzles

Set 7 bocchette unipezzo

Tüllen Set 7 Stk. aus einem Stück gezogen

Set 7 pcs douilles monobloc

Surtido 7 boquillas monobloc

art.	Ø mm.	base Ø mm.
47357-21	1x 1,7-2,2-3,5-4,2-5-5,5-7	18



Set 8 pcs, one piece nozzles

Set 8 bocchette unipezzo

Tüllen Set 8 Stk. aus einem Stück gezogen

Set 8 pcs douilles monobloc

Surtido 8 boquillas monobloc

art.	Ø mm.	base Ø mm.
47357-22	1x 1-1,5-1,8-2,6-3-3,4-2,5-7	18





Set 8 pcs, one piece nozzles

Set 8 bocchette unipezzo

Tüllen Set 8 Stk. aus einem Stück gezogen

Set 8 pcs douilles monobloc

Surtido 8 boquillas monobloc

art. base ø mm.

47357-28 18



Set 8 pcs, one piece nozzles

Set 8 bocchette unipezzo

Tüllen Set 8 Stk. aus einem Stück gezogen

Set 8 pcs douilles monobloc

Surtido 8 boquillas monobloc

art. base ø mm.

47357-29 18



Set 8 pcs, one piece nozzles

Set 8 bocchette unipezzo

Tüllen Set 8 Stk. aus einem Stück gezogen

Set 8 pcs douilles monobloc

Surtido 8 boquillas monobloc

art. base ø mm.

47357-30 18



Set 8 pcs, one piece nozzles

Set 8 bocchette unipezzo

Tüllen Set 8 Stk. aus einem Stück gezogen

Set 8 pcs douilles monobloc

Surtido 8 boquillas monobloc

art. base ø mm.

47357-31 18



Set 6 pcs, one piece nozzles

Set 6 bocchette unipezzo

Tüllen Set 6 Stk. aus einem Stück gezogen

Set 6 pcs douilles monobloc

Surtido 6 boquillas monobloc

art. base ø mm.

47357-06 25



Set 6 pcs, one piece nozzles

Set 6 bocchette unipezzo

Tüllen Set 6 Stk. aus einem Stück gezogen

Set 6 pcs douilles monobloc

Surtido 6 boquillas monobloc

art. base ø mm.

47357-07 25



Set 6 pcs, one piece nozzles

Set 6 bocchette unipezzo
Tüllen Set 6 Stk. aus einem Stück gezogen
Set 6 pcs douilles monobloc
Surtido 6 boquillas monobloc

art. base ø mm.
47357-08 25

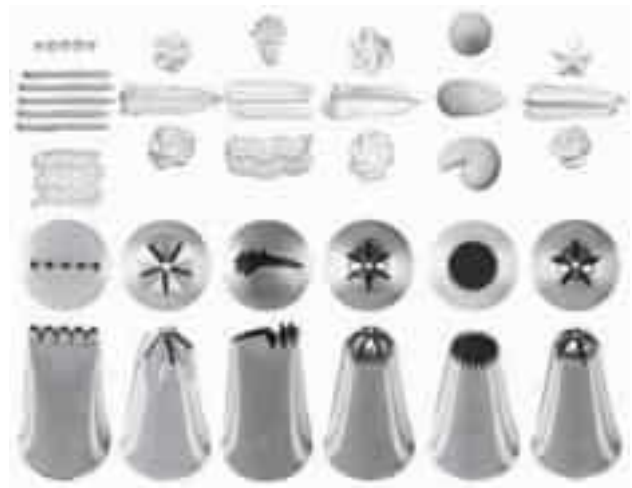

Set 6 pcs, one piece nozzles

Set 6 bocchette unipezzo
Tüllen Set 6 Stk. aus einem Stück gezogen
Set 6 pcs douilles monobloc
Surtido 6 boquillas monobloc

art. base ø mm.
47357-09 25



Set 6 pcs, one piece nozzles

Set 6 bocchette unipezzo
Tüllen Set 6 Stk. aus einem Stück gezogen
Set 6 pcs douilles monobloc
Surtido 6 boquillas monobloc

art. base ø mm.
47357-10 25



Set 6 pcs, one piece nozzles

Set 6 bocchette unipezzo
Tüllen Set 6 Stk. aus einem Stück gezogen
Set 6 pcs douilles monobloc
Surtido 6 boquillas monobloc

art. base ø mm.
47357-11 25



Set 4 pcs, one piece nozzles

Set 4 bocchette unipezzo
Tüllen Set 4 Stk. aus einem Stück gezogen
Set 4 pcs douilles monobloc
Surtido 4 boquillas monobloc

art. base ø mm.
47357-02 2x 31 - 2x 36



Set 7 pcs, one piece nozzles

Set 7 bocchette unipezzo
Tüllen Set 7 Stk. aus einem Stück gezogen
Set 7 pcs douilles monobloc
Surtido 7 boquillas monobloc

art. base ø mm.
47357-03 31





Set 3x2 nozzles

Set 3x2 bocchette

3x2 Stk. Tüllen

Set 3x2 pcs douilles

Juego 3x2 boquillas

art.	Ø mm.	stars
47350-01	2x 25	6
	2x 31	6
	2x 36	6



Set 3x2 nozzles

Set 3x2 bocchette

3x2 Stk. Tüllen

Set 3x2 pcs douilles

Juego 3x2 boquillas

art.	Ø mm.	stars
47351-01	2x 31	6
	2x 31	8
	2x 36	9



Set 3x2 nozzles

Set 3x2 bocchette

3x2 Stk. Tüllen

Set 3x2 pcs douilles

Juego 3x2 boquillas

art.	Ø mm.	stars
47352-01	2x 31	6
	2x 31	8
	2x 36	9

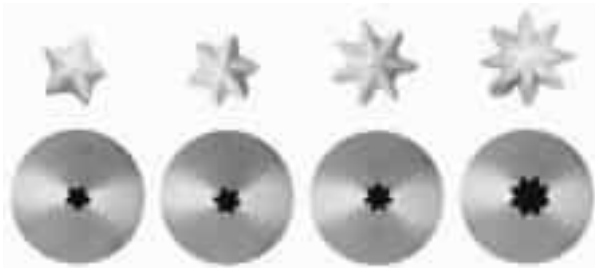

Set 6 pcs, one piece nozzles

Set 6 bocchette unipezzo

Tüllen Set 6 Stk. aus einem Stück gezogen

Set 6 pcs douilles monobloc

Surtido 6 boquillas monobloc

art.	Ø mm.	stars
47208-01	3,0	5
47208-02	3,0	6
47208-03	3,5	7
47208-04	5,0	8



Set 6 pcs, one piece nozzles

Set 6 bocchette unipezzo

Tüllen Set 6 Stk. aus einem Stück gezogen

Set 6 pcs douilles monobloc

Surtido 6 boquillas monobloc

art.	Ø mm.	stars
47208-05	5	5
47208-06	5	6
47208-07	6	7
47208-08	7	8



Set 6 pcs, one piece nozzles

Set 6 bocchette unipezzo

Tüllen Set 6 Stk. aus einem Stück gezogen

Set 6 pcs douilles monobloc

Surtido 6 boquillas monobloc

art.	Ø mm.	stars
47208-09	7	5
47208-10	7	6
47208-11	7	7
47208-12	9	8



Set 6 pcs, one piece nozzles

Set 6 bocchette unipezzo

Tüllen Set 6 Stk. aus einem Stück gezogen

Set 6 pcs douilles monobloc

Surtido 6 boquillas monobloc

art.	Ø mm.	stars
47208-13	11	5
47208-14	11	6
47208-15	11	7
47208-16	11	8



Set 6 pcs, one piece nozzles

Set 6 bocchette unipezzo

Tüllen Set 6 Stk. aus einem Stück gezogen

Set 6 pcs douilles monobloc

Surtido 6 boquillas monobloc

art.	Ø mm.	stars
47208-17	13	5
47208-18	13	6
47208-19	13	7
47208-20	13	8

Set 6 pcs, one piece nozzles

Set 6 bocchette unipezzo

Tüllen Set 6 Stk. aus einem Stück gezogen

Set 6 pcs douilles monobloc

Surtido 6 boquillas monobloc

art.	Ø mm.	stars
47208-21	18	5
47208-22	18	6
47208-23	18	7
47208-24	18	8

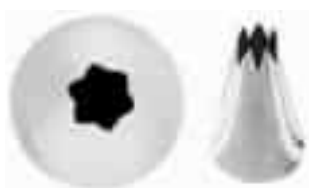

Set 6 pcs, one piece nozzles

Set 6 bocchette unipezzo

Tüllen Set 6 Stk. aus einem Stück gezogen

Set 6 pcs douilles monobloc

Surtido 6 boquillas monobloc

art.	Ø mm.	stars
47354-02	2	6
47354-04	4	6
47354-06	6	6
47354-08	8	6
47354-10	10	6
47354-12	12	7
47354-14	14	8
47354-16	16	9
47354-18	18	10

Set 6 pcs, one piece nozzles

Set 6 bocchette unipezzo

Tüllen Set 6 Stk. aus einem Stück gezogen

Set 6 pcs douilles monobloc

Surtido 6 boquillas monobloc

art.	Ø mm.	stars
47355-02	2,5	6
47355-04	4,0	6
47355-06	6,0	6
47355-08	8,0	7
47355-10	10	8
47355-12	12	10

Set 6 pcs, one piece nozzles

Set 6 bocchette unipezzo

Tüllen Set 6 Stk. aus einem Stück gezogen

Set 6 pcs douilles monobloc

Surtido 6 boquillas monobloc

art.	Ø mm.	stars
47356-02	2,0	5
47356-04	4,0	9
47356-06	5,5	9
47356-08	7,0	10
47356-10	8,5	12
47356-12	13,0	15
47356-14	14,5	16
47356-16	16,0	17
47356-18	17,5	18



Set 6 pcs, one piece nozzles

Set 6 bocchette unipezzo

Tüllen Set 6 Stk. aus einem Stück gezogen

Set 6 pcs douilles monobloc

Surtido 6 boquillas monobloc

art.	Ø mm.
47353-02	2
47353-04	4
47353-06	6
47353-08	8
47353-10	10
47353-12	12
47353-14	14
47353-16	16
47353-18	18
47353-20	20
47353-22	22
47353-24	24

Set 6 pcs, one piece nozzles

Set 6 bocchette unipezzo

Tüllen Set 6 Stk. aus einem Stück gezogen

Set 6 pcs douilles monobloc

Surtido 6 boquillas monobloc

art.	Ø mm.
47207-20	20
47207-25	25
47207-30	30

Set 10 pcs Bismark nozzles

Set 10 bocchette a imbuto

Fülltüllen Set 10 Stk.

Set 10 douilles à choux

Surtido 10 boquillas para relleno

art.	Ø mm.	l. mm.
47127-04	4	90
47127-06	6	75
47127-08	8	90



Nozzle
Bocchetta decorativa
Spritztülle
Douille
Boquilla

art.	Ø mm.	h. cm.
47357-50	55	6



Nozzle
Bocchetta decorativa
Spritztülle
Douille
Boquilla

art.	Ø mm.	h. cm.
47357-51	55	5,6



Nozzle
Bocchetta decorativa
Spritztülle
Douille
Boquilla

art.	Ø mm.	h. cm.
47357-40	32	6,0



Nozzle
Bocchetta decorativa
Spritztülle
Douille
Boquilla

art.	Ø mm.	h. cm.
47357-41	32	5,7



Nozzle
Bocchetta decorativa
Spritztülle
Douille
Boquilla

art.	Ø mm.	h. cm.
47357-42	32	5,7



Nozzle
Bocchetta decorativa
Spritztülle
Douille
Boquilla

art.	Ø mm.	h. cm.
47357-43	32	5,7



Nozzle
Bocchetta decorativa
Spritztülle
Douille
Boquilla

art.	Ø mm.	h. cm.
47357-44	32	5,7



Set of 6 nozzles
Set 6 bocchette
Tüllen Set, 6 Stk
Set 6 douilles
Juego 6 boquillas

art.	Ø mm.
47214-86	5-7-9-11-13-15

PP



Set of 6 nozzles
Set 6 bocchette
Tüllen Set, 6 Stk
Set 6 douilles
Juego 6 boquillas

art.	Ø mm.
47215-86	3-5-7-9-11-13

PP



Set of 12 nozzles
Set 12 bocchette
Tüllen Set, 12 Stk
Set 12 douilles
Juego 12 boquillas

art.	Ø mm.
47618-10	2>10
47618-20	10>20

PP

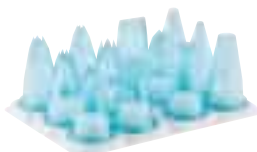

Set of 12 nozzles
Set 12 bocchette
Tüllen Set, 12 Stk
Set 12 douilles
Juego 12 boquillas

art.
47250-12

PC

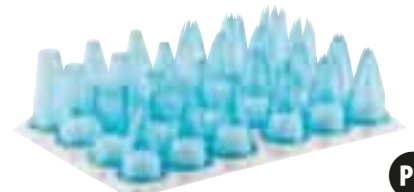

Set of 24 nozzles
Set 24 bocchette
Tüllen Set, 24 Stk
Set 24 douilles
Juego 24 boquillas

art.
47250-24

PC



Flower nozzles 12 pcs
 Bocchette floreali 12 pz
 Spritztüllen 12 Stk
 Douille fleurs 12 pcs
 Boquillas florales 12 pz

art.
 47357-38



Set of 29 nozzles
 Set 29 bocchette
 Tüllen Set, 29 Stk
 Set 29 douilles
 Juego 29 boquillas

art.
 47219-29

26 tubes, 2 flower nails, 1 standard coupler. – 26
 bocchette, 2 chiodi per fiori, 1 adattatore standard.



Set of 38 nozzles
 Set 38 bocchette
 Tüllen Set, 38 Stk
 Set 38 douilles
 Juego 38 boquillas

art.
 47219-38

35 tubes, 1 medium coupler, 1 large coupler. – 35
 bocchette, 1 adattatore medio, 1 grande.



Set of 55 nozzles
 Set 55 bocchette
 Tüllen Set, 55 Stk
 Set 55 douilles
 Juego 55 boquillas

art.
 47219-55

52 tubes, 2 flower nails, 1 standard coupler. – 52
 bocchette, 2 chiodi per fiori, 1 adattatore standard.



External piping tip adapter
 Adattatore per bocchette
 Adapter für Spritztüllen
 Adaptateur à douilles
 Adaptador para boquillas

art. Ø mm. des.
 47212-01 18 STANDARD



External piping tip adapter
 Adattatore per bocchette
 Adapter für Spritztüllen
 Adaptateur à douilles
 Adaptador para boquillas

art. Ø mm. des.
 47212-02 25-31 MEDIUM



External piping tip adapter
 Adattatore per bocchette
 Adapter für Spritztüllen
 Adaptateur à douilles
 Adaptador para boquillas

art. Ø mm. des.
 47212-03 36 LARGE





Nozzles adapter, 2 pcs

Adattatori per bocchette, 2 pz
Spritztüllen-Adapter, 2 Stk
Adaptateurs à douilles, 2 pièces
Adaptadores boquillas, 2 piezas

art.
47212-05

**To prepare decorations with 2 or 3 colours.
Suitable for piping tips base Ø 30 h 50 mm.**
Per decorazioni a 2 o 3 colori. Adatte a bocchette
base Ø 30 h 50 mm.



Pastry tube brush, 6 pcs

Bruschino per bocchette, 6 pz
Tüllen-Bürste, 6 Stk
Brosse à douilles, 6 pcs
Cepillo para boquillas, 6 pz

art.	Ø cm.	l. cm.
47200-01	0,8	10
47200-02	0,5-2,4	12,5



Cream roll molds, 10 pcs

Cannoli, 10 pz
Sahnerolle, konisch/gerade, 10 Stk
Rouleau à fromage, 10 pcs
Rodillos queso, 10 pz

art.	Ø mm.	l. mm.
47020-15	15	92
47020-20	22	142
47020-30	10-25	139
47020-35	20-25	171



Cream horn molds, 10 pcs

Cornetti, 10 pz
Schillerlockenform, 10 Stk
Moulet à cornet, 10 pcs
Moldes para conos, 10 pz

art.	Ø mm.	l. mm.
47021-35	34	110
47021-45	47	161



Icing bag

Sacchetto per decorare
Spritzbeutel
Sac à dresser
Mangas para decorar

art.	h. cm.	U. Pack
47106-28	28	6
47106-34	34	6
47106-40	40	6
47106-46	46	6
47106-50	50	6

Synthetic fibre with multi-layer water-proof plastic coating.



Icing bag

Sacchetto per decorare
Spritzbeutel
Sac à dresser
Mangas para decorar

art.	h. cm.	U. Pack
47106-55	55	6
47106-60	60	6
47106-65	65	6
47106-70	70	6
47106-75	75	6

Fibra sintetica con rivestimento a strati in plastica impermeabile.



Icing bag

Sacchetto per decorare
Spritzbeutel
Sac à dresser
Mangas para decorar

art.	h. cm.	U. Pack
47105-28	28	6
47105-34	34	6
47105-40	40	6
47105-46	46	6
47105-50	50	6

Polyurethane coated cotton fabric. Waterproof, suitable for all mixtures. With top seam, hanger and reinforced tip.



Icing bag

Sacchetto per decorare
Spritzbeutel
Sac à dresser
Mangas para decorar

art.	h. cm.	U. Pack
47105-55	55	6
47105-60	60	6
47105-65	65	6
47105-70	70	6
47105-75	75	6

Tessuto di cotone rivestito in poliuretano. Impermeabile, adatto a tutte le miscele. Con orlo superiore, gancio e punta rinforzata.



PE

Double pastry bag

Sacchetto per decorare doppio
Doppeldressierbeutel
Sac à dresser, double
Mangas para decorar, doble

art.	my	cm.	pcs/pz
471104-45	70	45,5x30,5	75

Disposable. For 2 ingredients. Closed tip, can be used without tube.

Monouso. Per 2 ingredienti. Punta chiusa, può essere utilizzato senza bocchette.



Icing bag, polyurethane

Sacchetto per decorare, poliuretano
Spritzbeutel, Polyurethan
Sac à dresser, polyuréthane
Mangas para decorar, poliuretano

art.	h. cm.
471112-34	34
471112-45	45
471112-50	50



PE

Disposable icing bag

Sacchetto per decorare, monouso
Einwegspritzbeutel
Sac à dresser jetable
Mangas desechables

art.	my	h. cm.	pcs/pz
471118-30	80	30	100
471118-40	80	40	100
471118-55	80	55	100
471118-65	80	65	100



PE

Disposable icing bag

Sacchetto per decorare, monouso
Einwegspritzbeutel
Sac à dresser jetable
Mangas desechables

art.	my	h. cm.	pcs/pz
471111-30	80	30	100
471111-40	80	40	100
471111-46	80	46	100
471111-55	80	55	100



SS

Cookie press set

Siringa per pasticceria
Gebäckpresse
Seringue à biscuits
Juego pistola repostería

art.	ml.
47010-20	250

For a correct use of the syringe we suggest shortbread dough. – Per un utilizzo ottimale della siringa suggeriamo la frolla montata.



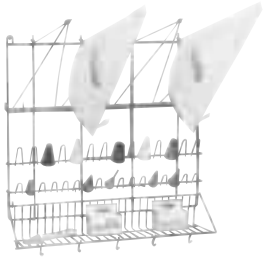

SS

Icing bags & nozzles wall rack

Espositore sacchetti/bocchette
Spritzbeutel-/ u. Tüllenaufhänger
Séchoir à poche et douilles
Secador mangas y boquillas

art. dim. cm.
47113-03 50x42x50



SS

Wall rack for icing bags

Espositore per sacchetti
Spritzbeutelaufränger
Séchoir à poche
Secador cuelga-mangas

art. dim. cm.
47107-00 50x42x26

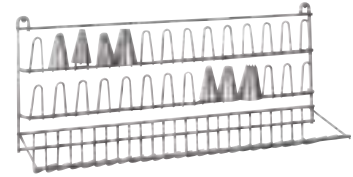

SS

Wall rack for nozzles

Espositore per bocchette
Tüllenaufhänger
Séchoir à douilles
Secador boquillas

art. dim. cm.
47108-00 50x13x24



PP

Icing bag holder

Vaso porta sacchetto
Spritzbeutel-Absetzständer
Support à poches
Soporte para mangas

art. Ø cm. h. cm.
47110-23 19,5 23



Cake plate, swivel base, aluminum

Girello, alluminio
Tortendrehscheibe, aluminium
Guéridon plaque tournante, alu
Pedestal giratorio para tartas, aluminio

art. dim. cm.
47101-40 30x40x10



MF

Cake-plate, swivel base

Girello per decorazione torte
Tortendrehscheibe
Guéridon plaque tournante
Pedestal giratorio para tartas

art. Ø cm. h. cm.
47103-32 32 10



PE

Protection cover

Campana
Abdeckhauben
Cloche
Tapa

art. Ø cm. h. cm.
47103-30 30 12



SS

Cake peel

Pala per torte
Tortenschaufel
Pelle à tarte
Pala para tartas

art. Ø cm. dim. cm.
47094-30 30 27x26



Doilies

Pizzi sottotorta
Tortenspitzen, Rosendekor
Dentelles décor rose
Blondas

art. dim. cm. pcs/pz
47687-24 18-25 250



Doilies

Pizzi sottotorta
Tortenspitzen, Rosendekor
Dentelles décor rose
Blondas

art. dim. cm. pcs/pz
47686-10 6-10 250
47686-12 6,5-12 250
47686-14 8-14 250
47686-17 9,5-16,5 250
47686-22 12,5-22 100
47686-24 15-24 100



Doilies

Pizzi sottotorta
Tortenspitzen, Rosendekor
Dentelles décor rose
Blondas

art. dim. cm. pcs/pz
47686-26 16-27 100
47686-30 19-30 100
47686-33 20-32 100
47686-36 32-36 100
47686-42 25-42 100

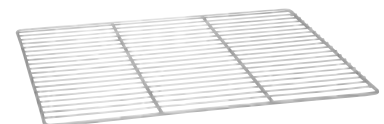

SS

Draining rack

Griglia di colagger
Überziehgitter
Grille à glacer
Rejilla

art. dim. cm.
44430-60 60x40

Frame ø mm 5, 2 cross-bars, 29 wires ø 2 mm.
Quadro ø mm 5, 2 traverse, 29 fili ø 2 mm.

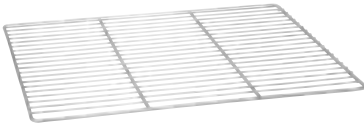

SS

Draining rack
Griglia di colaggio
Überziehgitter
Grille à glacer
Rejilla

art.	dim. cm.
44430-61	60x40

Frame ø mm 6, 2 cross-bars, 24 wires ø 3 mm.
Quadro ø mm 6, 2traverse, 24 fili ø 3 mm.



SS

Draining rack
Griglia di colaggio
Überziehgitter
Grille à glacer
Rejilla

art.	dim. cm.
44431-46	46x30,5x2,5
44431-60	60x40x2,5

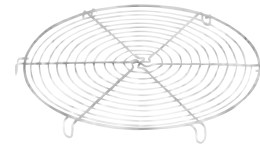

Cake cooling tray, chromed
Griglia di raffreddamento, cromata
Tortengitter, verchromt
Grille ronde à tourte, chromé
Rejilla para tortas, cromada

art.	Ø cm.
47098-18	18,5
47098-22	22,0
47098-26	26,0
47098-30	30,0



Baking tray, aluminum
Teglia, alluminio
Backblech, Aluminium
Plaque à cuisson, aluminium
Placa pastelería, aluminio

art.	GN	dim. cm.
41744-32	1/1	32,5x53x1
41744-53	2/1	53x65x1
41744-60	-	60x40x1

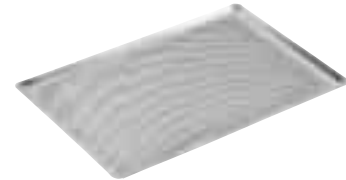

Baking tray perforated, aluminum
Teglia forata, alluminio
Backblech, Aluminium, gelocht
Plaque perforée, aluminium
Placa pastelería perforada, aluminio

art.	GN	dim. cm.
41756-30	-	30x40x1
41756-32	1/1	32,5x53x1
41756-53	2/1	53x65x1
41756-60	-	60x40x1



Baking tray, alusteel
Teglia rettangolare, alluminata
Backblech mit Aluminiumüberzug
Plaque, tôle aluminitée
Placa pastelería, aluminizada

art.	dim. cm.
41746-60	60x40x2



Baking tray, alusteel
Teglia rettangolare, alluminata
Backblech mit Aluminiumüberzug
Plaque, tôle aluminitée
Placa pastelería, aluminizada

art.	dim. cm.
41751-30	30x23x3
41751-35	35x28x3
41751-40	40x30x3
41751-50	50x35x3
41751-60	60x40x3
41751-65	65x45x3



Baking tray, non stick coated
Teglia rettangolare, antiaderente
Backblech mit Antihftbeschichtung
Plaque revêtement anti-adhésif
Placa pastelería anti-adherente

art.	dim. cm.
41747-60	60x40x2





Baking tray, aluminum, silicone coated

Teglia, alluminio siliconato
Alu-Backblech, Silikonbeschichtet
Plaque alu, revêtement silicone
Placa aluminio siliconada

art.	GN	dim. cm.
41743D32	1/1	53x32,5
41743D53	2/1	53x65
41743D60	-	40x60

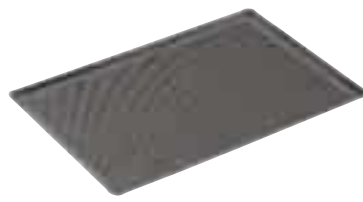

Baking tray, perforated aluminum, silicone coated

Teglia, alluminio siliconato, forato
Alu-Backblech, gelocht, Silikonbeschichtet
Plaque alu perforée, revêtement silicone
Placa aluminio perforada siliconada

art.	GN	dim. cm.
41753D30	-	30x40
41753D32	1/1	53x32,5
41753D53	2/1	53x65
41753D60	-	40x60



Bread mold, blue steel

Bacinella carré, ferro blu
Brotform, Blaublech
Pain de mie, tôle bleuie
Molde, hierro

art.	dim. cm.
41748-20	20x10x10
41748-30	30x10x10
41748-35	35x10x10
41748-40	40x10x10
41748-50	50x10x10



Bread mold, alusteel

Bacinella carré, alluminata
Brotform mit Aluminiumüberzug
Pain de mie, tôle aluminitée
Molde, acero aluminizado

art.	dim. cm.
41750-20	20x10x10
41750-30	30x10x10
41750-40	40x10x10
41750-41	40x15x15
41750-50	50x10x10



Confectionery funnel

Imbuto colatore
Likör- u. Fondanttrichter
Entonnoir à confiserie
Embudo de confitería

art.	Ø cm.	h. cm.	lt.
47800-22	21	31,5	2

Supplied with 3 nozzles ø 4, 5, 6 mm.
Con 3 bocchette ø 4, 5, 6 mm.



Confectionery funnel

Imbuto colatore
Likör- u. Fondanttrichter
Entonnoir à fondant
Embudo colador

art.	Ø cm.	h. cm.	lt.
47801-20	14	20	0,9

Supplied with 3 nozzles ø 4, 6, 7,5 mm.
Con 3 bocchette ø 4, 6, 7,5 mm.



Cream dispenser

Dosa creme
Dosierer
Doseur à crème
Dosificador

art.	dim. cm.
47612-01	20x16x23



Cream injector

Dosatrice per creme
Gebäkfüllmaschine
Entonnoir à crème
Dosificador de porciones

art.	dim. cm.	lt.
47694-03	25x44x20	3

Body in polished aluminum. Funnel, cylinder, piston, injector, lever and thrust rib in s/s. Piston: ø 24 mm. Doses: 1-12 gr. Incl. 3 injectors ø 5, 6 and 7 mm. – Corpo in alluminio brillantato. Imbuto, cilindro, pistone, iniettore, leva e nasello di spinta inox. Pistone ø 24 mm. Dosi 1-12 gr. Incl. 3 iniettori ø 5, 6 e 7 mm.



Electric caramelize rod

Caramellizzatore elettrico
Caramelaiser-Eisen, elektrisch
Fer à caraméliser électrique
Quemador eléctrico

art.	Ø cm.	kW
47847-10	10	0,65
47847-12	12	1,00



Electric caramelising rod

Caramellizzatore elettrico
Caramelisier-Eisen, elektrisch
Fer à caraméliser électrique
Quemador eléctrico

art.	l. cm.	kW
47847-23	23	1,5



SS

Sugar lamp

Lampada per zucchero
Zuckerlampe
Lampe à sucre
Lámpara para azúcar

art.	dim. cm.
47840-11	61x41x50

Infrared lamp, 3 selection powers 500-1000-1500W. Cable included. – Lampada infrarossi con 3 potenze selezionabili, 500-1000-1500W. Incl. cavo di alimentazione.



Electric spray gun

Pistola elettrica
Sprühpistole, elektrisch
Pistolet électrique
Pistola eléctrica

art.	ml.	W
47848-07	700	60

Bar 0-160, rpm 250 - For butter, oil, fat, wax, jelly, jam, chocolate, releasing agents and emulsions. Usable for hot liquids max. 65 °C. Nozzle 0,6 mm. – Per burro, oli, cera, gelatina, marmellata, cioccolata, antiagglomeranti ed emulsionanti. Per liquidi caldi max. 65°C. Bocchetta 0,6 mm.



Airbrush compressor

Compressore per penna aerografa
Airbrush Kompressor
Compresseur
Compresor

art.	dim. cm.	bar	kW
47844-06	16x30x23	4	0,2

Power 1/5 HP. Air output per min./litres: 23-25. Voltage: 220-240V/50HZ. Max. pressure 6,5 bar/95PSI. – Potenza 1/5 HP. Volume aria min. 23-25L. Voltaggio 220-240V/50HZ. Pressione Massima 6,5 bar/95PSI.



Airbrush, double action

Penna aerografa, doppia azione
Airbrush-Pistole, Doppelaktion
Aérographe, dual action
Equipo aerógrafo, doble acción

art.	Ø mm.	cap.
47844-02	0,3	7 cc



Airbrush stand

Supporto penna aerografa
Airbrush-Pistole Gestell
Support aérographe
Soporte aerógrafo

art.
47844-01



ABS

Tempering unit

Temperatrice
Temperiergerät
Tempereuse
Templadora

art.	Ø cm.	h. cm.	lt.
47698-01	20,5	21,2	1,7

Ideal for chocolate coatings of ice creams on sticks. Removable anodized aluminum tank. Ideale per coperture in cioccolato di gelati su stecco. Vasca estraibile in alluminio anodizzato.



ABS

Tempering unit

Temperatrice
Temperiergerät
Tempereuse
Templadora

art.	Ø cm.	h. cm.	lt.
47698-02	26	16	1,8

Mini dry melter, allows to process tiny chocolate quantities. Practical removable tank. Mini scioglitore a secco, adatto per piccole produzioni. Pratica vasca estraibile.





SS
ABS

Tempering unit

Temperatrice
Temperiergerät
Tempereuse
Templadora

art.	dim. cm.	lt.
47698-03	40x24x13,5	3,6
47698-06	40x33x13,5	6,0

Analog tempering units. Different wirings upon request. – Temperatrici analogiche. Su richiesta cablaggio: GB/USA/GIAPPONE/AUSTRALIA/CINA.



ABS
SS

Tempering unit, digital

Temperatrice digitale
Temperiergerät, digital
Tempereuse digitale
Templadora digital

art.	dim. cm.	lt.
47698-07	40x33x13,5	6,0

With thermal probe. Tempering manually adjustable or following the 3 programs: white, milk and dark chocolate.

Con sonda termica. Temperaggio regolabile manualmente o seguendo i 3 programmi per cioccolato bianco, al latte e fondente.



Chef's torch

Cannello professionale
Profi-Wärmepistole
Chalumeau de cuisine
Soplete cocina

art.	dim. cm.	ml.
47841-03	8x7x16	200



Chef's torch

Cannello professionale
Profi-Wärmepistole
Chalumeau de cuisine
Soplete cocina

art.	dim. cm.	ml.
47841-04	12x7x18	280



Sugar bulb

Pompette con terminale in rame
Blaszuckerspritze
Poire à sucre soufflé
Pera para azúcar soplado

art.	ml.
47838-00	280



Sugar/jam thermometer

Termometro per zucchero/marmellata
Zucker- und Marmeladenthermometer
Thermomètre à sucre et confiture
Termómetro azúcar y mermelada

art.	scala	°C
47843-05	2°C	+40+200°C

Brass. – Ottone. Dim. 4,7x20 cm.



SS

Sugar thermometer

Termometro per zucchero
Zuckerthermometer
Thermomètre à sucre
Termometro para azúcar

art.	scala	°C
47843-00	1°C	+80+200

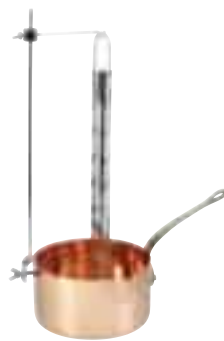

SS

Sugar thermometer holder

Reggi caramellometro
Zuckerthermometer-Träger
Support pour thermomètre à sucre
Soporte para termometro azúcar

art.	h. cm.
47842-00	32



Syrup density meter test tube

Provetta alimentare graduata, plastica
Sirup-Hydrometer-Becher
Epruvette pèse-sirop
Probeta aerómetro

art.	Ø cm.	h. cm.	ml.
49703-01	3	25	100

Can be sterilized up to 120°C.
Sterilizzabile fino a 120°C.



Syrup density meter

Pesa sciroppo (densimetro)
Sirup-Hydrometer
Pèse-sirop
Aerómetro

art.	l. cm.
49703-00	12,5

**Temp.: 20°C - gr./ml.°Bé: 1.100/1.400/15-40 -
Div.: 0,010 g/ml/2°Bé**



PA+
plus

Angular spatula

Spatola angolare
Winkelpalette
Spatule angulaire
Espátula angular

art.	l. cm.
12909-12	12
12909-23	23



ABS

Smoother

Paletta per lisciare
Teig-Glätter
Lisse-pâte

Espátula para alisar

art.	dim. cm.
47627-01	15x8



Biscuit spatula

Spatola per biscuit
Biscuit-Spachtel
Spatule à biscuit
Espátula para biscuit

art.	l. cm.
47626-55	55,5



Ruler

Riga
Lineal
Règle
Regla

art.	l. cm.
47033-50	60

**5 divisions cm 12 and 7 divisions cm 8.
5 divisioni 12 cm e 7 da 8 cm.**



Cake slicer

Lira per pan di Spagna
Tortendrahtschneider
Lyre à genoise
Cortador de pasteles

art.	Ø cm.	h. cm.
47031-44	30	20>60



Cake slicer, 3 cutting wires

Lira per pan di Spagna, 3 fili
Tortendrahtschneider, 3 Drähte
Lyre à genoise, 3 lames
Cortador de pasteles 3 alambres

art.	Ø cm.	h. cm.
47031-46	46	10>90



PE

Ganache frame set

Set telaio per ganache
Ganache Rahmenset
Ensemble cadres à ganache
Conjunto de marcos para ganache

art.	cm. int.
47693-00	24x24

**Base, 2 frames H 5 mm, 2 frames H 3 mm.
Base, 2 telai H 5 mm, 2 telai H 3 mm.**



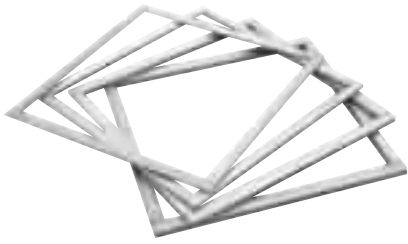

SS

Single frame
Telaio singolo
Rahmen
Cadre
Marco

art.	cm. ext.	cm. int.	h. mm.
47693-03	38x38	36x36	3
47693-05	38x38	36x36	5
47693-10	37x37	36x36	10
47693-15	37x37	36x36	15

To produce perfect layers. – Per creare stratificazioni precise.



PE

ABS

SS

Mini guitar
Chitarra mini
Pralinenschneider Mini
Mini-guitare
Mini guitarra

art.	dim. cm.
47692-03	44,5x33,5x14

Cutting frame 22 mm., s/s plate, plastic spatula, 3 spare wires, 2 spanners. Do not use for frozen pies, chocolate bars or generally hard paste. Cutting place 25x28 cm. – Telaio di taglio 22 mm., piatto inox, spatola plastica, 3 fili di ricambio, 2 chiavi. Non usare per torte congelate, tavolette di cioccolato, impasti duri in genere. Piano di taglio 25x28 cm.



SS

Guitar
Chitarra
Pralinenschneider
Guitare simple
Guitarra

art.	dim. cm.	Cut/Taglio	Kg.
47692-11	53x45x16 mm	360x420	16

Construction in PE, PS and s/steel frames. Includes s/s plate, spatula, 3 spare threads, 2 fixing keys, 3 frames 22,5-30-45 mm. – Costruzione in PE, PS e telai inox. Incl piatto inox, racla, 3 fili ricambio, 2 chiavi di fissaggio, 3 telai da 22,5-30-45 mm.



SS

Double guitar
Chitarra doppia
Pralinenschneider, doppelt
Guitare double
Guitarra doble corte

art.	dim. cm.	Cut/Taglio	Kg.
47692-22	50x48x15 mm	360x350	19,6

Construction in aluminum, PS and s/steel frames. Includes s/s plate, spatula, 3 spare threads, 2 fixing keys, 3 frames 22,5-30-45 mm. – Costruzione in alluminio, PS e telai inox. Incl piatto inox, racla, 3 fili ricambio, 2 chiavi di fissaggio, 3 telai da 22,5-30-45 mm.



SS

Guitar
Chitarra
Pralinenschneider
Guitare simple
Guitarra

art.	dim. cm.	Cut/Taglio	Kg.
47692-25	60x40x11 mm	380x400	24

Construction in aluminum, s/steel frames. Includes s/s plate, spatula, maintenance kit, 3 frames 22,5-30-45 mm. – Costruzione in alluminio, telai inox. Incl piatto inox, racla, kit assistenza, 3 telai da 22,5-30-45 mm.





SS

Expanding pastry cutter

Tagliapasta estensibile
Teigschneider
Rouleau extensible
Cortapastas extensible

art. Ø cm. l. cm. wheels

47820-05 5,5 24 5

47820-07 5,5 24 7

Plain wheels. – Rotelle lisce.



SS

Expanding pastry cutter

Tagliapasta estensibile
Teigschneider
Rouleau extensible
Cortapastas extensible

art. Ø cm. l. cm. wheels

47821-05 5,5 24 5

47821-07 5,5 24 7

Fluted wheels. – Rotelle ondulate.



SS

Expanding pastry cutter

Tagliapasta estensibile
Teigschneider
Rouleau extensible
Cortapastas extensible

art. Ø cm. l. cm. wheels

47822-05 5,5 28 5x2

47822-07 5,5 28 7x2

Plain wheels. – Rotelle lisce.



SS

Pastry wheel, plain

Rotella taglia pasta liscia
Teigrädchen, glatt
Roulette à pâte lisse
Ruleta cortapasta

art. Ø cm. l. cm.

18325-01 5,5 18



SS

Pastry wheel, fluted

Rotella taglia pasta ondulata
Teigrädchen, gewellt
Roulette à pâte cannelée
Ruleta cortapasta acanalada

art. Ø cm. l. cm.

18325-02 5,5 18



SS

Double pastry wheel

Rotella taglia pasta lama doppia
Teigrädchen, glatt u. gewellt
Roulette à pâte double
Ruleta cortapasta doble

art. Ø cm. l. cm.

18325-03 5,5 18



Cutting roller, POM

Rullo tagliapasta, POM
Rollmesser, POM
Rouleau à lamelles, POM
Rodillo, POM

art. cm.

47026-06 6



Spiked roller, POM

Rullo bucasfoglia, POM
Stipprolle, POM
Pique-pâte, POM
Rodillo, POM

art. cm.

47024-06 6,0

47024-10 11,5

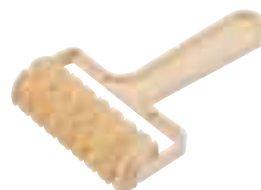

Cutting roller, POM

Rullo per losanghe, POM
Rollmesser, POM
Rouleau à losanges, POM
Rodillo a rombos, POM

art. cm.

47025-06 6,0

47025-10 11,5



SS

Spiked roller

Rullo bucasfoglia
Stipprolle
Pique-pâte
Rodillo

art. cm.

47028-12 12



SS

Cutting roller

Rullo per losanghe
Rollmesser
Rouleau à losanges
Rodillo a rombos

art. cm.

47029-12 12



PP

SS

Croissant cutter

Taglia croissants
Dreieckschneidwalze
Coupe-croissants
Cortador para croissants

art. dim. cm.

47027-11 18x20

47027-12 18x14

47027-14 9,7x21

47027-15 18x20 2x

47027-16 18x20 3x



PS

Stencil for grating pastry
Stampo decora crostate
Gitterstempel
Empreinte pour grille de pâte
Molde tortas

art.	Ø cm.
47030-30	30



PP

Cake marker
Segnaporzioni
Tortenteiler
Diviseur à tarte
Marcador de tartas

art.	Ø cm.	por.
47032-10	26,5	10
47032-20	26,5	20



PP

Cake marker, double-sided
Segnaporzioni, doppio
Tortenteiler, doppelseitig
Diviseur à tarte, double
Marcador de tartas, doble

art.	Ø cm.	por.
47033-08	18	8-12
47033-12	26,5	12-18
47033-14	26,5	14-18



Rolling pin, non-stick coated
Rullo antiaderente
Rollwalze mit Antihafbeschichtung
Rouleau avec revêtement anti-adhésif
Rodillo amasador anti-adherente

art.	Ø cm.	l. cm.
47035-40	5,5	20
47035-48	6,5	25



W

Rolling pin
Rullo
Rollwalze
Rouleau
Rodillo amasador

art.	Ø cm.	l. cm.
47036-30	9	30
47036-35	9	35
47036-40	9	40
47036-45	9	45
47036-50	9	50
47036-60	9	60



W

Rolling pin
Rullo
Rollwalze
Rouleau
Rodillo amasador

art.	Ø cm.	l. cm.
47038-50	9	50
47038-60	7	60



PE

Rolling pin
Rullo
Rollwalze
Rouleau
Rodillo amasador

art.	Ø cm.	l. cm.
47037-30	8	30
47037-40	8	40



PE

Rolling pin
Rullo
Rollwalze
Rouleau
Rodillo amasador

art.	Ø cm.	l. cm.
47034-23	2,5	23
47034-51	5,0	50

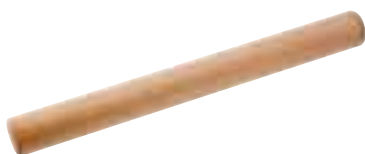

W

Rolling pin
Rullo
Rollwalze
Rouleau
Rodillo amasador

art.	Ø cm.	l. cm.
47034-52	5	50

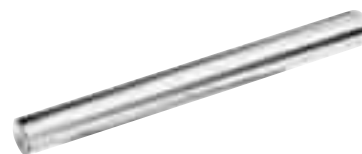

SS

Rolling pin
Rullo
Rollwalze
Rouleau
Rodillo amasador

art.	Ø cm.	l. cm.
47034-50	5	50



Pastry brush

Pennello per alimenti
Kuchenpinsel
Pinceaux à pâtissier
Pincel de cocina

art.	cm.	U. Pack
47644-30	3	1
47644-40	4	1
47644-50	5	1
47644-60	6	1
47644-70	7	1

Synthetic bristles. Resistant up to 120°C and dishwasher safe. – Setole sintetiche. Resistente fino a 120°C e lavabile in lavastoviglie.



Pastry brush

Pennello per alimenti
Kuchenpinsel
Pinceaux à pâtissier
Pincel de cocina

art.	cm.	U. Pack
47642-30	3,0	6
47642-40	4,0	6
47642-50	5,0	6
47642-60	6,0	6
47642-70	7,5	6

Plastic handle, stainless steel ferrule.
Manico plastica, ghiera inox.



Pastry brush non-stick coated bristles

Pennello setole antiaderenti
Pinsel, antihafbeschichtete Borsten
Pinceau poils anti-adhérentes
Pincel cerdas antiadherentes

art.	cm.	U. Pack
47640-25	2,5	1
47640-35	3,5	1
47640-50	5,0	1
47640-59	6,0	1

Nylon bristles. Heat resistant up to +150°C.
Setole nylon. Resistente al calore fino a +150°C.



PA

Pastry brush

Pennello per alimenti
Kuchenpinsel
Pinceaux à pâtissier
Pincel de cocina

art.	cm.	U. Pack
47645-40	4	6
47645-60	6	6
47645-75	7,5	6

Natural bristles. – Setole naturali.



PA

Pastry brush

Pennello per alimenti
Kuchenpinsel
Pinceaux à pâtissier
Pincel de cocina

art.	cm.	U. Pack
47646-40	4	6
47646-60	6	6
47646-75	7,5	6

Polyester bristles. – Setole in poliestere.



PP

Set 10 dough scrapers

Set 10 raschiatti
Teigschaber, 10 Stk.
Set 10 raclettes
Conjunto 10 rasquetas

art.	dim. mm.
47621-01	216x128



PP

Set 10 dough scrapers

Set 10 raschiatti
Teigschaber, 10 Stk.
Set 10 raclettes
Conjunto 10 rasquetas

art.	dim. mm.
47621-02	120x86



PP

Set 10 dough scrapers

Set 10 raschiatti
Teigschaber, 10 Stk.
Set 10 raclettes
Conjunto 10 rasquetas

art.	dim. mm.
47621-03	120x88



PP

Set 10 dough scrapers

Set 10 raschiatti
Teigschaber, 10 Stk.
Set 10 raclettes
Conjunto 10 rasquetas

art.	dim. mm.
47621-04	121x81



PP

Set 10 dough scrapers

Set 10 raschiatti
Teigschaber, 10 Stk.
Set 10 raclettes
Conjunto 10 rasquetas

art.	dim. mm.
47621-05	148x99



PP

Set 10 decorating combs

Set 10 pettini decoratori
Dekorationskamm, 10 Stk
Set 10 peignes à decor
Conjunto 10 peines decoradores

art.	dim. mm.
47621-06	145x99



PP

Set 10 decorating combs

Set 10 pettini decoratori
Dekorationskamm, 10 Stk
Set 10 peignes à decor
Conjunto 10 peines decoradores

art.	dim. mm.
47621-07	110x80



PP

Set 10 decorating combs

Set 10 pettini decoratori
Dekorationskamm, 10 Stk
Set 10 peignes à decor
Conjunto 10 peines decoradores

art.	dim. mm.
47621-08	216x128



SS

Set 3 decorating combs

Set 3 pettini decoratori
Dekorationskamm, 3 Stk
Set 3 peignes à decor
Conjunto 3 peines decoradores

art.	dim. mm.
47625-03	100x100



SS

Sugar dregger

Spargi zuccherò
Zuckerstreuer
Glacière à sucre
Dosificador para azúcar

art.	Ø cm.	h. cm.
47022-12	7	9



PE

Moisture bottle

Flacone per bagna
Sprühflasche
Bouteille à puncher
Frasco nebulizador

art.	dim. cm.	lt.
47679-10	10x5,6x27,5	1



HDPE

Spraying bottle

Flacone nebulizzatore
Sprühflasche
Bouteille à puncher spray
Frasco nebulizador

art.	dim. cm.	lt.
47679-11	7x7x30	1



SS

Flour sifter

Setaccio farina
Einhand-Drücksieb
Tamiseur farine
Tamiz para harina

art.	Ø cm.	gr.
42607-05	12	500



Icing sugar sieve

Setaccio per zucchero a velo
Sieb für Puderzucker
Tamis à sucre glace
Cedazo para azúcar glas

art.	Ø cm.	h. cm.
47614-25	23	8



Sieve for flour

Setaccio rete farina
Sieb für Mehl
Tamis pour farine
Cedazo para harina

art.	Ø cm.	h. cm.
47615-25	23	8



Flour brush

Spazzola per farina
Mehlbürste
Brosse à pétrin
Cepillo para harina

art.	cm.
42614-21	30

Horse hair. – Setole di cavallo.



SS

Display tray

Vassoio espositore
Auslegeplatte
Plat patissier
Bandeja pastelería

art.	dim. cm.
47075-20	20x16x1
47075-30	30x21x1
47075-45	45x34x1



SS

Display tray

Vassoio espositore
Auslegeplatte
Plat patissier
Bandeja pastelería

art.	dim. cm.
42533-23	23x16,5x0,5
42533-26	26x19,5x0,5
42533-31	31x24x0,5
42533-36	36x28,5x0,5
42533-40	40x32,5x0,5



Display tray, aluminum

Vassoio espositore, alluminio
Auslegeplatte, Aluminium
Plat patissier, alu

Bandeja pastelería, aluminio

art.	dim. cm.
47070-37	37,5x24,5x1
47070-48	48x31x1
47070-60	60x40x1

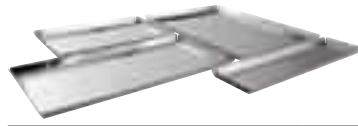

SS

Vassoio espositore
Auslegeplatte
Plat patissier
Bandeja pastelería

art.	dim. cm.
47074-01	30x20x1,5
47074-02	40x10x1,5
47074-03	40x20x1,5
47074-04	40x30x1,5



SS

Vassoio espositore
Auslegeplatte
Plat patissier
Bandeja pastelería

art.	dim. cm.
47074-05	50x10x1,5
47074-06	60x6x1,5
47074-07	60x10x1,5
47074-08	60x20x1,5



NEW

Baking paper, microperforated

Carta Forno Microforata
Backpapier, microperforiert
Feuille de cuisson, microperforé
Papel de horno, microperforado

art.	dim. cm.	pcs/pz
47682-40	59,2x39,2	200

Ideal for baking all leavened pastries, but also shortcrust pastry and meringues, it guarantees perfect baking in less time than traditional baking paper. Thanks to the micro-perforation, steam escapes faster during baking. This ensures a better passage of air, which also cools the products faster than with conventional baking paper.

Ideale per la cottura di tutte le paste lievitate, ma anche di bigné, pasta frolla, biscotti, pasta sfoglia e meringhe. Garantisce una cottura perfetta in minor tempo rispetto alla carta forno tradizionale. Durante la cottura, la microforatura permette al vapore acqueo di fuoriuscire più velocemente garantendo così un miglior passaggio dell'aria. Anche il raffreddamento dei prodotti è più rapido.



Baking paper, siliconized

Carta da forno siliconata
Baktrennfolie, silikonisiert
Feuille de cuisson, siliconée
Papel de horno siliconado

art.	dim. cm.	pcs/pz
47682-53	53x32,5	500
47682-60	60x40	500

Artificial parchment, bleached, g/m²: 41,0, both sides siliconized, reusable, for all kinds of dough.

Pergamena artificiale, sbiancata, g/m²: 41,0, siliconata fronte/retro, riutilizzabile, idonea per tutti i tipi di pasta.



Baking paper, PTFE coated

Carta da forno, rivestimento PTFE
Baktrennfolie, PTFE-beschichtet
Feuille de cuisson, revêtement PTFE
Papel de horno anti-adherente

art.	dim. cm.	U. Pack
47681-60	60x40	10

Fiberglass tissue coated on both sides, can be used up to 500 times, tear-proof. Carefully dry after use. – Tessuto fibra di vetro rivestito fronte/retro, resistente alla trazione, antiaderente, riutilizzabile più di 500 volte. Asciugare dopo l'uso.



Baking sheet, silicone, microperforated

Tappeto silicone microforato
Silikonbackmatte, microperforiert
Tapis cuisson en silicone, microperforé
Tapete de cocción silicona, microperforado

art.	GN	dim. cm.
47691-53	1/1	53x32,5
47691-64	-	60x40



Baking sheet, silicone

Tappeto silicone
Silikonbackmatte
Tapis cuisson en silicone
Tapete de cocción silicona

art.	GN	dim. cm.
47689-53	1/1	53x32,5
47689-60	-	60x40



SILPAT Silicone baking sheet

Tappeto silicone
Silikonbackmatte
Tapis cuisson en silicone
Tapete de cocción silicona

art.	GN	dim. cm.
47680-40	-	40x30
47680-53	1/1	53x32,5
47680-60	-	60x40



SILPAIN Silicone baking sheet

Tappeto silicone
Silikonbackmatte
Tapis de cuisson en silicone
Tapete de cocción silicona

art.	GN	dim. cm.
47685-53	1/1	53x32,5
47685-60	-	60x40



ROUL'PAT Silicone baking sheet

Tappeto silicone
Silikonbackmatte
Tapis de cuisson en silicone
Tapete de cocción silicona

art.	dim. cm.
47688-60	60x40



Baking beans, ceramic

Noccioli di cottura, ceramica
Blindbackkugeln, Keramik
Noyaux de cuisson, céramique
Núcleos de cocción, cerámica

art.	Kg.
47011-01	1



Sheets, PET

Fogli
Blätter
Feuilles
Hojas

art.	my	dim. cm.	pcs/pz
47131-30	90	30x30	50
47131-60	90	60x40	50

Ribbons and sheets to coat molds, to make and unmold single portions and mignons. Non-stick for food use. Suitable for cooling in blast chiller, freezer and fridge, not suitable for cooking. Extra transparent, super resistant.

Nastri e fogli per rivestire stampi, per realizzare e sfornare monoporzioni e mignon. Antiaderenti per uso alimentare. Adatti al raffreddamento in abbattitore, congelatore e frigo, non adatti alla cottura. Extra trasparenti, super resistenti.



Cake ribbon, PET

Nastro per dolci
Tortenrandband
Ruban pâtissier
Cinta para tartas

art.	my	h. cm.	mt.
47130-25	90	2,5	305
47130-30	90	3,0	305
47130-35	90	3,5	305
47130-40	90	4,0	305
47130-45	90	4,5	305
47130-50	90	5,0	305
47130-55	90	5,5	305
47130-60	90	6,0	305



SS

Tart ring

Anello per torte
Tortenring
Cercle à tarte
Anillo para tartas

art.	Ø cm.	h. cm.
47533-07	7	2
47533-08	8	2
47533-09	9	2
47533-10	10	2
47533-12	12	2
47533-14	14	2
47533-16	16	2
47533-18	18	2
47533-20	20	2
47533-22	22	2
47533-24	24	2
47533-26	26	2
47533-28	28	2
47533-30	30	2
47533-32	32	2



SS

Tart ring

Anello per torte
Tortenring
Cercle à tarte
Anillo para tartas

art.	Ø cm.	h. cm.
47530-14	14	3,5
47530-16	16	3,5
47530-18	18	3,5
47530-20	20	3,5
47530-22	22	3,5
47530-24	24	3,5
47530-26	26	3,5
47530-28	28	3,5
47530-30	30	3,5



SS

Mousse ring

Anello per mousse
Schaumspeisenring
Cercle à mousse
Anillo para mousse

art.	Ø cm.	h. cm.
47532-06	6,0	4,0
47532-07	7,5	4,0
47532-08	8,0	4,5
47532-12	12,0	4,5
47532-14	14,0	4,5
47532-16	16,0	4,5
47532-18	18,0	4,5
47532-20	20,0	4,5
47532-22	22,0	4,5
47532-24	24,0	4,5
47532-26	26,0	4,5



SS

Ice cream cake ring

Anello per torte gelato
Eistortenring
Cercle à vacherin
Circulo alto

art.	Ø cm.	h. cm.
47534-07	7	9
47534-08	9	9
47534-10	9	11



SS

Ice cream cake ring

Anello per torte gelato
Eistortenring
Cercle à vacherin
Circulo alto

art.	Ø cm.	h. cm.
47534-00	8	6
47534-01	10	6



SS

Ice cream cake ring

Anello per torte gelato
Eistortenring
Cercle à vacherin
Circulo alto

art.	Ø cm.	h. cm.
47534-06	6	6
47534-16	16	6
47534-18	18	6
47534-20	20	6
47534-22	22	6
47534-24	24	6
47534-26	26	6
47534-28	28	6



SS

Cake setting ring, flexible

Anello regolabile, flessibile
Tortenring, verstellbar, flexibel
Cercle à tarte réglable, flexible
Anillo ajustable, flexible

art.	Ø cm.	h. cm.
47529-07	16,5>32	8

MICROPERFORATED CAKE RINGS
FASCE MICROFORATE

SS



The micro-holes allow to support the edges of the cake avoiding to collapse during cooking. They also allow to expel the moisture from the dough, obtaining a perfect and always crispy cooking.

I microfori permettono di sostenere i bordi della torta evitandone il collasso in cottura. Consentono inoltre di espellere l'umidità, ottenendo una cottura sempre perfetta e croccante.



Cake ring, microperforated

Fascia microforata

Tarte-Rahmen perforiert

Cercle microperforé

Anillo tarta microperforado

art.	Ø cm.	h. cm.
47510-07	7	3,5
47510-09	9	3,5
47510-11	11	3,5
47510-13	13	3,5
47510-15	15	3,5
47510-17	17	3,5
47510-19	19	3,5
47510-21	21	3,5
47510-23	23	3,5
47510-25	25	3,5
47510-27	27	3,5
47510-29	29	3,5
47510-31	31	3,5



Cake ring, microperforated

Fascia microforata

Tarte-Rahmen perforiert

Cercle microperforé

Anillo tarta microperforado

art.	Ø cm.	h. cm.
47511-07	7	2
47511-09	9	2
47511-11	11	2
47511-13	13	2
47511-15	15	2
47511-17	17	2
47511-19	19	2
47511-21	21	2
47511-23	23	2
47511-25	25	2
47511-27	27	2
47511-29	29	2
47511-31	31	2

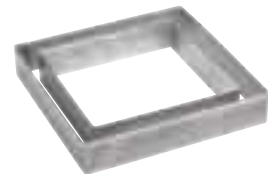

Cake ring, microperforated

Fascia microforata

Tarte-Rahmen perforiert

Cercle microperforé

Anillo tarta microperforado

art.	dim. cm.	h. cm.
47512-07	7x7	3,5
47512-09	9x9	3,5
47512-11	11x11	3,5
47512-13	13x13	3,5
47512-15	15x15	3,5
47512-17	17x17	3,5
47512-19	19x19	3,5
47512-21	21x21	3,5
47512-23	23x23	3,5
47512-25	25x25	3,5
47512-27	27x27	3,5
47512-29	29x29	3,5
47512-31	31x31	3,5

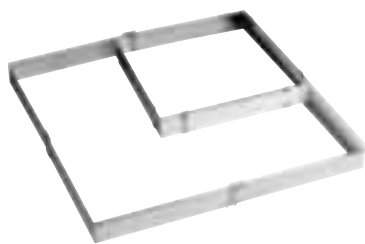

SS

Extensible frame
Telaio regolabile
Backrahm, verstellbar
Bande à tarte réglable
Marco para tarta, ajustable

art.	cm.	h. cm.
47526-05	30x30>57x56	5



SS

Extensible frame
Telaio regolabile
Backrahm, verstellbar
Bande à tarte réglable
Marco para tarta, ajustable

art.	cm.	h. cm.
47528-05	19x28>34x54	5



SS

Extensible heart frame
Telaio cuore regolabile
Herz-Backrahm, verstellbar
Bande à tarte réglable
Marco para tarta, ajustable

art.	cm.	h. cm.
47542-00	14,5>26,5	5



SS

Rectangle
Rettangolo
Rechteck
Rectangle
Rectangular

art.	dim. cm.
47527-55	55x35,5x4,5



SS

Rectangle
Rettangolo
Rechteck
Rectangle
Rectangular

art.	dim. cm.
47546-18	18x36x5
47546-30	30x40x5
47546-40	40x60x5



SS

Square
Quadrato
Viereck
Carré
Cuadrado

art.	dim. cm.
47548-02	10x10x4,5
47548-03	18x18x4,5
47548-04	20x20x4,5
47548-05	22x22x4,5



SS

Rounded square
Quadrato bombato
Viereck, konvex
Carré arrondi
Cuadrado abombado

art.	dim. cm.
47541-02	10x10x4,5
47541-03	18x18x4,5
47541-04	20x20x4,5



SS

Oval
Ovale
Oval
Ovale
Oval

art.	dim. cm.
47547-22	24,5x20x4
47547-26	30x23x4
47547-30	33x26,5x4



SS

Comma
Virgola
Komma
Virgule
Coma

art.	Ø cm.	h. cm.
47544-20	20	4
47544-25	25	4
47544-30	30	4





SS

Heart

Cuore
Herz
Coeur
Corazón

art.	Ø cm.	h. cm.
47542-18	18	4
47542-20	20	4
47542-22	22	4
47542-24	24	4
47542-26	26	4



SS

Triangle

Triangolo
Dreieck
Triangle
Triángulo

art.	Ø cm.	h. cm.
47540-02	12	4,5
47540-03	20	4,5
47540-04	22	4,5
47540-05	24	4,5

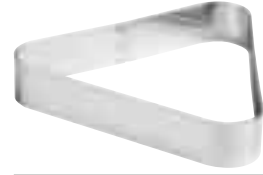

SS

Triangle

Triangolo
Dreieck
Triangle
Triángulo

art.	Ø cm.	h. cm.
47538-23	23	4
47538-26	26	4



SS

Rectangle

Rettangolo
Rechteck
Rectangle
Rectangular

art.	dim. cm.
47546-41	25x9x4
47546-42	30x9,1x4
47546-43	35x9,2x4



SS

Rectangle

Rettangolo
Rechteck
Rectangle
Rectangular

art.	dim. cm.
47546-51	25x9x5
47546-52	30x9,1x5
47546-53	35x9,2x5



SS

Pyramid

Piramide
Pyramide
Piramide
Pirâmide

art.	dim. cm.	h. cm.
47535-09	9x9	6
47535-12	12x12	8
47535-17	17x17	12
47535-19	19x19	13



SS

Half sphere

Semi-sfera
Halbkugel
Demi-sphère
Semiesfera

art.	Ø cm.	h. cm.
47536-12	12	6
47536-14	14	7
47536-20	20	10



SS

Crème caramel

Crème caramel
Crème caramel
Crème caramel
Molde para flan

art.	Ø cm.	h. cm.	ml.
41660-10	7	5	150
41660-15	7	6	180

STAINLESS STEEL MOLDS
STAMPI INOX

NEW **SS**



For geometric baking, perfect for making travel cakes and other baked desserts. Stainless steel molds with tubular insert, easily removable after baking in order to fill the cakes also with non-baked fillings.

Stampi in acciaio inox per cottura geometrica, per realizzare travel cake ed altri dolci da forno. Inserto tubolare facilmente estraibile dopo la cottura, per consentire la farcitura del dolce anche con ripieni non da forno.



Travel cake carré short
Mold Mm 103x190 H 70

art.	dim. mm.	ml.
47659-20	80x150x69	850



Travel cake carré
Mold Mm 82x290 H 64

art.	dim. mm.	ml.
47659-21	60x250x60	900



Travel cake triangle
Mold Mm 88x290 H 85

art.	dim. mm.	ml.
47659-22	82x250x80	890



Travel cake round
Mold Ø Mm 82 H 290

art.	Ø mm.	h. mm.	ml.
47659-24	78	250	1050



Travel cake cube
Mold Mm 103x86 H 83

art.	dim. mm.	ml.
47659-25	80x80x80	510



Travel cake dual
Mold Mm 255x84 H 62

art.	Cake	dim. mm.	ml.
47659-26	block	250x60x60	900
	oval	250x60x60	790

Two shapes in one mold: Block & Oval. Thanks to the insert you can make either rectangular and oval cakes. – Due forme con uno stampo: Block & Oval. Grazie all'inserto si può realizzare sia il cake rettangolare che ovale.



Piepan, aluminum

Tortiera, alluminio
Tortenform, Aluminium
Tourtière, alu
Molde, aluminio

art.	Ø cm.	h. cm.
16940-28	28	5,0
16940-32	32	5,5
16940-36	36	6,0
16940-40	40	6,5



Savarin tin, aluminum

Ciambella, alluminio
Savarinform, Aluminium
Moule à savarin, alu
Molde para savarin, aluminio

art.	Ø cm.	h. cm.	U. Pack
47060-06	6,0	2,5	3
47060-07	7,5	3,0	3
47060-09	9,0	3,5	3
47060-10	10,0	3,5	3
47060-12	12,0	5,5	3
47060-14	14,0	5,5	3
47060-16	16,0	5,5	3
47060-18	18,0	6,5	3
47060-20	20,0	6,5	3
47060-22	22,0	6,5	3
47060-24	24,0	8,5	3
47060-26	26,0	8,5	3
47060-30	30,0	8,5	3



Pandoro mold, aluminum

Stampo pandoro, alluminio
Pandoro-Form, Aluminium
Moule à pandoro, aluminium
Molde pandoro, aluminio

art.	Ø cm.	h. cm.	gr.
47063-01	10,8	8,0	100
47063-02	16,5	13,0	250
47063-05	19,5	14,5	500
47063-07	20,5	15,5	750
47063-10	23,0	17,0	1000



Gugelhupf, aluminum

Stampo americano, alluminio
Gugelhupfform, Aluminium
Moule à gugelhupf, alu
Molde gugelhupf, aluminio

art.	Ø cm.	h. cm.
47062-18	18	10,5
47062-20	20	11,0
47062-22	22	12,0



Plumcake, aluminum

Plumcake, alluminio
Plumcake, Aluminium
Plumcake, alu
Molde para plumcake, aluminio

art.	dim. cm.
47064-18	18x80x6
47064-22	22x90x7
47064-26	26x10x8
47064-30	30x11x9



Beaker shaped tin, aluminum

Stampo per babà, alluminio
Timbalform, Aluminium
Moule à dariole, alu
Molde, aluminio

art.	Ø cm.	h. cm.	U. Pack
47066-03	3	3,5	10
47066-04	4	4,5	10
47066-05	5	5,5	10
47066-06	6	6,0	10
47066-07	7	7,0	10
47066-08	8	8,0	10



Crème caramel, aluminum

Crème caramel, alluminio
Crème caramel, Aluminium
Crème caramel, alu
Molde crème caramel, aluminio

art.	Ø cm.	h. cm.	U. Pack
41659-06	6	4,8	6
41659-07	7	5,0	6
41659-08	8	5,3	6



Cassata mold, aluminum

Stampo cassata, alluminio
Cassataform, Aluminium
Moule à cassata, alu
Molde para cassata, aluminio

art.	Ø cm.	h. cm.
47068-12	12	10
47068-15	15	12



Zuccotto mold, aluminum

Stampo per zuccotto, alluminio
Zuccottoform, Aluminium
Moule à zuccotto, alu
Molde para zuccotto, aluminio

art.	Ø cm.
47069-10	10
47069-12	12
47069-14	14
47069-16	16
47069-18	18
47069-20	20

MODULAR SYSTEM BASE=LID EXTENSIBLE HEIGHT
SISTEMA MODULARE BASE=COPERCHIO ALTEZZA ESTENSIBILE



Modular system, the base and lid are the same element and due to the extender insert it is possible to increase capacity. Equipped with rotation system that allows steam to escape. On request dimensions 80x80 cm.

Sistema modulare, base e coperchio sono lo stesso elemento e grazie all'inserto estensore è possibile aumentare la capacità. Provvisto di sistema rotabile, per la fuoriuscita del vapore. A richiesta nelle dimensioni 80x80 cm.



Base and lid

Base e coperchio
 Basis und Abdeckung
 Base et couvercle
 Base y tapa

art.	cm. ext.	cm. int.
44975-50	57x57x9,5	51x51x6,3

Extender

Estensore
 Aufsatz
 Réhausse
 Extensión

art.	cm. ext.	cm. int.
44975H50	57x57x9,5	51x51x7,5x9,5



NON STICK CAKE MOLDS TORTIERE ANTIADERENTI

PASTRY
PASTICCERIA



Wash the mold before the first use. Slightly grease inside surface with oil, butter or margarine before baking. Allow cake to cool down a little before removing from the mold. For the cleaning, hand-wash with dish soap and dry the mold immediately after washing. Use only in traditional ovens (no microwave). Do not use sharp objects or others metal tools which could damage the pan surface. Do not use on a flame or other direct heat source, including stove tops. Do not exceed 230°C. Non-stick coating PFOA free.

Lavare lo stampo prima di utilizzarlo la prima volta. Ungere leggermente l'interno con olio, burro o margarina prima di infornare. Prima di sfornare, lasciare raffreddare per qualche minuto. Lavare a mano con detersivi liquidi ed asciugare lo stampo immediatamente dopo. Utilizzare esclusivamente in forni tradizionali (no microonde). Non utilizzare oggetti appuntiti, polveri abrasive o pagliette metalliche che possano rigare la superficie degli stampi. Evitare il contatto con fonti di calore dirette o fiamma libera. Non superare la temperatura massima di 230°C. Rivestimento antiaderente privo di PFOA.



Pine mold

Tortiera pino
Tannenbaumform
Tourtière pin
Molde pino

art.	dim. cm.
47005-24	17x24x8,5



Star mold

Tortiera stella
Sternform
Tourtière étoile
Molde estrella

art.	dim. cm.
47006-25	25x25x4,5



Crispy tart pan

Tortiera forata
Tortenform, gelocht
Tourtière perforée
Molde perforado

art.	Ø cm.	h. cm.
41729-30	29/27	1,5
41729-34	33/30	1,5



Round cake tin

Tortiera tonda
Tortenform, rund
Tourtière ronde
Molde redondo

art.	Ø cm.	h. cm.	U. Pack
47739-12	12	2,1	6
47739-24	24	2,3	1
47739-28	28	2,3	1
47739-32	32	2,5	1



Round cake tin

Tortiera tonda
Tortenform, rund
Manqué rond uni
Molde redondo

art.	Ø cm.	h. cm.
47710-12	12	3,0
47710-16	16	4,0
47710-20	20	4,5
47710-24	24	5,0
47710-28	28	5,0
47710-32	32	5,5



Round mold, fluted edges

Tortiera festonata
Runde Obsttortenform
Tourtière ronde bord cannelé
Molde rizado

art.	Ø cm.	h. cm.
47709-20	20	2,5
47709-24	24	2,5
47709-28	28	2,5
47709-32	32	2,5



Round mold, fluted, loose bottom

Tortiera festonata, fondo mobile
Tortenform, gewellter Rand, Heheboden
Tourtière cannelée, fond amovible
Molde acanalado, rizado, fondo desmontable

art.	Ø cm.	h. cm.
47712-20	20	2,5
47712-24	24	2,5
47712-28	28	2,5
47712-32	32	2,5



Savarin tin

Ciambella
Savarinform
Moule pour savarin
Molde Savarin

art.	Ø cm.	h. cm.	U. Pack
47711-08	8	2,0	6
47711-12	12	2,5	6
47711-22	22	4,5	1
47711-24	24	5,0	1
47711-26	26	6,2	1



Trois Frères cake ring

Tortiera trois frères
Frankfurter Kranzform
Tourtière trois frères
Molde trois frères

art.	Ø cm.	h. cm.
47713-22	22	5,5



Gugelhupf cake pan

Stampo americano
Gugelhupfppform
Moule à gugelhupf
Molde gugelhupf

art.	Ø cm.	h. cm.
47705-22	22	10



Loaf pan

Tortiera rettangolare
Königskuchenform
Cake embouti
Molde rectangular

art.	dim. cm.
47714-26	26x9,5x7,5
47714-28	28x10x7,5



Rectangular mold, loose plate bottom

Tortiera, fondo mobile
Backform, gerippt, Heheboden
Tourtière cannelée, fond amovible
Molde fondo desmontable

art.	dim. cm.
47717-35	35x11x2,5



Square mold, fluted, loose bottom

Tortiera festonata, fondo mobile
Tortenform, gewellter Rand, Heheboden
Tourtière carrée, cannelée, fond amovible
Molde cuadrado, rizado, fondo desmontable

art.	dim. cm.
47738-23	23x23x2,5



Baking mold Daisy

Tortiera margherita
Margheriten-Backform
Moule à marguerite
Molde margarita

art.	Ø cm.	h. cm.
47718-20	20	6



Round mold, fluted, loose bottom

Tortiera festonata, fondo mobile
Tortenform, gewellter Rand, Heheboden
Tourtière cannelée, fond amovible
Molde acanalado, fondo desmontable

art.	Ø cm.	h. cm.	U. Pack
47719-10	10	3	6
47719-24	25	5	1



Round mold, fluted, loose bottom

Tartelletta festonata, fondo mobile
Runde, gewellte Tortellets, Heheboden
Tartelette ronde cannelée, fond amovible
Molde redondo rizado, fondo desmontable

art.	Ø cm.	h. cm.	U. Pack
47758-10	10	1,8	6
47758-12	12	2,0	6



Charlotte mold

Charlotte
Charlotte-Form
Charlotte
Molde Charlotte

art.	Ø cm.	h. cm.	U. Pack
47734-18	18	10	6



Bavaoise mold

Bavarese
Bayerische-Kuchenform
Moule Bavaoise
Molde Bávaro

art.	Ø cm.	h. cm.
47735-18	18	9



Rectangular cake mold

Tortiera rettangolare
Königskuchenform
Cake évasé
Molde ensanchado

art.	dim. cm.
47733-18	18x7,5x6,5
47733-24	24x9x7,5
47733-30	30x10x8
47733-36	36x10,5x8



Folding loaf pan

Tortiera rettangolare apribile
Aufklappbare-Königskuchenform
Cake ouvrant
Molde rectangular desmontable

art.	dim. cm.
47715-30	30x10x7,5





Loaf pan with hinges, loose bottom
Bacinella paté con cerniera, fondo mobile
Springkastenform, Heheboden
Pâté à charnière, fond démontable
Molde con bisagra, fondo desmontable

art.	dim. cm.
47736-30	30x8x8
47736-35	35x8x8
47736-40	40x8x8
47736-50	50x8x8



Mini paté mold
Stampo mini-paté
Pastetenkastenform
Mini-pâté à croûte
Molde minipaté

art.	dim. cm.
47018-30	30x4x6
47018-50	50x4x6



Loaf pan
Stampo carré
Königskuchenform
Cake évasé
Molde ensanchado

art.	dim. cm.
47752-16	14x6,5x4
47752-21	17x9,5x5,5



Fluted loaf pan
Stampo carré, fondo festonato
Königskuchenform, gerippt
Cake évasé, fond cannelé
Molde ensanchado, fondo rizado

art.	dim. cm.
47753-31	31x12x5



Baguette baking pan
Teglia baguettes
Baguetteform
Plaque à baguettes
Placa para baguettes

art.	dim. cm.
47014-35	35x24,5x2,5



Oval aspic mold
Aspic ovale
Ovale Aspikform
Aspic ovale
Molde oval

art.	dim. cm.	U. Pack
47726-07	7,5x5,5x3,8	6



Oval aspic mold, star bottom
Aspic ovale, fondo stella
Ovale Aspikform, Sternboden
Aspic ovale, étoilé
Molde oval, fondo estrella

art.	dim. cm.	U. Pack
47727-07	7,5x5,5x3,8	6



Rum baba mold
Stampo babà
Runde Babaform
Dariole embouti
Molde para babà

art.	Ø cm.	h. cm.	U. Pack
47728-06	6	6	6



Oak leaf tart mold
Tartelletta foglia di quercia
Törtchenform Eichenblatt
Tartelette feuille chêne
Molde pasteles

art.	Ø cm.	h. cm.	U. Pack
47759-12	12	2	6



Savarin mold
Tartelletta savarin
Savarinförmchen
Savarin
Molde savarin

art.	Ø cm.	h. cm.	U. Pack
47757-65	6,5	1,5	6
47757-80	8,0	2,0	6



Oval boat mold
Tartelletta barchetta
Schiffchenförmchen
Barquette unie
Molde barquilla

art.	dim. cm.	U. Pack
47720-06	6x2x1	6
47720-08	8x3,3x1,2	6
47720-10	10x4,3x1,3	6
47720-12	12x5x1,3	6



Fluted oval boat mold
Tartelletta barchetta, festonata
Schiffchenförmchen, gerippt
Barquette, cannelée
Molde barquilla, rizado

art.	dim. cm.	U. Pack
47721-08	8x4x1,2	6
47721-10	10x4,5x1,2	6
47721-12	12x5x1,4	6





Round plain mold

Tartelletta tonda
Backförmchen, rund
Tartelette ronde, unie
Molde redondo

art.	Ø cm.	U. Pack
47722-05	5	6
47722-06	6	6
47722-07	7	6
47722-08	8	6
47722-10	10	6



Round fluted mold

Tartelletta tonda festonata
Backförmchen, rund, gerippt
Tartelette ronde, cannelée
Molde redondo, rizado

art.	Ø cm.	U. Pack
47723-05	5	6
47723-06	6	6
47723-07	7	6
47723-08	8	6
47723-10	10	6
47723-12	12	6



Brioche mold

Tartelletta a brioche
Brioche-Förmchen
Tartelette brioche
Molde brioche

art.	Ø cm.	U. Pack
47724-06	6	6
47724-08	8	6
47724-10	10	6
47724-11	11	6



Box of small assorted molds

Scatola tartelletta assortite
Satz Förmchen
Boîte petits fours, assortis
Surtido moldes

art.	pcs/pz
47730-60	60



Friand mold

Tartelletta rettangolare
Friand-Förmchen
Friand
Molde rectangular

art.	dim. cm.	U. Pack
47725-09	10x5x1,4	6



Small mold

Tartelletta
Törtchenform
Petit four
Molde pasteles

art.	dim. cm.	U. Pack
47747-03	4,5x3	6



Small mold

Tartelletta
Törtchenform
Petit four
Molde pasteles

art.	dim. cm.	U. Pack
47747-06	6x3	6



Small mold

Tartelletta
Törtchenform
Petit four
Molde pasteles

art.	Ø cm.	h. cm.	U. Pack
47747-10	4,0	1,0	6
47747-11	3,5	1,4	6



Small mold

Tartelletta
Törtchenform
Petit four
Molde pasteles

art.	Ø cm.	U. Pack
47747-01	4,5	6



Small mold

Tartelletta
Törtchenform
Petit four
Molde pasteles

art.	dim. cm.	U. Pack
47747-04	3,5x3,5	6



Small mold
Tartelletta
Törtchenform
Petit four
Molde pasteles

art.	dim. cm.	U. Pack
47747-07	6x3	6



Small mold
Tartelletta
Törtchenform
Petit four
Molde pasteles

art.	dim. cm.	U. Pack
47747-05	4,5x2,5	6



Small mold
Tartelletta
Törtchenform
Petit four
Molde pasteles

art.	dim. cm.	U. Pack
47747-09	5x3	6



Madeleine sheet
Stampo per madeleines
Madeleine-Backblech
Plaque madeleines
Molde Madeleine

art.	dim. cm.
47731-12	26x20

Pcs/Pz 12 - 7x4,2 cm.



Madeleine sheet
Stampo per madeleinettes
Madeleine-Backblech
Plaque madeleinettes
Molde Madeleine

art.	dim. cm.
47732-20	39,5x12,5

Pcs/Pz 20 - 4,2x3 cm.



Cup bun pan
Stampo tartelletta
Backblech
Plaque tartelletes
Molde pasteles

art.	dim. cm.
47748-35	31,5x24x1,2

Top Ø 68 - bottom Ø 45 - H 10 mm.



Snowman mold
Stampo pupazzo di neve
Schneemann-Backblech
Plaque bonhomme de neige
Molde muñeco de nieve

art.	dim. cm.
47762-23	23x5



Christmas style mold
Stampo di Natale
Weihnachts-Backblech
Plaque de Noël
Molde de Noel

art.	dim. cm.
47750-06	31,5x21,5x2,5



Santa Claus mold
Stampo Babbo Natale
Weihnachtsmann-Backblech
Plaque Père Noël
Molde Papà Noel

art.	dim. cm.
47761-23	23x4,8



Easter muffin pan
Stampo motivi pasquali
Ostern-Backblech
Plaque Pâque
Molde Pascua

art.	dim. cm.
47749-35	35x27x3



Egg mold
Stampo uovo
Ostereierform
Moule à oeuf
Molde para huevos

art.	dim. cm.
47007-26	26x8,3



Easter rabbit mold
Stampo coniglietto di Pasqua
Osternhase-Backblech
Plaque lapin de Pâque
Molde conejo de Pascua

art.	dim. cm.
47764-12	12x2,6





Easter rabbit mold

Stampo coniglio di Pasqua
Osternhase-Backblech
Plaque lapin de Pâque
Molde conejo de Pascua

art.	dim. cm.
47764-28	28x5,4



Fluted springform pan

Tortiera a ciambella apribile
Savarinspringform
Moule à manqué savarin démontable
Molde savarin desmontable

art.	Ø cm.	h. cm.
47756-20	20,5	4,7
47756-24	24,0	6,8
47756-26	26,0	6,5
47756-28	28,0	6,7



Springform pan

Tortiera apribile
Springform
Manqué à manqué démontable
Molde desmontable

art.	Ø cm.	h. cm.
47754-20	20,5	6,5
47754-24	24,0	6,5
47754-26	26,0	6,5
47754-28	28,0	6,7



Springform pan with 6 bottoms

Tortiera apribile, 6 fondi
Springform mit 6 Böden
Moule à manqué démontable 6 fonds
Molde desmontable, 6 fondos

art.	Ø cm.	h. cm.
47755-26	26	6



Log mold, plastic

Stampo per tronco, plastica
Kastenform, Kunststoff
Gouttière, plastique
Molde, plástico

art.	dim. cm.
47659-01	48x6,5x6,5
47659-02	48x6,5x5
47659-04	48x5,0x4



Comb for Charlotte with frame

Pettine Charlotte con telaio
Charlotte-Kamme mit Rahmen
Peigne à Charlotte avec cadre
Peine para Charlotte con marco

art.	dim. cm.
47670-02	57x36,5



Comb with 5 rubber blades

Pettine con 5 fasce gomma
Kamm mit 5 Gummiklingen
Peigne avec 5 bandes à décor
Peine con 5 láminas de goma

art.	dim. cm.
47672-05	70x10

SS

SS

MONOPORTION TRAY MOLDS
TEGLIE MONOPORZIONI



Tray cm. 60x40

Teglia
Blech
Plaque
Bandeja

art.	dim. mm.	pcs/pz	gr.
47651-01	Ø 44 h 25	96	20
47651-02	55x35x25	96	20
47651-03	46x46x25	96	20
47651-04	60x38x25	96	20
47651-05	58x39x25	96	20
47651-07	38x38x25	96	20

Extractor

Estrattore
Extraktor
Extracteur
Extractor

art.	dim. mm.
47656-01	Ø 44 h 25
47656-02	55x35x25
47656-03	46x46x25
47656-04	60x38x25
47656-05	58x39x25
47656-07	38x38x25



Cutter

Tagliapasta
Ausstechform
Coupe-pâte
Cortador

art.	dim. mm.
47655-01	Ø 44 h 25
47655-02	55x35x25
47655-03	46x46x25
47655-04	60x38x25
47655-05	58x39x25
47655-07	38x38x25

Tray cm. 60x40

Teglia
Blech
Plaque
Bandeja

art.	dim. mm.	pcs/pz	gr.
47652-01	Ø 67 h 40	35	75
47652-02	86x50x40	35	75
47652-03	74x71x40	35	75
47652-04	90x58x40	35	75
47652-05	88x60x40	35	75
47652-07	59x59x40	35	75



Estrattore

Estrattore
Extraktor
Extracteur
Extractor

art.	dim. mm.
47658-01	Ø 67 h 40
47658-02	86x50x40
47658-03	74x71x40
47658-04	90x58x40
47658-05	88x60x40
47658-07	59x59x40

Cutter

Tagliapasta
Ausstechform
Coupe-pâte
Cortador

art.	dim. mm.
47657-01	Ø 67 h 40
47657-02	86x50x40
47657-03	74x71x40
47657-04	90x58x40
47657-05	88x60x40
47657-07	59x59x40



PRALINE'S SILICONE MOLDS CM 19X29
STAMPI IN SILICONE PER PRALINE CM 19X29



Practical, flexible and resistant silicone molds for sweet or salty creations (snaks, truffles, jellies, pralines). Perfect to make large quantities in short time. They withstand from -40° to +250°C. Can be used in the oven, refrigerator and blast chiller.

Pratici stampi in silicone flessibili e resistenti per creazioni dolci o salate (snack, tartufi, gelatine, praline). Ideali per realizzare grandi quantità in poco tempo. Resistono da -40° a +250°C. Utilizzabili in forno, frigorifero e abbattitore.

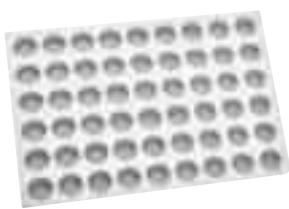

Chocoflex - psc/pz 54

art.	Ø mm.	h.
47783-01	26	14

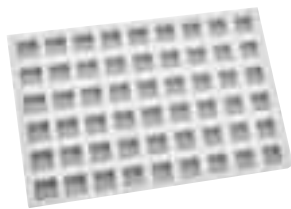

Chocoflex - psc/pz 54

art.	dim. mm.
47783-02	23x23x14

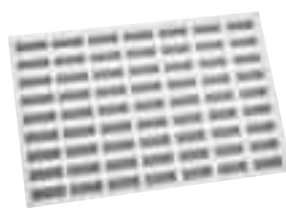

Chocoflex - psc/pz 63

art.	dim. mm.
47783-03	35x14,5x14

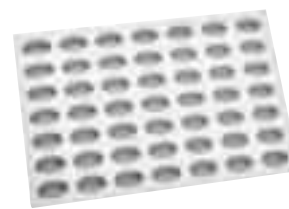

Chocoflex - psc/pz 49

art.	dim. mm.
47783-04	32x21x14

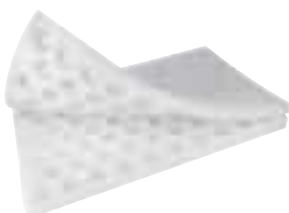

Chocoflex - psc/pz 54

art.	Ø mm.	h.
47783-11	26	14



Chocoflex - psc/pz 40

art.	Ø mm.	h.
47783-12	30-10	12



Chocoflex - psc/pz 15

art.	dim. mm.
47783-13	90x30x19



Chocoflex - psc/pz 15

art.	dim. mm.
47783-14	90x30x19

CHOCOLATE
CIOCCOLATO

PC



Polycarbonate chocolate molds. Mold size 17,5x27,5 cm.

Stampi policarbonato. Misure stampo 17,5x27,5 cm.

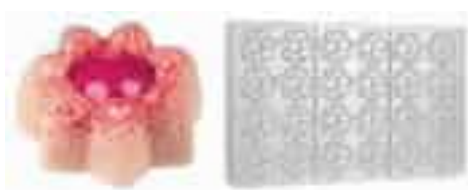

NEW



NEW

Chocolate/Cioccolato Praline

art.	Ø mm.	h.	pcs/pz	gr.
47861-25	35	16	24	11

Chocolate/Cioccolato Praline

art.	dim. mm.	pcs/pz	gr.
47861-26	27x27x16	28	11



NEW



NEW

Chocolate/Cioccolato Praline

art.	dim. mm.	pcs/pz	gr.
47861-20	29x29x18	24	11

Chocolate/Cioccolato Praline

art.	dim. mm.	pcs/pz	gr.
47861-21	30x31x18	24	11



NEW



NEW

Chocolate/Cioccolato Praline

art.	dim. mm.	pcs/pz	gr.
47861-27	40x19x16	25	10

Chocolate/Cioccolato Praline

art.	dim. mm.	pcs/pz	gr.
47861-28	39,5x19x16	25	11



NEW



NEW

Chocolate/Cioccolato Praline

art.	dim. mm.	pcs/pz	gr.
47861-29	40x18x16	25	11

Chocolate/Cioccolato Praline

art.	dim. mm.	pcs/pz	gr.
47861-30	40,5x18x16	25	10





NEW

Chocolate/Ciocolato Praline

art.	Ø mm.	h.	pcs/pz	gr.
47861-31	32	21	25	11



NEW

Chocolate/Ciocolato Praline

art.	Ø mm.	h.	pcs/pz	gr.
47861-32	32	19,5	25	11



Chocolate/Ciocolato Praline

art.	dim. mm.	pcs/pz
47861-02	50x25x15	21



Chocolate/Ciocolato Praline

art.	dim. mm.	pcs/pz
47861-03	30x30x8	24



Chocolate/Ciocolato Praline

art.	Ø mm.	h.	pcs/pz
47861-04	35	8	24



Chocolate/Ciocolato Praline

art.	dim. mm.	pcs/pz
47861-05	33x33x15	24



Chocolate/Ciocolato Praline

art.	dim. mm.	pcs/pz
47861-07	39x18x15,5	30
47861-08	96x22x15,5	10



Chocolate/Ciocolato Praline

art.	dim. mm.	pcs/pz
47861-09	39x18x15,5	30
47861-10	96x22x17	10



Chocolate/Ciocolato Praline

art.	dim. mm.	pcs/pz
47861-11	39x20x16	27
47861-06	96x22x17	10



Chocolate/Ciocolato Praline

art.	dim. mm.	pcs/pz
47861-12	52x26x14	21



Chocolate/Ciocolato Praline

art.	dim. mm.	pcs/pz
47861-13	42x25x6	20



Chocolate/Ciocolato Praline

art.	dim. mm.	pcs/pz
47861-14	123x27x12	8



Chocolate/Ciocolato Praline

art.	dim. mm.	pcs/pz
47861-15	138x72x11	3



Chocolate/Ciocolato Praline

art.	dim. mm.	pcs/pz
47860-17	30x30x12	24



Chocolate/Ciocolato Praline

art.	Ø mm.	h.	pcs/pz
47860-18	27	17	24



Chocolate/Ciocolato Praline

art.	Ø mm.	h.	pcs/pz
47860-21	29	18	24



Chocolate/Ciocolato Praline

art.	dim. mm.	pcs/pz
47860-24	40x42x15	15



Chocolate/Ciocolato Praline

art.	dim. mm.	pcs/pz
47860-27	27x27x13	28



Chocolate/Ciocolato Praline

art.	dim. mm.	pcs/pz
47860-31	33x25x12	24



Chocolate/Ciocolato Praline

art.	Ø mm.	h.	pcs/pz
47860-35	30	19	28



Chocolate/Ciocolato Praline

art.	dim. mm.	h.	pcs/pz
47860-36	25x25x25	25	40



Chocolate/Ciocolato Praline

art.	dim. mm.	pcs/pz
47860-37	36x22x20	36



Chocolate/Ciocolato Praline

art.	dim. mm.	pcs/pz
47860-38	48x18,5x19	16



Chocolate/Ciocolato Praline

art.	dim. mm.	pcs/pz
47860-39	30x18x15	30



Chocolate/Ciocolato Praline

art.	Ø mm.	h.	pcs/pz
47860-40	29	21	40



Chocolate/Ciocolato Praline

art.	dim. mm.	pcs/pz
47860-42	35x23x16	36



Chocolate/Ciocolato Praline

art.	dim. mm.	pcs/pz
47860-43	38x28x18	30



Chocolate/Ciocolato Praline

art.	dim. mm.	pcs/pz
47860-44	28x32x15	32



Chocolate/Ciocolato Praline

art.	dim. mm.	pcs/pz
47860-46	35x20x17	30



Chocolate/Ciocolato Praline

art.	Ø mm.	h.	pcs/pz
47860-48	28	24	40



Chocolate/Ciocolato Praline

art.	Ø mm.	h.	pcs/pz
47860-49	30	22	28



Chocolate/Ciocolato Praline

art.	Ø mm.	h.	pcs/pz
47860-50	26	15	35



Chocolate/Ciocolato Praline

art.	dim. mm.	pcs/pz
47860-53	22x22x22	28



Chocolate/Ciocolato Praline

art.	dim. mm.	pcs/pz
47860-55	26x20x21	28



Chocolate/Ciocolato Praline

art.	Ø mm.	h.	pcs/pz
47860-56	24	21	28





Chocolate/Ciocolato Praline

art.	dim. mm.	pcs/pz
47860-58	17x12x5	130



Chocolate/Ciocolato Praline

art.	Ø mm.	h.	pcs/pz
47860-60	25	18,5	28



Chocolate/Ciocolato Praline

art.	dim. mm.	pcs/pz
47860-61	30x20x17,5	28



Chocolate/Ciocolato Praline

art.	Ø mm.	h.	pcs/pz
47860-62	27	20	30



Chocolate/Ciocolato Praline

art.	Ø mm.	h.	pcs/pz
47860-63	27	20	30



Chocolate/Ciocolato Praline

art.	dim. mm.	pcs/pz
47860-66	25x25x15	30



Chocolate/Ciocolato Praline

art.	dim. mm.	pcs/pz
47860-67	25x25x15	30



Chocolate/Ciocolato Praline

art.	Ø mm.	h.	pcs/pz
47860-68	28	25	40



Chocolate/Ciocolato Praline

art.	dim. mm.	pcs/pz
47860-69	40x20x18	30



Chocolate/Ciocolato Praline

art.	dim. mm.	pcs/pz
47860-73	31x22x22	5x6



Chocolate/Ciocolato Praline

art.	dim. mm.	pcs/pz
47860-71	26x26x20	30

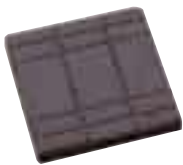

Chocolate/Ciocolato Praline

art.	dim. mm.	pcs/pz
47860-74	32x32x4	24



Chocolate/Ciocolato Praline

art.	dim. mm.	pcs/pz
47860-70	40x18x15	30



Chocolate/Ciocolato Praline

art.	dim. mm.	pcs/pz
47860-75	20x20x16	28



Chocolate/Ciocolato Praline

art.	dim. mm.	pcs/pz
47860-81	30x18x15	30



Chocolate/Ciocolato Praline

art.	dim. mm.	pcs/pz
47860-83	30x30x15	24



Chocolate/Ciocolato Praline

art.	Ø mm.	h.	pcs/pz
47860-84	26	19	35



Chocolate/Ciocolato Praline

art.	dim. mm.	pcs/pz
47860-85	35x22x16	35



Chocolate/Ciocolato Praline

art.	dim. mm.	pcs/pz
47860-95	25x25x13	24



Chocolate/Ciocolato Praline

art.	Ø mm.	h.	pcs/pz
47860-96	35	15	24



Chocolate/Ciocolato Praline

art.	dim. mm.	pcs/pz
47862-31	28x28x16	28



Chocolate/Ciocolato Praline

art.	dim. mm.	pcs/pz
47862-32	24x24x18	28



Chocolate/Ciocolato Praline

art.	dim. mm.	pcs/pz
47862-33	40x42x16	15



Chocolate/Ciocolato Praline

art.	dim. mm.	pcs/pz
47862-34	41x24x20	20



Chocolate/Ciocolato Praline

art.	dim. mm.	pcs/pz
47862-35	30x30x11	28



Chocolate/Ciocolato Praline

art.	dim. mm.	pcs/pz
47862-36	35x23x17	24



Chocolate/Ciocolato Praline

art.	dim. mm.	pcs/pz
47860-89	27x27x20	28



Chocolate/Ciocolato Praline

art.	Ø mm.	h.	pcs/pz
47860-97	23	29	28



Chocolate/Ciocolato Praline

art.	Ø mm.	h.	pcs/pz
47860-98	23	28,5	28



Chocolate/Ciocolato Praline

art.	dim. mm.	pcs/pz
47860-99	75x70x22	6



Chocolate mini bars/Mini barrette

art.	dim. mm.	pcs/pz
47862-38	50x26x3	16



Chocolate mini bars/Mini barrette

art.	dim. mm.	pcs/pz
47862-39	74x33x5	12





Chocolate bars 3 pcs

Tavolette cioccolato 3 pz
Schokoladentafel 3 Stk
Tablettes chocolat 3 pcs
Tabletas chocolate 3 pz

art.	dim. mm.	gr.
47870-50	140x69,5x11	100



Chocolate bars 3 pcs

Tavolette cioccolato 3 pz
Schokoladentafel 3 Stk
Tablettes chocolat 3 pcs
Tabletas chocolate 3 pz

art.	dim. mm.	gr.
47870-51	138x68x11	100



Chocolate bars 3 pcs

Tavolette cioccolato 3 pz
Schokoladentafel 3 Stk
Tablettes chocolat 3 pcs
Tabletas chocolate 3 pz

art.	dim. mm.	gr.
47870-52	140x70,5x10	100



Chocolate bars 3 pcs

Tavolette cioccolato 3 pz
Schokoladentafel 3 Stk
Tablettes chocolat 3 pcs
Tabletas chocolate 3 pz

art.	dim. mm.	gr.
47870-53	139x69,5x11,5	100



NEW

Chocolate/Ciocolato Praline

art.	dim. mm.	pcs/pz	gr.
47861-23	97x64x130	1	110



NEW

Chocolate/Ciocolato Praline

art.	dim. mm.	pcs/pz	gr.
47861-24	70x66x20	6	14



NEW

Chocolate/Ciocolato Praline

art.	dim. mm.	pcs/pz	gr.
47861-22	78x73x150	1	130



NEW

Chocolate/Ciocolato Praline

art.	Ø mm.	h.	pcs/pz	gr.
47861-33	75	120	2	45



NEW

Chocolate/Ciocolato Praline

art.	Ø mm.	h.	pcs/pz	gr.
47861-34	70	120	2	55



Polycarbonate molds mm. 275x175. To create small mignon and refined pralines with an original and inviting look.

Stampi in policarbonato mm. 275x175 . Per creare piccoli mignon e raffinate praline dall'aspetto originale e invitante.



Mini choco fill

art.	Ø mm.	h.	pcs/pz
47862-64	27	31	28



Mini choco fill

art.	Ø mm.	h.	pcs/pz
47862-65	37	14	15



Mini choco fill

art.	dim. mm.	pcs/pz
47862-66	27x27x31	28



Mini choco fill

art.	dim. mm.	pcs/pz
47862-67	33x33x14	24



Mini choco fill

art.	dim. mm.	pcs/pz
47862-03	32x24x29	24



Mini choco fill

art.	dim. mm.	pcs/pz
47862-04	44x56x39	12



Mini choco fill

art.	Ø mm.	h.	pcs/pz
47862-05	40	17	15





Mini choco fill

art.	dim. mm.	pcs/pz
47862-06	33x31x20	24



Mini choco fill

art.	dim. mm.	pcs/pz
47862-07	33x33x23	24



Mini choco fill

art.	dim. mm.	pcs/pz
47862-08	44x55x23	12



Mini choco fill

art.	Ø mm.	h.	pcs/pz
47862-09	40	18,5	15



Mini choco fill

art.	Ø mm.	h.	pcs/pz
47862-10	32	37	20



Tray/Vassoio

art.	dim. cm.	pcs/pz
47862C10	38x10x2,5	20



Chocolate/Ciocolato Decoration

art.	dim. mm.	pcs/pz	gr.
47862-70	64x26	16	2/3



Chocolate/Ciocolato Decoration

art.	dim. mm.	pcs/pz	gr.
47862-72	110x7	22	3/4



Chocolate/Ciocolato Decoration

art.	dim. mm.	pcs/pz	gr.
47862-74	65x22	18	2/3



Letters & Numbers

art.	h. cm.
47860-86	3

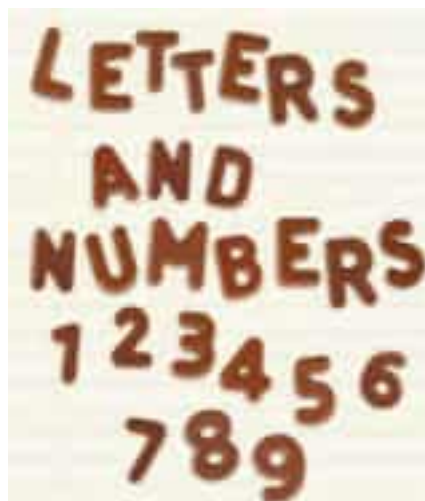

Hemispheres/Semisfere

art.	Ø mm.	pcs/pz
47861-16	20	45
47860-76	30	24



Hemispheres/Semisfere

art.	Ø mm.	pcs/pz
47861-17	40	15



Hemispheres/Semisfere

art.	Ø mm.	pcs/pz
47860-77	50	8



Hemispheres/Semisfere

art.	Ø mm.	pcs/pz
47861-18	60	6



Hemispheres/Semisfere

art.	Ø mm.	pcs/pz
47861-19	80	4



Hemispheres/Semisfere

art.	Ø mm.	pcs/pz
47860-78	100	2



Egg mold kit

Stampo uovo kit
Ostereierform-Kit
Moule à oeuf en kit
Molde huevo

art.	Ø mm.	h.	pcs/pz	gr.
47862-88	115	155	2	230

Thermoformed plastic. – Plastica termoformata.



Egg mold kit

Stampo uovo kit
Ostereierform-Kit
Moule à oeuf en kit
Molde huevo

art.	Ø mm.	h.	pcs/pz	gr.
47862-87	120	185	2	280

Thermoformed plastic. – Plastica termoformata.



Egg mold kit

Stampo uovo kit
Ostereierform-Kit
Moule à oeuf en kit
Molde huevo

art.	Ø mm.	h.	pcs/pz	gr.
47862-89	122	185	2	270

Thermoformed plastic. – Plastica termoformata.





Half egg mold, PETG

Stampo mezzo uovo
Halbe Eierform
Moule demi oeuf
Molde medio huevo

art.	dim. cm.	Kg.
47876-11	17x25	0,5-1,0
47876-12	18x28	0,8-1,2
47876-13	34x25	1,5-2,0
47876-14	27x40	2,0-2,5



PC

Half egg mold

Stampo mezzo uovo
Halbe Eierform
Moule demi oeuf
Molde medio huevo

art.	dim. mm.	pcs/pz	gr.
47862-80	44x64	10	25



PC

Half egg mold

Stampo mezzo uovo
Halbe Eierform
Moule demi oeuf
Molde medio huevo

art.	dim. mm.	pcs/pz	gr.
47862-81	75x105	4	70



PC

Half egg mold

Stampo mezzo uovo
Halbe Eierform
Moule demi oeuf
Molde medio huevo

art.	dim. mm.	pcs/pz	gr.
47862-82	90x130	2	150
47862-83	104x150	2	230



PC

Half egg mold

Stampo mezzo uovo
Halbe Eierform
Moule demi oeuf
Molde medio huevo

art.	dim. mm.	pcs/pz	gr.
47862-84	121x175	1	260
47862-85	141x204	1	380
47862-86	157x227	1	430



PE

Egg mold, PET

Stampo uovo
Ostereierform
Moule à oeuf
Molde para huevos

art.	dim. mm.	pcs/pz
47865-44	220x160x85	1
47865-23	110x80x40	2
47865-80	112x83x44	2
47865-81	125x94x44	2
47865-82	140x100x50	2
47865-83	154x110x55	2



PE

Egg mold, PET

Stampo uovo
Ostereierform
Moule à oeuf
Molde para huevos

art.	dim. mm.	pcs/pz
47865-66	80x60x25	4
47865-73	40x31x17	14
47865-71	36x23x12	18



PE

Egg mold, PET

Stampo uovo
Ostereierform
Moule à oeuf
Molde para huevos

art.	dim. mm.	pcs/pz
47865-74	64x44x26	6
47865-72	39x25x13	14



PE

Egg mold, PET

Stampo uovo
Ostereierform
Moule à oeuf
Molde para huevos

art.	dim. mm.	pcs/pz
47865-77	140x100x49	1
47865-76	95x70x40	2
47865-75	83x54x24	4

MAGNETIC MOLDS - STAMPI MAGNETICI

NEW PC

Thematic polycarbonate molds - mm 275x175 - with magnets to join the two halves and produce 3D chocolate subjects.

Stampi tematici in polycarbonato - mm 275x175 - con calamite per unire le due metà e realizzare soggetti 3D in cioccolato.



Egg/Uovo

art.	Ø mm.	h.	pcs/pz	gr.
47863-10	104	150	2	230
47863-11	120	175	1	260
47863-12	141	204	1	380
47863-13	160	230	1	430



Tree/Albero

art.	Ø mm.	h.	pcs/pz	gr.
47863-14	110	152	2	200



Tree/Albero

art.	Ø mm.	h.	pcs/pz	gr.
47863-25	58	100	5	100



Reindeer/Renna

art.	dim. mm.	pcs/pz	gr.
47863-16	88x56x120	2	70



Reindeer/Renna

art.	dim. mm.	pcs/pz	gr.
47863-23	46x45x100	4	68



Reindeer/Renna

art.	dim. mm.	pcs/pz	gr.
47863-24	43x43x120	4	65



Rooster/Gallo

art.	dim. mm.	pcs/pz	gr.
47863-20	100x160x126	2	115



Hen/Gallina

art.	dim. mm.	pcs/pz	gr.
47863-21	94x108x106	4	75



Chick/Pulcino

art.	dim. mm.	pcs/pz	gr.
47863-22	65x84x80	6	45



Ball/Palla

art.	Ø mm.	h.	pcs/pz	gr.
47863-17	62	72	6	50



Soldier/Soldato

art.	dim. mm.	pcs/pz	gr.
47863-15	53x44x120	4	35



Santa Claus/Snowman

art.	dim. mm.	h.	pcs/pz
47863-26	46	79	4
	42x16	72	4



3D HOLLOW MOLDS/STAMPI 3D CORPO CAVO - PETG
3D-HOHLFORME/MOULES CREUSES 3D/MOLDE 3D



Easter/Pasqua

art.	h. mm.
47793-12	180



Easter/Pasqua

art.	h. mm.
47793-13	140



Easter/Pasqua

art.	h. mm.	#
47793-15	170	2



Easter/Pasqua

art.	h. mm.	#
47793-23	110	3



Christmas/Natale

art.	h. mm.
47793-33	180



Christmas/Natale

art.	h. mm.
47793-40	168



Easter/Pasqua

art.	h. mm.
47793-26	110



Christmas/Natale

art.	h. mm.	#
47793-43	114	3



Christmas/Natale

art.	h. mm.
47793-45	135



Ball/Pallone

art.	h. mm.
47793-52	120



Shoe/Scarpa

art.	dim. mm.
47793-55	220x75x170



FRUITS/TUTTIFRUTTI CM 40X30

Silicone molds cm 40x30, to create original dessert and surprising monoportions.

Stampi in silicone cm 40x30, per realizzare dessert al piatto e monoportzioni.



Pear

Pera

art.	Ø mm.	h.	ml.	pcs/pz
47745-06	53	70	90	20



Apple

Mela

art.	Ø mm.	h.	ml.	pcs/pz
47745-07	55	48	90	20



Peach/Cherry

Pesca/Ciliegia

art.	dim. mm.	ml.	pcs/pz
47745-08	58x53x46	90	20



Tangerine

Mandarino

art.	Ø mm.	h.	ml.	pcs/pz
47745-09	57	50	90	20



Strawberry

Fragola

art.	dim. mm.	ml.	pcs/pz
47745-10	71x54x46	90	20



SILICONE MOLDS CM 60X40 - CM 40X30
STAMPI SILICONE CM 60X40 - CM 40X30



Quenelle 60x40

art.	dim. mm.	ml.	pcs/pz
47746-01	66x33x30	32	49



Mini quenelle 60x40

art.	dim. mm.	ml.	pcs/pz
47746-02	42x20x20	8	100



Quenelle 60x40

art.	dim. mm.	ml.	pcs/pz
47746-03	66x35x26	34	49



Mini quenelle 60x40

art.	dim. mm.	ml.	pcs/pz
47746-04	42x22x17	9	100



Sphere 40x30

art.	Ø mm.	ml.	pcs/pz
47745-02	20	4	48



Sphere 40x30

art.	Ø mm.	ml.	pcs/pz
47745-03	30	14	30



Sphere 40x30

art.	Ø mm.	ml.	pcs/pz
47745-04	40	33	24



Sphere 40x30

art.	Ø mm.	ml.	pcs/pz
47745-05	50	65	20

SILICONE MOLDS CM 17,5X30
STAMPI SILICONE CM 17,5X30



100% platinum silicone cake molds, cm 17,5x30 - GN 1/3.
Suitable for freezing and baking (resistance from -40°C up to +280°C). For a correct use, put the moulds on grills or perforated trays, in order to improve the heat diffusion during baking. High non-stick properties to let a perfect demoulding of the product. Can be whashed by hand or in dishwasher. Manufactured in conformity with international regulations concerning food contact: D.M. no. 104 of 21/03/1973 (Italian law) - Arrêté du 25/11/1992 (French law) - BGVV (German law) - FDA (USA law).

Stampi in silicone platinico 100%, cm 17,5x30 - GN 1/3.
 Adatti per la surgelazione e la cottura (resistono da -40°C a +280°C). Per un utilizzo ottimale, posizionare gli stampi su griglie o teglie forate per favorire la diffusione del calore durante la cottura. Elevata antiaderenza per consentire una perfetta sfornatura del prodotto. Lavabili a mano e in lavastoviglie. Conforme alle norme internazionali che regolano l'utilizzo di materiali destinati al contatto con sostanze alimentari: D.M. n. 104 del 21/03/1973 (legislazione italiana) - Arrêté du 25/11/1992 (legislazione francese) - BGVV (legislazione tedesca) - FDA (legislazione statunitense).



Big baba
Babà grande

art.	Ø mm.	h.	ml.	pcs/pz
47742-02	55	60	97	8



Medium baba
Babà medio

art.	Ø mm.	h.	ml.	pcs/pz
47742-30	45	48	51	11



Small baba
Babà piccolo

art.	Ø mm.	h.	ml.	pcs/pz
47742-31	35	38	25	15



Bavarian
Bavarese

art.	Ø mm.	h.	ml.	pcs/pz
47742-41	57	57	110	8



Fluted cake
Briochette cannellata

art.	Ø mm.	h.	ml.	pcs/pz
47742-12	79	30	109	6



Fluted cake
Briochette cannellata

art.	Ø mm.	h.	ml.	pcs/pz
47742-27	79	37	100	6



Cake

Cake

art.	dim. mm.	ml.	pcs/pz
47742-56	80x30x30	62	9



Cannelle

Cannelle

art.	Ø mm.	h.	ml.	pcs/pz
47742-51	56	50	70	8



Cylinder

Cilindro

art.	Ø mm.	h.	ml.	pcs/pz
47742-17	60	35	89	8



Heart

Cuore

art.	dim. mm.	ml.	pcs/pz
47742-25	65x60x35	97	8



Biscuit disc

Disco biscuit

art.	Ø mm.	h.	ml.	pcs/pz
47742-23	103	20	160	3



Florentine

Florentine

art.	Ø mm.	h.	ml.	pcs/pz
47742-19	60	12	27	8



Madeleine

Madeleine

art.	dim. mm.	ml.	pcs/pz
47742-21	68x45x18	30	9
47742-37	42x30x11,5	8	20



Mini cannelle

Mini cannelle

art.	Ø mm.	h.	ml.	pcs/pz
47742-42	35	35	24	18



Mini financier

Mini finanziere

art.	dim. mm.	ml.	pcs/pz
47742-14	49x26x11	11	20



Mini guglhupf

Mini guglhupf

art.	Ø mm.	h.	ml.	pcs/pz
47742-34	60	33	70	6



Mini muffin

Mini muffin

art.	Ø mm.	h.	ml.	pcs/pz
47742-20	50	28	43	11



Mini oval

Mini ovale

art.	dim. mm.	ml.	pcs/pz
47742-09	53x33x20	28	16



Mini pyramid

Mini piramide

art.	dim. mm.	ml.	pcs/pz
47742-13	36x36x22	13	15



Mini savarin
Mini savarin

art.	Ø mm.	h.	ml.	pcs/pz
47742-05	41	12	12	18



Muffin
Muffin

art.	Ø mm.	h.	ml.	pcs/pz
47742-08	70	40	130	6



Muffin
Muffin

art.	Ø mm.	h.	ml.	pcs/pz
47742-33	80	35	110	5



Petit four
Petit four

art.	Ø mm.	h.	ml.	pcs/pz
47742-24	40	20	22	15



Pyramid
Piramide

art.	dim. mm.	ml.	pcs/pz
47742-07	71x71x40	92	6



Pomponette
Pomponette

art.	Ø mm.	h.	ml.	pcs/pz
47742-06	34	16	13	24



Savarin
Savarin

art.	Ø mm.	h.	ml.	pcs/pz
47742-15	72	23	67	6



Savarin
Savarin

art.	Ø mm.	h.	ml.	pcs/pz
47742-10	65	21	49	8



Half sphere
Semisfera

art.	Ø mm.	h.	ml.	pcs/pz
47742-04	30	17	8,5	24



Half sphere
Semisfera

art.	Ø mm.	h.	ml.	pcs/pz
47742-03	40	20	17	15



Half sphere
Semisfera

art.	Ø mm.	h.	ml.	pcs/pz
47742-48	50	23	33	15



Half sphere
Semisfera

art.	Ø mm.	h.	ml.	pcs/pz
47742-47	60	30	57	8



Half sphere
Semisfera

art.	Ø mm.	h.	ml.	pcs/pz
47742-01	70	35	89	6



Half sphere
Semisfera

art.	Ø mm.	h.	ml.	pcs/pz
47742-29	80	40	134	5



Tartlet
Tartelletta

art.	Ø mm.	h.	ml.	pcs/pz
47742-16	50	15	20	15



Cakes
Tortine

art.	Ø mm.	h.	ml.	pcs/pz
47742-61	80	18	85	6



Round cake tin
Tortiera tonda

art.	Ø mm.	h.	ml.
47765-24	240	42	1850
47765-26	260	45	2250
47765-28	280	45	2600



Fluted round cake tin
Tortiera tonda cannellata

art.	Ø mm.	h.	ml.
47766-26	260	30	1350
47766-28	280	30	1600
47766-30	300	30	1850





Tart tin

Crostata

art.	Ø mm.	h.	ml.
47771-28	280	30	1700



Heart cake tin

Tortiera cuore

art.	dim. mm.	ml.
47770-21	220x218x35	1150



Plumcake

Plumcake

art.	dim. mm.	ml.
47773-24	240x105x65	1385
47773-28	280x105x65	1660



Rectangular cake pan

Tortiera rettangolare

art.	dim. mm.	ml.
47769-28	280x240x40	2670



Drainer

Sgocciolatore

art.	dim. cm.
47742-00	30x30x17,5

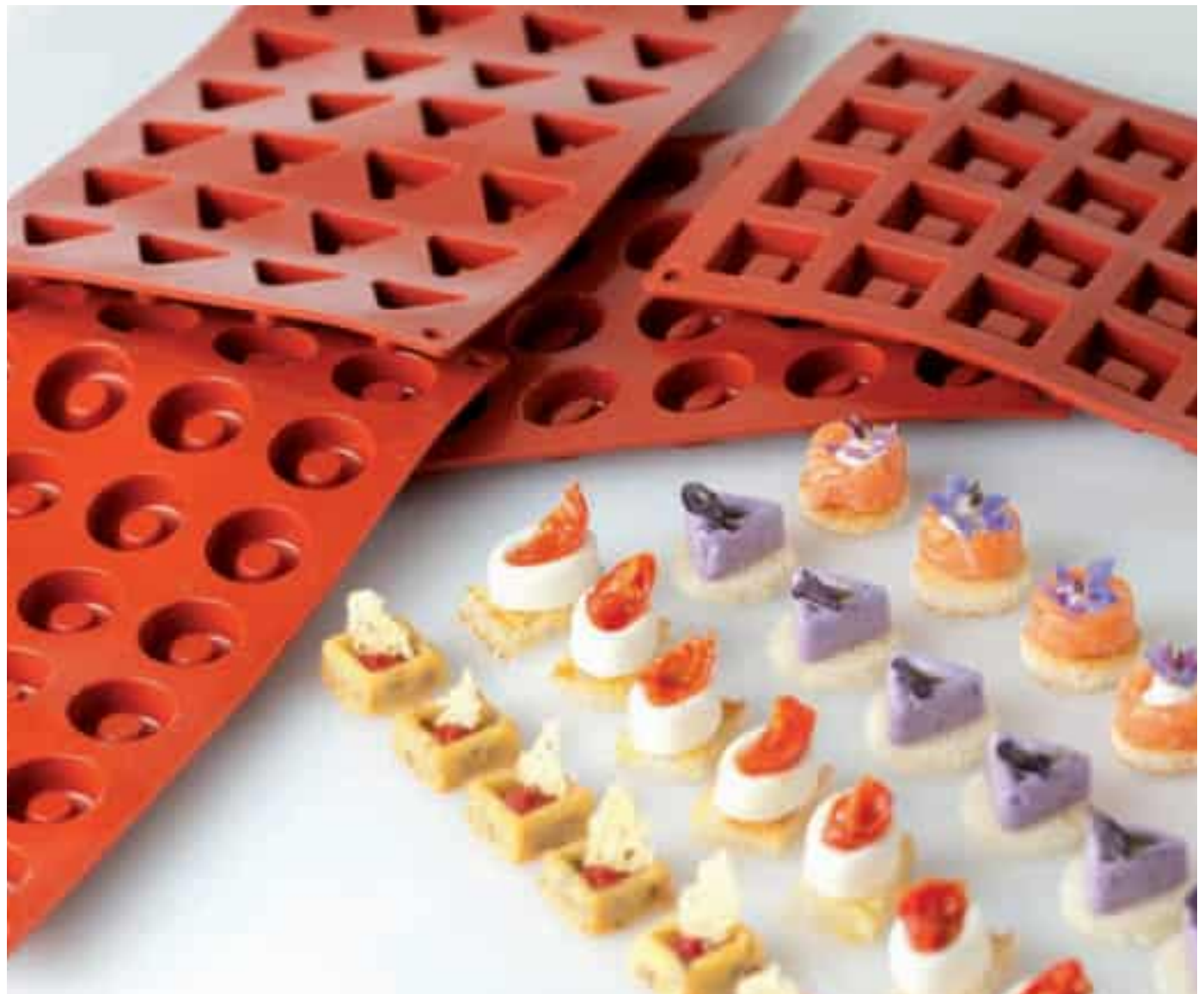
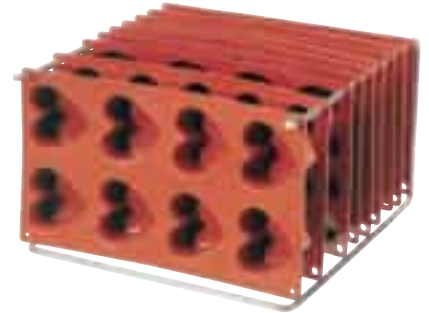

FLEXIPAN® ORIGINE

f FLEXIPAN®

PASTRY
PASTICCERIA

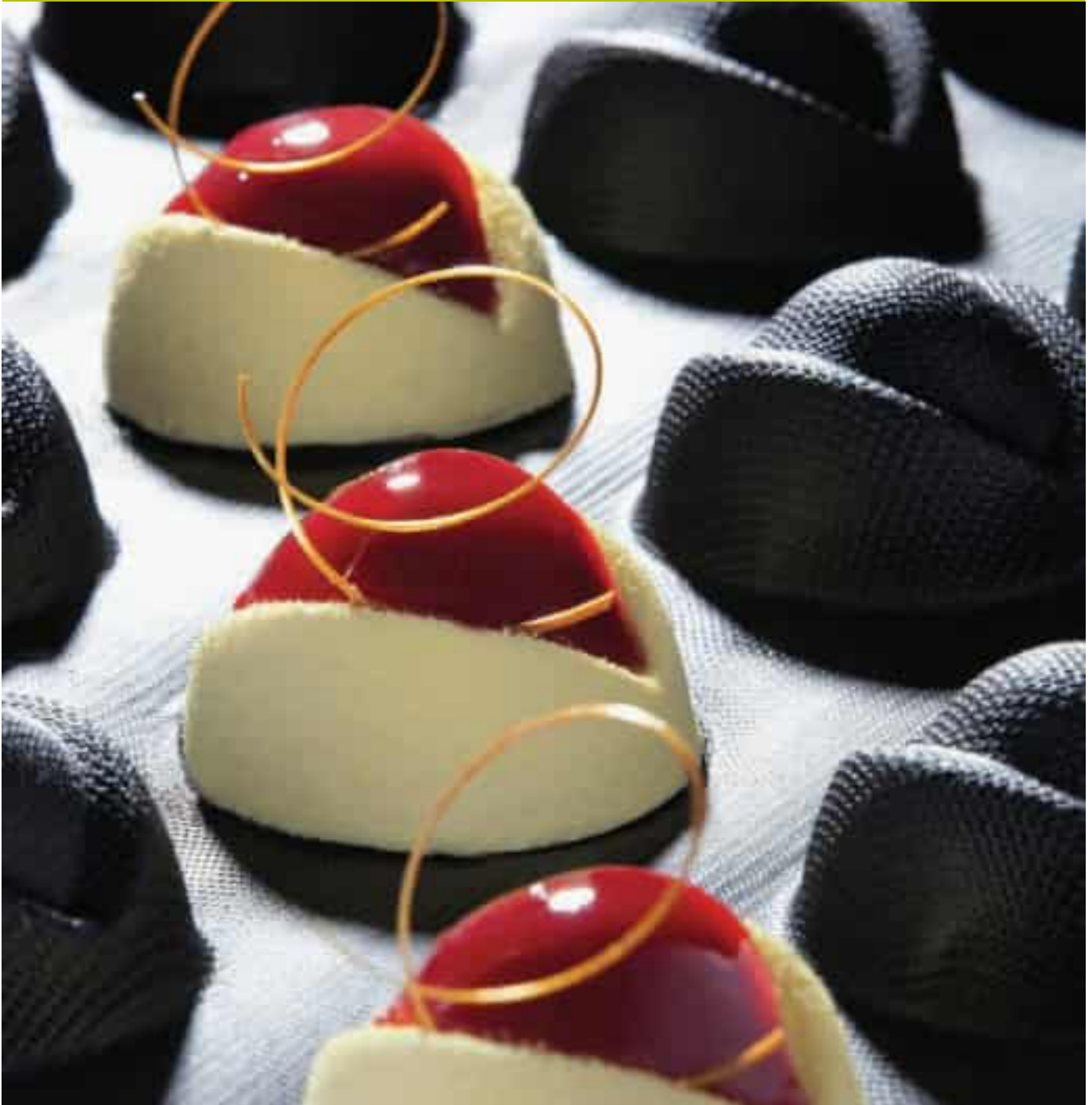

The Sasa Demarle Group is the only company in the world to formulate and produce its own food silicone, specially designed for the bakery and pastry industry. The use of this silicone allows an optimal heat distribution, which offers an even baking and colour, as well as perfect non-stick properties for an easy and perfect demoulding. The Flexipan moulds offer great performances with high lifetime expectancy: from 3,000 to 5,000+ baking cycles, depending on the conditions of use. Can be used for cooking and freezing (from -40°C to +240°C), for sweet and/or savory recipes. No need to grease, can be easily cleaned with water.

Il gruppo Sasa Demarle è l'unica azienda al mondo a formulare e produrre il proprio silicone alimentare, appositamente progettato per l'industria della panificazione e della pasticceria. L'uso di questo silicone consente una distribuzione ottimale del calore, offrendo una cottura e un colore uniformi, nonché proprietà antiaderenti perfette per una facile e perfetta sformatura. Gli stampi Flexipan offrono grandi prestazioni con un'elevata aspettativa di vita: da 3.000 a 5.000 e più cicli di cottura, a seconda delle condizioni di utilizzo. Può essere utilizzato per cucinare e congelare (da -40°C a +240°C), per ricette dolci e/o salate. Non serve ungere gli stampi e si pulisce facilmente con acqua.





Bavarois

Pcs/pz 18 - ml. 100

art.	Ø mm.	h.
47740105	78	35



Champagne biscuits

Pcs/pz 45 - ml. 20

art.	mm.
47740-29	109x24x10



Charlotte

Pcs/pz 24 - ml. 60

art.	Ø mm.	h.
47740-80	62	35



Charlotte

Pcs/pz 18 - ml. 100

art.	Ø mm.	h.
47740-23	78	40



Chocolate bars

Pcs/pz 18 - ml. 100

art.	mm.
47740128	78x58x40



Christmas log

Pcs/pz 8 - ml. 450

art.	mm.
47740-28	339x40x39



Christmas log

Pcs/pz 24 - ml. 80

art.	mm.
47740-26	95x40x30



Christmas log

Pcs/pz 24 - ml. 115

art.	mm.
47740-27	122x42x32



Christmas log insert

Pcs/pz 5 - ml. 700

art.	mm.
47740-93	495x40x39

With s/s frame. – Con supporto inox.



Cylinders

Pcs/pz 24 - ml. 65

art.	Ø mm.	h.
47740-52	63/55	25
47740-06	63/55	35



Cylinders

Pcs/pz 15 - ml. 220

art.	Ø mm.	h.
47740-69	82	50
47740-70	91	35



Cone insert

Pcs/pz 40 - ml. 24

art.	Ø mm.	h.
47740102	50	40



Cones

Pcs/pz 20 - ml. 80

art.	Ø mm.	h.
47740103	70	60



Cookies

Pcs/pz 40 - ml. 30

art.	Ø mm.	h.
47740-18	59/48	13
47740-60	78	10



Cookies

Pcs/pz 12 - ml. 245

art.	Ø mm.	h.
47740-74	100	35
47740-75	105	40



Eggs

Pcs/pz 25 - ml. 95

art.	mm.
47740135	94x60x31



Exagon

Pcs/pz 60 - ml. 12

art.	mm.
47740-83	45x40x12

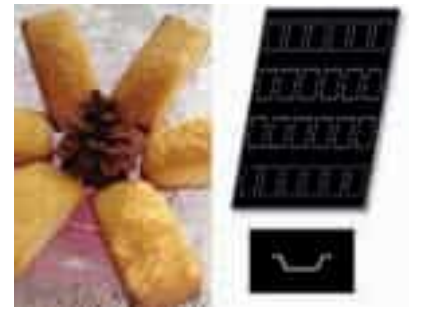

Financiers

Pcs/pz 24 - ml. 45

art.	mm.
47740-10	86x46x14



Flan bases

Pcs/pz 24 - ml. 70

art.	Ø mm.	h.
47740-43	80	20



Fluted brioches

Pcs/pz 24 - ml. 60

art.	mm.
47740-57	62x49x26



Fluted brioches

Pcs/pz 24 - ml. 60

art.	Ø mm.	h.
47740-58	68	25
47740-59	78	30
47740-16	81	37



Fluted cakes

Pcs/pz 16 - ml. 105

art.	mm.
47740-95	110x60x25



Fluted ingots

Pcs/pz 24 - ml. 90

art.	mm.
47740127	106x46x25



Fluted tartlets

Pcs/pz 24 - ml. 70

art.	mm.
47740132	78x78x20





Half cylinder

Pcs/pz 48 - ml. 20

art. mm.

47740125 85x17x15



Half sphere

Pcs/pz 48 - ml. 20

art. Ø mm. h.

47740-02 42 21



Half sphere

Pcs/pz 24 - ml. 125

art. Ø mm. h.

47740-38 80 40



Half sphere

Pcs/pz 28 - ml. 50

art. Ø mm. h.

47740-37 58 31



Half sphere

Pcs/pz 24 - ml. 105

art. Ø mm. h.

47740-03 70 40



Hearts

Pcs/pz 20 - ml. 81

art. mm.

47740-89 75x65x35



Hearts

Pcs/pz 20 - ml. 90

art. mm.

47740-41 66x62x35



Hexagons

Pcs/pz 20 - ml. 90

art. Ø mm. h.

47740130 80 25



Hollow ingot

Pcs/pz 24 - ml. 70

art. mm.

47740123 100x40x25

47740124 120x40x25



Ingot

Pcs/pz 24 - ml. 100

art. mm.

47740122 120x40x25



Ingot

Pcs/pz 18 - ml. 139

art. mm.

47740-94 102x58x30



Interlacing hearts

Pcs/pz 8 - ml. 200

art. mm.

47740101 120x113x35



Landscapes

Pcs/pz 27 - ml. 80

art.	Ø mm.	h.
47740144	75	24



Little cushion

Pcs/pz 24 - ml. 70

art.	mm.
47740-77	71x57x23

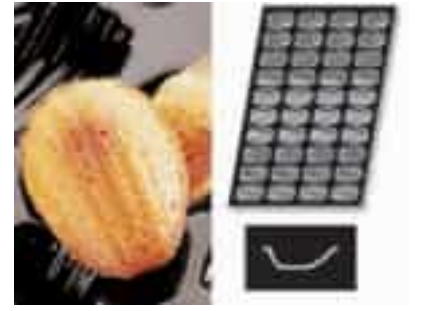

Madeines

Pcs/pz 40 - ml. 35

art.	mm.
47740-17	78x47x19



Medallions

Pcs/pz 54 - ml. 14

art.	Ø mm.	h.
47740-50	38	10



Medallions

Pcs/pz 96 - ml. 5

art.	Ø mm.	h.
47740-97	28	8



Mini Charlotte

Pcs/pz 60 - ml. 9

art.	Ø mm.	h.
47740-82	35	15



Mini chenilles

Pcs/pz 27 - ml. 90

art.	mm.
47740143	102x40x36



Mini drops

Pcs/pz 56 - ml. 18

art.	mm.
47740133	52x32x20



Mini écriins

Pcs/pz 24 - ml. 65

art.	mm.
47740142	50x50x29



Mini Madeines

Pcs/pz 56 - ml. 15

art.	mm.
47740106	52x33x15



Mini St Honoré crown

Pcs/pz 18 - ml. 70

art.	Ø mm.	h.
47740131	80	20



Muffins

Pcs/pz 24 - ml. 125

art.	Ø mm.	h.
47740-19	73	40
47740-68	79	36





Optagon

Pcs/pz 40 - ml. 28

art. mm.

47740-34 43x40x26



Oval savarins

Pcs/pz 12 - ml. 230

art. mm.

47740-81 100x80x45



Oval savarins

Pcs/pz 30 - ml. 48

art. mm.

47740111 70x50x22



Oval savarins

Pcs/pz 24 - ml. 70

art. mm.

47740-44 80x60x25



Oval tartlets

Pcs/pz 30 - ml. 35

art. mm.

47740-32 106x45x15



Ovals

Pcs/pz 24 - ml. 80

art. mm.

47740-49 96x45x28



Ovals

Pcs/pz 30 - ml. 55

art. mm.

47740-46 70x50x25

47740-47 70x50x30



Ovals

Pcs/pz 20 - ml. 100

art. mm.

47740-48 85x60x30



Ovals

Pcs/pz 48 - ml. 15

art. mm.

47740-92 70x30x10



Ovals

Pcs/pz 24 - ml. 80

art. mm.

47740-55 130x48x18



Pomponettes

Pcs/pz 96 - ml. 14

art. Ø mm. h.

47740-04 36 17



Puddings

Pcs/pz 15 - ml. 128

art. Ø mm. h.

47740104 65 55



Pyramids

Pcs/pz 24 - ml. 90

art. mm.

47740-13 71x71x41



Pyramids flat bottom

Pcs/pz 35 - ml. 50

art. mm.

47740-39 50x50x35



Quiches

Pcs/pz 15 - ml. 135

art. Ø mm. h.

47740-85 96 25



Quiches

Pcs/pz 24 - ml. 65

art. Ø mm. h.

47740-30 77 20



Quiches

Pcs/pz 42 - ml. 30

art. mm.

47740-45 60x40x25



Quiches

Pcs/pz 15 - ml. 140

art. Ø mm. h.

47740-62 102 20



Quiches

Pcs/pz 6 - ml. 200

art. Ø mm. h.

47740-64 147 12

47740-65 150 15

47740-66 166 12



Quiches

Pcs/pz 6 - ml. 360

art. Ø mm. h.

47740-71 140 25

47740-72 150 24

47740-05 186 12

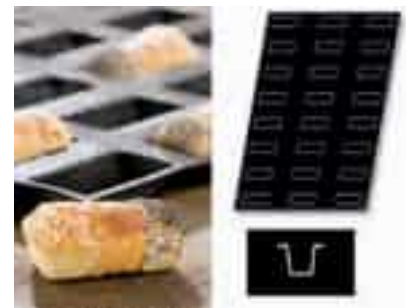

Rectangular cakes

Pcs/pz 24 - ml. 55

art. mm.

47740-25 80x30x30



Rectangular cakes

Pcs/pz 25 - ml. 110

art. mm.

47740-24 89x46x25



Rhombus

Pcs/pz 70 - ml. 9

art. mm.

47740-36 60x35x10



Round

Pcs/pz 11 - ml. 75

art. Ø mm. h.

47740-63 125 16



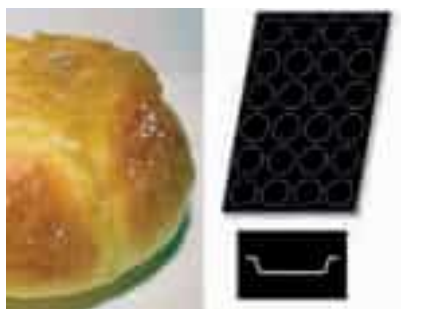

Round brioche
Pcs/pz 24 - ml. 65

art. Ø mm. h.
47740-56 79 15



Savarin zaphire
Pcs/pz 24 - ml. 80

art. mm.
47740114 70x70x32



Savarins
Pcs/pz 35 - ml. 50

art. Ø mm. h.
47740-20 66 20



Savarins
Pcs/pz 24 - ml. 65

art. Ø mm. h.
47740-15 70 23

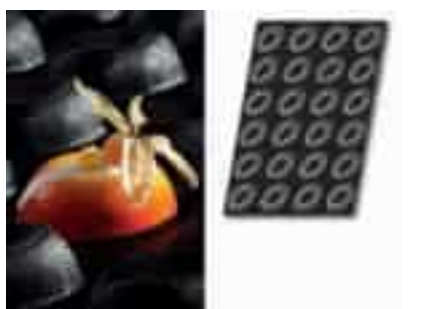

Scoop out
Pcs/pz 24 - ml. 90

art. mm.
47740145 85x61x30



Shells
Pcs/pz 24 - ml. 70

art. mm.
47740-79 80x75x20



Small cones
Pcs/pz 96 - ml. 6

art. Ø mm. h.
47740-99 30 20



Small cylinders
Pcs/pz 48 - ml. 25

art. Ø mm. h.
47740-51 40 20



Small financiers
Pcs/pz 84 - ml. 10

art. mm.
47740-09 50x26x11



Small fluted tartlet
Pcs/pz 40 - ml. 11

art. mm.
47740100 46x38x15



Small half sphere
Pcs/pz 96 - ml. 6

art. Ø mm. h.
47740-87 26 16



Small half sphere
Pcs/pz 70 - ml. 10

art. Ø mm. h.
47740-01 29 18



Small hearts

Pcs/pz 70 - ml. 15

art. mm.

47740115 41x38x16



Small muffins

Pcs/pz 40 - ml. 45

art. Ø mm. h.

47740-67 51 29



Small oval savarins

Pcs/pz 60 - ml. 9

art. mm.

47740-98 40x30x12



Small oval tartlets

Pcs/pz 48 - ml. 10

art. mm.

47740-31 66x27x11



Small ovals

Pcs/pz 50 - ml. 20

art. mm.

47740-11 51x31x20



Small ovals flat bottom

Pcs/pz 64 - ml. 18

art. mm.

47740-91 57x35x12

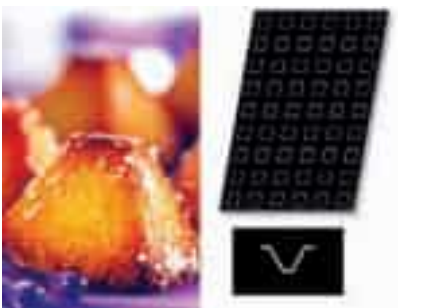

Small pyramids

Pcs/pz 54 - ml. 15

art. mm.

47740-12 35x35x23



Small quenelles

Pcs/pz 72 - ml. 56

art. mm.

47740-90 42x26x20



Small quiches

Pcs/pz 54 - ml. 22

art. Ø mm. h.

47740-33 40 20



Small quiches

Pcs/pz 60 - ml. 13

art. Ø mm. h.

47740-07 42 10



Small quiches

Pcs/pz 48 - ml. 20

art. Ø mm. h.

47740-08 48 15



Small quiches

Pcs/pz 40 - ml. 35

art. Ø mm. h.

47740-84 58 20





Small Savarins
Pcs/pz 60 - ml. 15
art. mm.
47740107 37x37x17



Small savarins
Pcs/pz 60 - ml. 10
art. Ø mm. h.
47740-14 41 12



Small squares
Pcs/pz 60 - ml. 18
art. mm.
47740116 37x37x17



Small squares
Pcs/pz 60 - ml. 20
art. mm.
47740109 45x45x12



Small upside-down half sphere
Pcs/pz 45 - ml. 6
art. Ø mm. h.
47740-86 26 16



Square Savarins
Pcs/pz 35 - ml. 45
art. mm.
47740108 56x56x24



Square Savarins
Pcs/pz 24 - ml. 100
art. mm.
47740-96 70x70x30



Squares
Pcs/pz 35 - ml. 60
art. mm.
47740117 56x56x24



Squares
Pcs/pz 40 - ml. 40
art. mm.
47740110 60x60x20



Stars
Pcs/pz 24 - ml. 35
art. mm.
47740-88 80x65x15

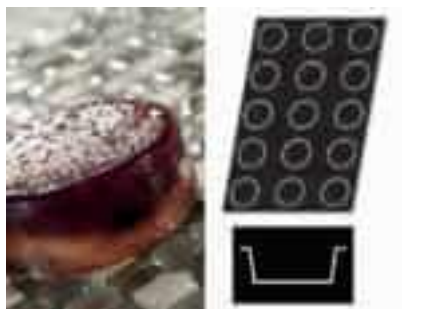

Tarte tatin
Pcs/pz 15 - ml. 135
art. Ø mm. h.
47740-73 82 30



Teddy bear
Pcs/pz 18 - ml. 80
art. mm.
47740-53 90x55x20



Triangles

Pcs/pz 80 - ml. 7

art. mm.

47740-35 48x41x10



Various petits-fours

Pcs/pz 60

art. h. mm.

47740134 22



Zaphire

Pcs/pz 54 - ml. 17

art. mm.

47740112 40x40x24



Zaphire

Pcs/pz 24 - ml. 75

art. mm.

47740113 70x70x35



Calisson

Pcs/pz 20 - ml. 118

art. mm.

47743-03 180x90x50



Lemon

Pcs/pz 20 - ml. 73

art. mm.

47743-05 85x65x34



Donuts

Pcs/pz 8

art. Ø mm. h.

47743-13 88 30



Triangles

Pcs/pz 24 - ml. 80

art. mm.

47743-10 70x95x25



Small half sphere

Mm 400x300

Pcs/pz 5 - ml. 63

art. Ø mm. h.

47741-76 23 11



Small hearts

Mm 400x300

Pcs/pz 30 - ml. 15

art. mm.

47741-78 52x49x10



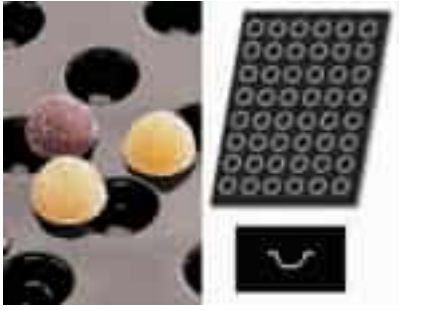

Half sphere flat
Mm 400x300
Pcs/pz 48 - ml. 10

art.	Ø mm.	h.
47741-77	30	13



Twisted bars
Mm 400x300
Pcs/pz 12

art.	mm.
47741-07	100x45x25



Stripped rectangle
Mm 280x160
Pc/pz 1

art.	mm.
47741-11	240x120x50



Stripped bars
Mm 400x300
Pcs/pz 16

art.	mm.
47741-13	100x30x15



Candy
Mm 400x300
Pcs/pz 12

art.	mm.
47741-15	65x50x36



Fluted crowns
Mm 400x300
Pcs/pz 8

art.	Ø mm.	h.
47741-20	80	26



FLEXIPAN® INSPIRATION

f FLEXIPAN®

PASTRY
PASTICCERIA



The FLEXIPAN® INSPIRATION range is the high-performance solution for both straight-edged and complex shapes. A new source of INSPIRATION for creations of both traditional shapes and special designs. Product advantages: 100% silicone, baking at +240 °C and freezing at -40 °C, designed for automated pan release, ideal for semi-industrial and industrial production, superior pan durability, easy pan release, precise, detailed shapes.

La gamma FLEXIPAN® INSPIRATION è la soluzione ad alte prestazioni per prodotti con bordi dritti e per le forme complesse. Una nuova fonte di ISPIRAZIONE per le creazioni sia con forme tradizionali o di design speciali. Vantaggi del prodotto: 100% silicone, cottura a +240°C e congelamento a -40°C, progettati per il rilascio automatico dello stampo, ideale per la produzione semi industriale e industriale, durata superiore dello stampo, facile sformatura, forme precise e dettagliate.



Twist
Mm 400x300
Pcs/pz 48

art.	Ø mm.	h.
47741-00	32	20



Stars
Mm 400x300
Pcs/pz 48

art.	Ø mm.	h.
47741-01	32	13



Insert fingers
Mm 400x300
Pcs/pz 18

art.	mm.
47741-02	120x11



Sphere 3D
Mm 400x300
Pcs/pz 8

art.	Ø mm.	h.
47741-05	65	50



Waffels
Mm 400x300
Pcs/pz 8 - ml. 100

art.	mm.
47741-38	80x127x15



Fingers
Mm 400x300
Pcs/pz 24 - ml. 54

art.	mm.
47741-37	129x28x15



Cylinder
Mm 600x400
Pcs/pz 24 - ml. 148

art.	Ø mm.	h.
47744-30	70	40



Cube
Mm 600x400
Pcs/pz 96 - ml. 17

art.	mm.
47744-32	30x30x20



Kougloff
Mm 600x400
Pcs/pz 24 - ml. 150

art.	Ø mm.	h.
47744-31	80	54



Diamond
Mm 600x400
Pcs/pz 24 - ml. 100

art.	Ø mm.	h.
47744-34	79	40



Insert ring
Mm 600x400
Pcs/pz 24

art.	Ø mm.	h.
47743-15	61	9



Ring 3D
Mm 600x400
Pcs/pz 24

art.	Ø mm.	h.
47743-16	76	25



NEW

Flower buds
Mm 400x300
Pcs/pz 30

art.	mm.
47744-04	45x45x21



NEW

Fluted rectangles
Mm 400x300
Pcs/pz 12

art.	mm.
47744-05	65x54x22



NEW

Saint-Honoré
Mm 400x300
Pcs/pz 9

art.	Ø mm.	h.
47744-06	81	30



NEW

Cathedrals
Mm 400x300
Pcs/pz 14

art.	mm.
47744-07	103x34x48



Half sphere

art.	Ø mm.	h.	ml.
47744-81	180	90	1600



NEW

Rond

art.	Ø mm.	h.
47744-02	220	45



Flexiform desserts

art.	mm.	ml.
47744-58	253x253x45	222



Flexiform desserts

art.	mm.	ml.
47744-59	600x400x50	980



Silpat entremet

art.	mm.
47744-48	280x480x13
47744-60	360x555x10
47744-62	360x555x20

3D DESIGNS FOR DESSERTS - DISCS & MATS



3D disc Rosace

art.	Ø mm.	h. mm.
47744-10	225	6



NEW

3D disc Dots

art.	Ø mm.	h. mm.
47744-01	216	8



NEW

3D disc Flower crown

art.	Ø mm.	h. mm.
47744-03	216	2



3D mat Venetian Cane

art.	mm.
47744-19	555x360

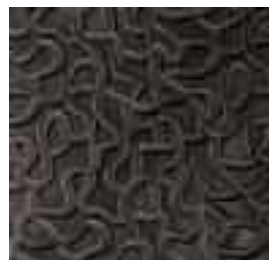

3D mat Labyrinth

art.	mm.
47744-21	600x400



3D mat Bubbles

art.	mm.
47744-36	600x400





3D mat Mikado

art. mm.
47744-37 600x400



3D mat Buche2

art. mm.
47744-70 275x185



3D mat Buche1

art. mm.
47744-71 275x185



SILPAT® – SILPAIN® – ROUL'PAT®

SILPAT: Non-stick sheet ideal for backing brioches and buns as well as any kind of sweet bread backed in sheets. **Ideal also for working sugar. SILPAIN:** Non-stick perforated sheet ideal for baking bread and tarts. **ROUL'PAT:** The silicone coating on both sides prevents the sheet from slipping. Perfect to prepare any type of dough and it also enables to easily prepare macaroon.

SILPAT: Antiaderente ideale per la cottura di tutte le viennoiseries e tutti i tipi di pasticceria da panetteria cotti in teglie. Ideale anche per la lavorazione dello zucchero. SILPAIN: Antiaderente areato ideale per la cottura di pani e la cottura in bianco di fondi per crostate. ROUL'PAT: Con il rivestimento in silicone su entrambi i lati, non scivola sul piano di lavoro. Permette di lavorare ogni tipo di pasta, e con grande facilità anche il croccante.



SILPAT Silicone baking sheet

Tappeto silicone
Silikonbackmatte
Tapis cuisson en silicone
Tapete de cocción silicona
art. GN mm.
47680-40 - 400x300
47680-53 1/1 530x325
47680-60 - 600x400



SILPAIN Silicone baking sheet

Tappeto silicone
Silikonbackmatte
Tapis de cuisson en silicone
Tapete de cocción silicona
art. GN mm.
47685-53 1/1 530x325
47685-60 - 600x400



ROUL'PAT Silicone baking sheet

Tappeto silicone
Silikonbackmatte
Tapis de cuisson en silicone
Tapete de cocción silicona
art. mm.
47688-60 600x400

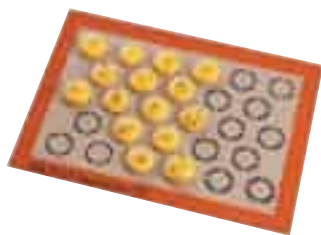

NEW

SILPAT Macarons

Tappeto silicone
Silikonbackmatte
Tapis de cuisson en silicone
Tapete de cocción silicona

art.	Ø mm.	No.	mm.
47683-01	35	28	400x300
47683-02	35	63	600x400
47683-03	50	28	600x400



NEW

SILPAIN Éclair

Tappeto silicone
Silikonbackmatte
Tapis de cuisson en silicone
Tapete de cocción silicona

art.	No.	mm.
47685-61	18	600x400

FLEXIPAN® AIR



Flexible pans made of silicone and glass fiber fabric and bi-component, designed for bread-making and bakery products, especially for cream puffs dough. The pre-formed shapes make easy obtaining perfect, regular and same size products. Neither greasing the sheet nor spiking the dough is required before baking. The non-stick property of the material allows an easy and perfect extraction. They have a well-ventilated texture that ensures proper heat circulation, to obtain a crusty finished product with excellent color. Non-stick FLEXIPAN® AIR sheets are very durable, lasting up to 1500 cycles without any risk of sticking. For baking up to +240°, as well as for freezing at -40°, and are also designed to hold frozen dough. Using FLEXIPAN® AIR pans the products will be well calibrated and perfectly homogenous in terms of size, color and crust.

Stampi flessibili realizzati in silicone e tessuto in fibra di vetro e bicomponente, ideali per la panificazione e prodotti dolci da forno, in particolare per la pasta di bigné. Grazie alle impronte preformate, preparare prodotti uguali e regolari diventa facile. Non è più indispensabile spennellare con tuorlo o forare la pasta. Grazie alle sue proprietà antiaderenti l'estrazione è impeccabile. Hanno una texture ben ventilata che garantisce una corretta circolazione del calore, per ottenere un prodotto finito croccante e dal colore eccellente. Gli stampi FLEXIPAN® AIR sono molto resistenti, durano fino a 1500 cicli senza alcun rischio che il prodotto si attacchi. Per cotture fino a +240°, come pure per congelare a -40°, e sono progettati anche per contenere impasti surgelati. L'utilizzo di FLEXIPAN® AIR consente di ottenere prodotti ben calibrati e perfettamente omogenei per dimensione, colore e crosta.



Paris-Brest

Mm 600x400
Pcs/pz 24 - ml. 50

art.	Ø mm.	h.
41760-27	80	15



Oval choux

Mm 600x400
Pcs/pz 25 - ml. 56

art.	mm.
41760-26	90x60x15



Baby choux

Mm 600x400
Pcs/pz 59 - ml. 4

art.	Ø mm.	h.
41760-22	30	5



Big choux

Mm 600x400

Pcs/pz 28 - ml. 48

art.	Ø mm.	h.
41759-01	67	15

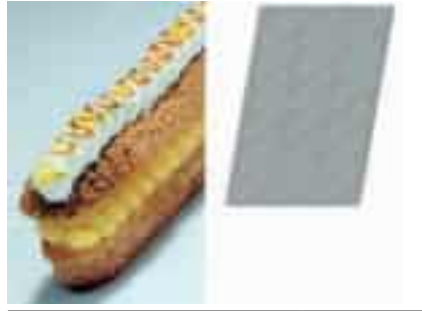

Eclairs - Right handed / Per ambidestri

Mm 600x400

Pcs/pz 18 - ml. 15

art.	mm.
41760-20	125x25x5



Eclairs - Left handed / Per mancini

Mm 600x400

Pcs/pz 18 - ml. 15

art.	mm.
41760-21	125x25x5



Round shapes / Forme rotonde

Mm 600x400

Pcs/pz 28 - ml. 48

art.	Ø mm.	h.
41759-01	67	15



Round shapes / Forme rotonde

Mm 600x400

Pcs/pz 15 - ml. 140

art.	Ø mm.	h.
41759-05	102	20



Round shapes / Forme rotonde

Mm 600x400

Pcs/pz 11 - ml. 175

art.	Ø mm.	h.
41759-09	125	16





Oval shapes / Forme ovali

Mm 600x400

Pcs/pz 24 - ml. 80

art.	mm.	h.
41760-02	95x40	30



Oval shapes / Forme ovali

Mm 600x400

Pcs/pz 18 - ml. 50

art.	mm.	h.
41760-05	155x41	25



Oval shapes / Forme ovali

Mm 600x400

Pcs/pz 12 - ml. 230

art.	mm.	h.
41760-06	169x64	30



Oval shapes / Forme ovali

Mm 600x400

Pcs/pz 8 - ml. 400

art.	mm.	h.
41760-08	259x64	30



Oval shapes / Forme ovali

Mm 600x400

Pcs/pz 6 - ml. 435

art.	mm.	h.
41760-09	314x60	30



Square shapes / Forme quadrate

Mm 600x400

Pcs/pz 15 - ml. 200

art.	mm.
41759-04	93x93x28

NEW



Sandwich

Mm 600x400

Pcs/pz 8 - ml. 500

art.	mm.
41759-07	240x70x35

NEW



Brioches

Mm 390x250

Pcs/pz 2

art.	mm.
41759-08	211x158x32

NEW



French loaves perforated sheet, silicone coated

Teglia alluminio forato, siliconata

Pariserbrotblech, Silikon-beschichtet

Plaque perforée pain parisien, siliconée

Placa pan perforada, siliconada

art.	cm.	pcs/pz
41758-53	53x32	4
41758-60	60x40	5
41758-65	65x43	6
41758-85	85x43	6



ABS

Bread mould

Stampo per pane
Brot-Ausstechforme
Découpoir à pain
Cortador para pan

art.	cm.
47041-01	14x10



ABS

Bread mould

Stampo per pane
Brot-Ausstechforme
Découpoir à pain
Cortador para pan

art.	cm.
47041-02	14x11



ABS

Bread mould

Stampo per pane
Brot-Ausstechforme
Découpoir à pain
Cortador para pan

art.	Ø cm.
47041-05	12,5



ABS

Bread mould
Stampo per pane
Brot-Aussteckforme
Découpoir à pain
Cortador para pan

art.	Ø cm.
47041-07	8



Bread brush
Spazzola pane
Brot-Bürste
Brosse à pain
Cepillo para pan

art.	l. cm.
42614-04	24,5
42614-05	32,0
42614-06	41,0
42614-07	46,0



SS

Disposable baker's blades
Lame panettiere usa e getta
Einweg-Bäcker-Klingen
Incisette boulanger jetables
Láminas del panadero desechables

art.	l. cm.	pcs/pz
48290-10	12	10



PE

Bread basket
Cesta pane
Brot-Korb
Corbeille à pain
Cesta pan

art.	cm.	lt.
44982-04	57x36x34	40
44982-06	66x45x35	60
44982-10	78x52x40	100

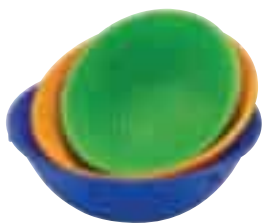

PP

Bread proofing basket
Cestino impasto
Gärkorb
Banneton
Molde para pan

art.	Ø cm.	h.	gr.	col.
47042-19	19	7,5	500	●
47042-22	22	9,3	1000	●
47042-25	25	9	1500	●



PP

Bread proofing basket
Cestino impasto
Gärkorb
Banneton
Molde para pan

art.	cm.	gr.	col.
47043-27	27x12x6,5	500	●
47043-35	35x13x7,2	1000	●
47043-42	42x14x7,5	1500	●



ETHNIC CUISINE CUCINA ETNICA

ASIA FUSION



The images of the products in this chapter reflect the characteristics of the products in the warehouse. However, they have to be considered mainly for illustrative purposes only. Although we make every effort to display the products accurately, the products received may vary slightly from those images. In any case the changes are intended as improvements and do not alter the function, nor lessen the utility of the product.

Tutte le foto degli articoli presenti nel capitolo rispecchiano il più possibile le caratteristiche dei prodotti presenti in magazzino. Teniamo comunque a precisare che le immagini sono indicative ed i prodotti reali potrebbero differire nei colori e nelle dimensioni. Le variazioni sono in ogni caso migliorative e tali da non alterare la natura e la funzionalità del prodotto stesso.



The THARA series presents tableware inspired by oriental cuisine, Chinese, Japanese and Thai. Not just a fashion but a lifestyle that conquers for its taste and style. The appearance is that of stoneware. Withstands temperatures from -20°C to +70°C.

La serie THARA presenta articoli da tavola ispirati alla cucina orientale, cinese, giapponese e thailandese. Non solo una moda ma uno stile di vita che conquista per il suo gusto e per il suo stile. L'aspetto è quello del gres. Termoresistente da -20°C a +70°C.



Rice bowl

Coppa riso
Reistasse
Bol à riz
Cuenco arroz

art.	Ø cm.	h.	lit.	col.
44463-11	11	7	0,3	●



Tray

Vassoio
Platte
Plateau
Bandeja

art.	dim. cm.	col.
44464-23	23,5x7,5x2	●



Tray

Vassoio
Platte
Plateau
Bandeja

art.	dim. cm.	col.
44465-24	24,5x6,5x1,5	●



Bowl
Ciotola
Schüssel
Bol
Cuenco Ensalada

art.	Ø cm.	h.	col.
44452-31	31	8,5	○
44452B31	31	8,5	●



Bowl
Ciotola
Schüssel
Bol
Cuenco Ensalada

art.	dim. cm.	col.
44453-14	14,5x12x5,5	○
44453B14	14,5x12x5,5	●



Bowl
Ciotola
Schüssel
Bol
Cuenco Ensalada

art.	Ø cm.	h.	col.
44454-11	11,5	4	○
44454B11	11,5	4	●



Bowl
Ciotola
Schüssel
Bol
Cuenco Ensalada

art.	dim. cm.	col.
44455-09	9x7x2,5	○
44455B09	9x7x2,5	●



Bowl
Ciotola
Schüssel
Bol
Cuenco Ensalada

art.	dim. cm.	col.
44456-14	14x9x2,5	○
44456B14	14x9x2,5	●



Bowl
Ciotola
Schüssel
Bol
Cuenco Ensalada

art.	dim. cm.	col.
44457-32	32,5x14x4	○
44457B32	32,5x14x4	●



Tray
Vassoio
Platte
Plateau
Bandeja

art.	dim. cm.	col.
44461-20	18,5x18,5x4,5	○
44461B20	18,5x18,5x4,5	●



Bowl
Ciotola
Schüssel
Bol
Cuenco Ensalada

art.	dim. cm.	col.
44450-21	21x21x11	○
44450B21	21x21x11	●



Bowl
Ciotola
Schüssel
Bol
Cuenco Ensalada

art.	dim. cm.	col.
44450-12	12x12x4	○
44450B12	12x12x4	●



Bowl
Ciotola
Schüssel
Bol
Cuenco Ensalada

art.	dim. cm.	col.
44450-17	17,5x17,5x7	○
44450B17	17,5x17,5x7	●



Tray
Vassoio
Platte
Plateau
Bandeja

art.	dim. cm.	col.
44451-22	22x12x3	○
44451B22	22x12x3	●



Tray
Vassoio
Platte
Plateau
Bandeja

art.	dim. cm.	col.
44462-25	25x25x5,5	○
44462B25	25x25x5,5	●



Dish
Piatto
Teller
Assiette
Plato

art.	Ø cm.	h.	col.
44459-28	28	3	○
44459B28	28	3	●



Bowl
Ciotola
Schüssel
Bol
Cuenco Ensalada

art.	dim. cm.	h.	col.
44450-11	11x10	3	○
44450B11	11x10	3	●



Bowl
Ciotola
Schüssel
Bol
Cuenco Ensalada

art.	dim. cm.	h.	col.
44450-13	13x11	3,5	○
44450B13	13x11	3,5	●



Bowl
Ciotola
Schüssel
Bol
Cuenco Ensalada

art.	dim. cm.	col.
44450-15	17,5x15,5x5,5	○
44450B15	17,5x15,5x5,5	●



Tray
Vassoio
Platte
Plateau
Bandeja

art.	dim. cm.	col.
44450-23	22x23,5x5,5	○
44450B23	22x23,5x5,5	●



Soup/riso bowl with lid
Ciotola riso con coperchio
Reisschüssel mit Deckel
Bol à riz avec couvercle
Cuenco arroz con tapa

art.	Ø cm.	h.
49655-34	10	6,5

MF





Levantine cuisine served appropriately. Lots of vegetables, little meat and a variety of spices characterize the cuisine of the Middle East. The eastern Mediterranean region, i. e. Syria, Lebanon, Jordan, Israel and Palestine are referred to as the Levant. The food tradition of these countries are celebrated as a food trend.

Cucina levantina servita in modo appropriato. Tanta verdura, poca carne e una varietà di spezie caratterizzano la cucina del Medio Oriente. Le regioni del Mediterraneo orientale, come Siria, Libano, Giordania, Israele e Palestina sono indicati come Levante. Le tradizioni alimentari di questi paesi vengono celebrate come tendenza.



Bowl
Ciotola
Schale
Bol
Cuenco

art.	Ø cm.	h.
49656C10	9,5	4,2
49656C12	12,0	6,2
49656C17	17,0	9,0

Double wall. – Doppia parete.



Bowl
Ciotola
Schale
Bol
Cuenco

art.	Ø cm.	h.
49656B10	9,5	4,2
49656B12	12,0	6,2
49656B17	17,0	9,0

Double wall. – Doppia parete.



Bowl
Ciotola
Schale
Bol
Cuenco

art.	Ø cm.	h.
49656C07	7,5	2,5



Bowl
Ciotola
Schale
Bol
Cuenco

art.	Ø cm.	h.
49656B07	7,5	2,5



Bowl
Ciotola
Schale
Bol
Cuenco

art.	Ø cm.	h.
49656C08	8,5	5,5
49656C09	8,5	8,5



Bowl
Ciotola
Schale
Bol
Cuenco

art.	Ø cm.	h.
49656B08	8,5	5,5
49656B09	8,5	8,5



NEW

Set 6 dip bowls

Set 6 ciotoline
Satz 6 Dipschälchen
Set 6 bols
Juego 6 cuencos

art.	Ø cm.	h.	ml.
49656C04	6	2,5	40
49656C06	6	4,5	60



NEW

Set 6 dip bowls

Set 6 ciotoline
Satz 6 Dipschälchen
Set 6 bols
Juego 6 cuencos

art.	Ø cm.	h.	ml.
49656B04	6	2,5	40
49656B06	6	4,5	60



Tray

Vassoio
Tablett
Plateau
Bandeja

art.	dim. cm.
49656C26	25,5x16x3



Tray

Vassoio
Tablett
Plateau
Bandeja

art.	dim. cm.
49656B26	25,5x16x3



W

Tortillas cup

Contenitore per tortillas
Tortilla-Behälter
Conteneur à tortillas
Recipiente para tortillas

art.	Ø cm.
44241-19	19



ABS

MF



Bento box with lid 7 pcs

Scatola bento con coperchio 7 pz
Bento-Box mit Deckel 7-tlg
Boîte à bento avec couvercle 7 pcs
Caja bento con tapa 7 pz

art.	dim. cm.
44357B07	30x25x8



SS

Taco holder, 2 pcs

Supporto per tacos, 2 pz
Taco-Ständer, 2 Stk
Support à tacos, 2 pcs
Soporte para tacos, 2 pz

art.	dim. cm.
49657-03	23x10x5



MF

Chinese spoon

Cucchiaio cinese
Chinesischer Löffel
Cuillère chinoise
Cuchara china

art.	dim. cm.	col.
44850-13	13,5x4,5	○
44850B13	13,5x4,5	●



W

Sushi bridge

Ponte per sushi
Sushi-Brücke
Pont à sushi
Puente para sushi

art.	dim. cm.
49655-41	38X18X12,5
49655-39	52x26x15





W

Sushi dragon boat

Barca per sushi dragone
Sushi-Drachenboot
Bateau à sushi dragon
Barco do dragão para sushi

art. dim. cm.
49657-09 40x10x16



W

Sushi boat

Barca per sushi
Sushi-Boot
Bateau à sushi
Barco para sushi

art. dim. cm.
49655-29 50x20x13



W

Hand roll stand

Supporto per temaki
Temaki-Ständer
Support pour temaki
Soporte para temaki

art. dim. cm.
49655-31 18x9x8,5



W

Sushi geta board

Tagliere sushi
Sushi-Servierbrett
Planche à sushi
Tabla para sushi

art. dim. cm.
49655-24 24x15x3
49655-67 27x18x3



W

Sushi ladder 5 steps

Espositore sushi 5 piani
Sushi-Display 5 Etagen
Présentoir à sushi 5 étages
Expositor de sushi 5 pisos

art. dim. cm.
49655-68 32,5x25x10



W

Sushi ladder 7 steps

Espositore sushi 7 piani
Sushi-Display 7 Etagen
Présentoir à sushi 7 étages
Expositor de sushi 7 pisos

art. dim. cm.
49655-69 38x26x15



W

Sushi ladder 6 steps

Espositore sushi 6 piani
Sushi-Display 6 Etagen
Présentoir à sushi 6 étages
Expositor de sushi 6 pisos

art. Ø cm. h.
49655-73 28 12



W

Sushi box

Contenitore sushi
Sushi-Box
Boîte à sushi
Caja sushi

art. dim. cm.
49657-12 32x21,5x4,5

With eutectic plate to be filled with water.
Con placca eutettica da riempire con acqua.



W

Sushi box

Contentitore sushi
Sushi-Box
Boîte à sushi
Caja sushi

art. dim. cm.
49657-10 24x24x4,5



B

Sushi small boat

Barchetta sushi
Kleines Sushi-Boot
Petit bateau à sushi
Barco sushi pequeño

art. dim. cm.
49657-30 29x10x5



W

Sushi box

Contentitore sushi
Sushi-Box
Boîte à sushi
Caja sushi

art. dim. cm.
49657-11 20x30x4,5



B

Sushi container

Piatto presentazione sushi
Sushi-Behälter
Conteneur à sushi
Contenedor sushi

art. dim. cm.
49657-32 26x12x5



B

Sushi container

Piatto presentazione sushi
Sushi-Behälter
Conteneur à sushi
Contenedor sushi

art. dim. cm.
49657-33 32x12x10



B

Sushi container

Piatto presentazione sushi
Sushi-Behälter
Conteneur à sushi
Contenedor sushi

art. Ø cm. h.
49657-37 16 11+19





B

Sushi shell

Conchiglia sushi
Sushi-Schale
Coquille à sushi
Concha sushi

art. l. cm.
49657-31 20-24



B

Sushi container

Piatto presentazione sushi
Sushi-Behälter
Conteneur à sushi
Contenedor sushi

art. dim. cm.
49657-34 34x14x13



B

Sushi container

Piatto presentazione sushi
Sushi-Behälter
Conteneur à sushi
Contenedor sushi

art. dim. cm. h.
49657-35 22x15 5+10



B

Sushi container

Piatto presentazione sushi
Sushi-Behälter
Conteneur à sushi
Contenedor sushi

art. Ø cm. h.
49657-36 16 10+17



Teapot

Teiera
Teekanne
Théière
Tetera

art. dim. cm. h. lt.
49655R70 19,5x18 15 0,8



Teapot

Teiera
Teekanne
Théière
Tetera

art. dim. cm. h. lt.
49655-70 19,5x18 15 0,8



Teapot warmer

Rechaud
Stövchen
Chauffe-théière
Calentador

art. Ø cm. h.
49655-72 13 7,5

Cast iron with s/steel strainer. For 2-3 cups.
In ghisa con colino inox. Per 2-3 tazze.

Cast iron with s/steel strainer. For 2-3 cups.
In ghisa con colino inox. Per 2-3 tazze.



Teapot

Teiera
Teekanne
Théière
Tetera

art.	dim. cm.	h.	lt.
49655-80	12,5x11	12,5	0,3

Cast iron, without tea strainer.
In ghisa, senza colino.



Teapot

Teiera
Teekanne
Théière
Tetera

art.	dim. cm.	h.	lt.
49655B91	17x14	17	0,8

Cast iron, inside enamelled. S/steel strainer.
In ghisa, interno smaltato. Colino inox.



Teapot

Teiera
Teekanne
Théière
Tetera

art.	dim. cm.	h.	lt.
49655G91	17x14	17	0,8

Cast iron, inside enamelled. S/steel strainer.
In ghisa, interno smaltato. Colino inox.



Coaster

Sottoteiera
Untersetzer
Repose théière
Reposa tetera

art.	Ø cm.	h.
49655-81	13,5	1,5

Cast iron with non-slip feet.
In ghisa con piedini antiscivolo.



Tray

Vassoio
Tablett
Plateau
Bandeja

art.	GN	dim. cm.
49655-86	1/2	32,5x26,5x3



Chopsticks

Bacchette cinesi
Ess-Stäbchen
Baguettes
Palillos

art.	l. cm.	pairs/paia
49658-01	27	10



Chopsticks

Bacchette cinesi
Ess-Stäbchen
Baguettes
Palillos

art.	l. cm.	pairs/paia
49658-02	27	10

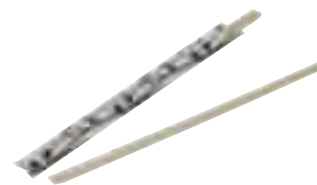

Disposable chopsticks

Bacchette monouso
Einweg Ess-Stäbchen
Baguettes jetables
Palillos desechables

art.	l. cm.	pairs/paia
48300-29	21	50

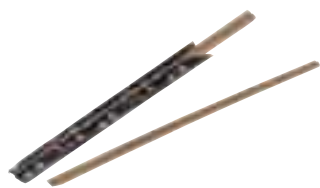

B

Disposable chopsticks

Bacchette monouso
Einweg Ess-Stäbchen
Baguettes jetables
Palillos desechables

art.	l. cm.	pairs/paia
49627-22	24	100



MF

Chopstick rest

Supporto bacchette cinesi
Ess-Stäbchen Ablage
Pose baguettes
Soporte para palillos

art.	dim. cm.	col.
49655-27	5x3,5x1,8	●



B

Noshikushi skewers

Spiedini noshikushi
Noshikushi Spieße
Brochettes noshikushi
Pinchos noshikushi

art.	l. cm.	pcs/pz
48300-42	10,5	100



B

Tepokushi skewers

Spiedini tepokushi
Tepokushi Spieße
Brochettes tepokushi
Pinchos tepokushi

art.	l. cm.	pcs/pz
48300-43	9	100
48300-33	15	100



B

Sushi mat

Stuoietta
Sushi-Matte
Natte à rouler les sushis
Mantelín para sushi

art.	dim. cm.
49626-00	24x24



B

Sushi mat

Stuoietta
Sushi-Matte
Natte à rouler les sushis
Mantelín para sushi

art.	dim. cm.
49626-02	27x27



W

Sushi mould

Stampo sushi
Sushi-Form
Moule à sushi
Molde para sushi

art.	dim. cm.
49655-02	21x7,5x4,5



B

Rice paddle

Cucchiaio riso
Reislöffel
Cuillère à riz
Cuchara arroz

art.	l. cm.
49655-89	20



B

Rice knife

Coltello riso
Reismesser
Couteau à riz
Cuchillo arroz

art.	l. cm.
49655-90	17,5



W

Hangiri/sushi rice tub

Vasca riso hangiri
Hangiri/Sushi-Reis-Wanne
Bol à riz sushi/hangiri
Cuenco arroz sushi/hangiri

art.	Ø cm.
49655-50	36
49655-49	45



B

Steamer

Cuocivapore
Dampfgarer
Panier vapeur
Vaporera

art.	Ø cm.
49603-15	16
49603-20	20
49603-25	25
49603-30	30
49603-40	40
49603-50	50

2 bodies + 1 cover. – 2 ceste + 1 coperchio.



Steamer net liner, 6 pcs

Stuoietta cuocivapore, 6 pz
Matte zum Dämpfen, 6 Stk
Natte pour cuisson à la vapeur, 6 pcs
Mantelín para cocinar al vapor, 6 pz

art.	Ø cm.
49614-15	15
49614-20	19
49614-25	24
49614-30	29
49614-40	39
49614-50	49



Wok with grid and cover, 3-ply

Wok c/griglia e coperchio, 3-ply
Wok mit Rost und Deckel, 3-ply
Wok avec grille et couvercle, 3-ply
Wok con rejilla y tapa, 3-ply

art.	Ø cm.	h.
12529-32	32	8



Steel wok pan

Wok, ferro
Wok-Eisenpfanne
Poêle chinoise, acier
Wok, hierro

art.	Ø cm.	h.
11713-32	32	10
11713-40	40	11



Steel wok pan

Wok, ferro
Wok-Eisenpfanne
Poêle chinoise, acier
Wok, hierro

art.	Ø cm.	h.
49604-31	30,5	9
49604-36	35,5	11
49604-41	40,5	12



Steel wok pan

Wok, ferro
Wok-Eisenpfanne
Poêle chinoise, acier
Wok, hierro

art.	Ø cm.	h.
49605-46	45,5	14,0
49605-61	61,0	18,5
49605-71	71,0	22,0



SS

Wok stand

Base per wok
Fuss für Wokpfanne
Base pour wok
Base para Wok

art.	Ø cm.
11953-22	22



Steel fry pan

Padella per friggere, ferro
Frittier-Eisenpfanne
Tuile à frire, acier
Sartén freidora, hierro

art.	Ø cm.	h.	lt.
41707-32	32	9,8	6,0
41707-36	36	11,0	8,8
41707-40	40	13,4	12,2
41707-45	45	15,0	17,3
41707-50	50	17,6	23,5



Wire basket, tinned

Cestello per friggere, stagnato
Frittier-Rost, verzinkt
Grille à frire, étamée
Cesta escurrefrito, estañada

art.	Ø cm.	h.
41708-32	29,5	8,7
41708-36	32,6	9,3
41708-40	39,0	12,4
41708-45	43,0	15,0
41708-50	46,5	17,0



SS

Steamer

Cuocivapore
Dampf-Kocher
Cuisneur à vapeur
Cuscusera

art.	Ø cm.	h.
49606-51	51	14
49606-00	51	14
49606-01	51	20



Mortar and pestle

Mortaio e pestello
Mörser und Stößel
Mortier et pilon
Mortero y pistilo

art.	Ø cm.	h.	Kg.
49618-12	12,5	9,0	1,9
49618-15	15,0	10,0	3,2
49618-18	17,0	11,5	3,9



SS

Wasabi grater

Grattugia per wasabi
Wasabi-Raffel
Rape à wasabi
Rallador para wasabi

art.	dim. cm.
42555-11	11x7,5

Dishwasher safe. To mash garlic, wasabi, ginger, horseradish. To grind almonds, nutmeg.
Lavabile in lavastoviglie. Per grattugiare aglio, wasabi, zenzero, rafano, mandorle, noce moscata.



SS

Oil pourer

Oliera
Ölkanne
Huilière
Alcuza

art.	ml.
41780-05	500
41780-07	750
41780-09	1000



Chinese kitchen scissors

Forbici cucina cinesi
Chinesische Küchenschere
Ciseaux de cuisine chinois
Tijeras de cocina china

art.	dim. cm.
49636-00	17x8,5

Stainless steel and brass. – Inox e ottone.



Fry basket, coarse mesh

Schiumarola fritto, rete grossa
Frittierkorb
Panier de friture
Cesta para freír

art.	Ø cm.
49607-15	15,0
49607-20	20,0
49607-25	25,5
49607-30	30,5

Bamboo handle, stainless steel mesh.
Manico bamboo, rete inox.



Fry basket, fine mesh

Schiumarola fritto, rete fine
Frittierkorb
Panier de friture
Cesta para freír

art.	Ø cm.
49608-15	15,0
49608-20	20,0
49608-25	25,5
49608-30	30,5
49608-35	35,5

Bamboo handle, stainless steel mesh.
Manico bamboo, rete inox.



Ladle

Mestolo
Schöpflöffel
Louche
Cacillo

art.	Ø cm.
49609-12	11,8
49609-14	13,8

Stainless steel and natural wood.
Inox e legno naturale.



Spatula

Paletta
Teigschäber
Spatule
Espátula

art.	dim. cm.
49610-11	11x10,2
49610-14	13,3x12

Stainless steel and natural wood.
Inox e legno naturale.



Wok brush

Pennello per wok
Wok-Pinsel
Pinceaux à wok
Pincel para wok

art.	l. cm.
49634-00	31

B



PIZZA

ETHNIC CUISINE
CUCINA ETNICA





SS

Oil pourer

Oliera
Ölkanne
Huilière
Alcuza

art.	lt.
41780-05	0,50
41780-07	0,75
41780-09	1,00



Pizza peel, aluminum

Pala pizza, alluminio
Pizzaschaufel, Aluminium
Pelle à pizza, aluminum
Pala pizza, aluminio

art.	Ø cm.	l. cm.	gr.
11701-02	32	150	736
11701-06	37	150	870
11701-10	41	150	1226
11701-13	45	150	1460
11701-16	50	150	1604

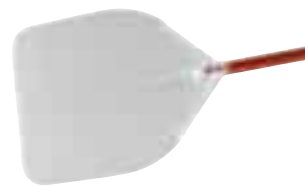

Pizza peel, aluminum

Pala pizza, alluminio
Pizzaschaufel, Aluminium
Pelle à pizza, aluminum
Pala pizza, aluminio

art.	cm.	l. cm.	gr.
11702-02	32x32	150	784
11702-06	37x37	150	894
11702-10	41x41	150	1246
11702-16	50x50	150	1694



Perforated pizza peel, aluminum

Pala pizza forata, alluminio
Pizzaschaufel, gelocht, Aluminium
Pelle à pizza perforée, aluminum
Pala pizza perforada, aluminio

art.	cm.	l. cm.	gr.
11704-02	32x32	150	700
11704-06	37x37	150	816
11704-13	45x45	150	1250
11704-16	50x50	150	1409



SS

Pizza peel, small

Palettino
Pizzaschaufel, klein
Petite pelle à pizza
Pala pizza, pequeña

art.	Ø cm.	l. cm.	gr.
11705-02	17	150	780
11705-06	20	150	846
11705-10	23	150	938
11705-14	26	150	984



SS

Perforated pizza peel, small

Palettino forato
Pizzaschaufel, gelocht, klein
Petite pelle à pizza perforée
Pala pizza perforada, pequeña

art.	Ø cm.	l. cm.	gr.
11706-02	17	150	770
11706-06	20	150	830
11706-10	23	150	912
11706-14	26	150	954



Oven pizza peel, aluminum

Pala per infornare, alluminio
Back-Pizzaschaufel, Aluminium
Pelle à enfourner, aluminum
Pala para hornear, aluminio

art.	cm.	l. cm.	gr.
41765-32	32x32	150	1200
41765-37	37x37	150	1400
41765-41	41x41	150	1500
41765-45	45x45	150	1600
41765-50	50x50	150	1700



SS

Oven pizza peel

Pala per infornare
Back-Pizzaschaufel
Pelle à enfourner
Pala para hornear

art.	Ø cm.	l. cm.	gr.
41735-29	29	150	870

Aluminum handle. – Manico alluminio.



Oven pizza peel, aluminum

Pala per infornare, alluminio
Back-Pizzaschaufel, Aluminium
Pelle à enfourner, aluminum
Pala para hornear, aluminio

art.	cm.	l. cm.	gr.
41736-32	32x30	150	954



SS

Perforated pizza peel, small

Palettino forato
Pizzaschaufel, gelocht, klein
Petite pelle à pizza perforée
Pala pizza perforada, pequeña

art.	Ø cm.	l. cm.	gr.
41737-17	17	150	890
41737-20	20	150	910
41737-23	23	150	960



SS

Pizza peel, small

Palettino
Pizzaschaufel, klein
Petite pelle à pizza
Pala pizza, pequeña

art.	Ø cm.	l. cm.	gr.
41738-17	17	150	905
41738-20	20	150	975
41738-23	23	150	1030



Pizza peel, small, aluminum

Palettino, alluminio
Pizzaschaufel, klein, Aluminum
Petite pelle à pizza, aluminum
Pala pizza, pequeña, aluminio

art.	Ø cm.	l. cm.	gr.
41735-20	20	150	800



W

Pizza peel

Pala pizza
Pizzaschaufel
Pelle à enfourner
Pala pizza

art.	Ø cm.	l. cm.
41764-33	33	200



SS

Ash shovel

Paletta cenere
Asche-Schaufel
Pelle à cendres
Paleta recogedar cenizas

art.	cm.	l. cm.
41768-21	21x31	173



SS

Rake

Rastrello
Harke
Râteau
Rastrillo

art.	cm.	l. cm.
41768-22	24x10	150



Adjustable brush

Spazzola orientabile
Drehbare Bürste
Brosse orientable
Cepillo orientable

art.	cm.	l. cm.
41767-20	20x6,5	155

Brass bristles. – Setole ottone.

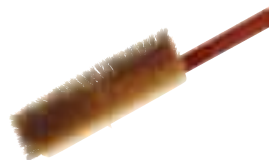

Adjustable brush

Spazzola orientabile
Drehbare Bürste
Brosse orientable
Cepillo orientable

art.	cm.	l. cm.
41766-27	27x7	150

Brass bristles. – Setole ottone.



Adjustable brush

Spazzola orientabile
Drehbare Bürste
Brosse orientable
Cepillo orientable

art.	cm.	l. cm.
41766-16	16x5	150

Brass bristles. – Setole ottone.



Adjustable brush

Spazzola orientabile
Drehbare Bürste
Brosse orientable
Cepillo orientable

art.	cm.	l. cm.
41766-14	14x7	150



Adjustable brush

Spazzola orientabile
Drehbare Bürste
Brosse orientable
Cepillo orientable

art.	cm.	l. cm.
41739-20	20x6,6	150



SS

Support for peels

Poggia pala pizza
Schaufelträger
Support pour pelles à pizza
Soporte palas

art.	cm.	fits/per
41769-36	40x16x39	max Ø 36
41769-50	52x16x34	max Ø 50



Small pizza peel wall rack, aluminum

Portapaletto da muro, alluminio
Pizzaschaufel-Wandgestell, Aluminum
Support mural petite pelle, aluminium
Soporte pala mural, aluminio

art. cm.
41769-02 32x10x5



Pizza peel wall rack, aluminum

Appendi pala da muro, alluminio
Pizzaschaufel-Wandgestell, Aluminum
Support mural pour pelle, aluminium
Soporte pala mural, aluminio

art. cm.
41769-01 17,5x9x9



Double-sided brush

Spazzola bi-facciale
Doppelseitige Bürste
Brosse double face
Cepillo doble

art. l. cm.
41761-02 100



SS

Pizza peel rack, marble base

Porta pale, base marmo
Schaufeln-Ständer, Marmorsockel
Support pour pelles, socle marbre
Soporte palas, pie marmol

art. cm.
41769-00 25x35x175

Double front. For peels H 150 cm.
Doppio fronte/retro. Per pale da 150 cm.



SS

Pizza peel rack, marble base

Porta pale, base marmo
Schaufeln-Ständer, Marmorsockel
Support pour pelles, socle marbre
Soporte palas, pie marmol

art. cm.
41769G00 25x35x233

Supplied WITHOUT peels. With Gluten Free sign.
Fornito SENZA pale. Con logo Gluten Free,



Adjustable brush

Spazzola orientabile
Drehbare Bürste
Brosse orientable
Cepillo orientable

art. cm. l. cm.
41767G20 20x6 160

Brass bristles. – Setole ottone.



Pizza peel, aluminum

Pala pizza, alluminio
Pizzaschaufel, Aluminum
Pelle à pizza, aluminium
Pala pizza, aluminio

art. cm. l. cm.
41704G33 33x33 150
41704G36 36x36 150



SS

Perforated pizza peel, small

Palettino forato
Pizzaschaufel, gelocht, klein
Petite pelle à pizza perforée
Pala pizza perforada, pequeña

art. Ø cm. l. cm.
41737G20 20 150
41737G23 23 150



SS

Pan gripper

Pinza per teglie
Pizzablech-Zange
Pince à plaques
Pinza fuente horns

art. l. cm.
42822-00 23



SS

Pan gripper

Pinza per teglie
Pizzablech-Zange
Pince à plaques
Pinza fuente horns

art.	l. cm.
18323-00	23



SS

Pizza cutter

Tronchetto tagliapizza
Pizzaschneider
Coupe-pizza
Cortador de pizza

art.	Ø cm.	l. cm.
18324-00	13,5	19



SS

Pizza wheel

Rotella taglia pizza
Pizzaschneider
Roulette à pizzas
Ruleta cortapizzas

art.	Ø cm.
18324-10	10



SS

Divisible pizza scissors

Forbice pizza smontabile
Pizzaschere, teilbar
Ciseaux à pizza, divisible
Tijeras para pizza desmontables

art.	l. cm.
18276-00	25



SS

Pizza knife

Coltello per pizzaiolo
Pizzamesser
Couteau à pizza
Cuchillo para pizza

art.	l. cm.
48280-45	23



SS

Perforated spatula

Paletta triangolare, forata
Palette, gelocht
Palette perforée
Pala triangular perforada

art.	cm.
18301-01	12x15



SS

Spatula

Paletta triangolare
Palette
Palette
Pala triangular

art.	cm.
18301-02	12x15



Peel with handle, aluminum

Pala manicata, alluminio
Schaufel mit Griff, Aluminum
Pelle avec manche, alu
Pala con mango, alluminio

art.	Ø cm.
42826-32	32
42826-37	37



SS

Perforated peel with handle

Pala manicata, forata
Schaufel mit Griff, gelocht
Pelle perforée avec manche
Pala con mango, perforada

art.	cm.
18302-01	22x18



SS

Peel with handle

Pala manicata
Schaufel mit Griff
Pelle avec manche
Pala con mango

art.	cm.
18302-02	22x18



W

Round platter

Vassoio rotondo
Buchenholzbrett, rund
Plateau rond
Bandeja redonda

art.	Ø cm.	h. cm.
41774-33	33	1,2

Beech wood. – Faggio.



W

Cutting board 1 portion

Tagliere monoporzione
Einzelportion Tablett
Planche mono-portion
Tabla monoporción

art.	cm.
41775-34	34x20x1,2

Beech wood. – Faggio.



MF

Round platter

Vassoio rotondo
Tablett, rund
Plateau rond

art.	Ø cm.	h. mm.
44473-02	33	0,8
44473-03	43	0,8



Pizza plate with wooden platter

Piatto pizza con tagliere legno
Pizzaplatte mit Holzbrett
Plat pizza avec planche bois
Fuente pizza con tabla madera

art.	Ø cm.
44232S16	16
44232S20	20

Enamelled cast iron plate.
Piatto in ghisa smaltata.



Pizza plate with wooden platter

Piatto pizza con tagliere legno
Pizzaplatte mit Holzbrett
Plat pizza avec planche bois
Fuente pizza con tabla madera

art.	Ø cm.
44233-20	20

Enamelled cast iron plate. Cups not include.
Piatto in ghisa smaltata. Ciotoline non include.

MODULAR SYSTEM BASE=LID EXTENSIBLE HEIGHT
SISTEMA MODULARE BASE=COPERCHIO ALTEZZA
ESTENSIBILE



The modular system where the base and lid are the same element. Rotation system allows the steam of hot pizzas to escape.

Sistema modulare, la base e coperchio sono lo stesso elemento. Dotato di sistema rotabile, per la fuoriuscita del vapore delle pizze calde.



PPE

Base and lid

Base e coperchio
Basis und Abdeckung
Base et couvercle
Base y tapa

art.	cm. ext.	int.
44975-50	57x57x9,5	51x51x6,3



PPE

Extender

Estensore
Aufsatz
Réhausse
Extensión

art.	cm. ext.	int.
44975H50	57x57x9,5	51x51x7,5x9,5



PPE

Insulated container

Contenitore isoteramico
Thermobehälter
Conteneur isotherme
Contenedor isotérmico

art.	cm.	lt.
44961-03	42x42x34,5	36

With steam release system. For pizza boxes max 36x36 cm. – Con sistema di rilascio del vapore. Per cartoni pizza max 36x36 cm.



PPE

Insulated container with handle

Contenitore isoteramico con maniglia
Thermobehälter mit Grill
Conteneur isotherme avec manche
Contenedor isotérmico con asa

art.	cm.	lt.
44961M03	42x42x34,5	36



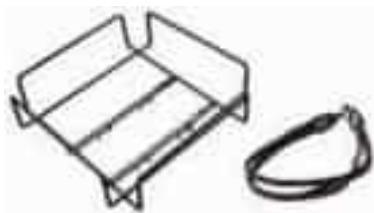

Bike basket rack + elastic hook

Cestello portapacco bike + gancio elastico
Fahrradträgerkorb + elastischer Haken
Porte-panier pour vélos + crochet élastique
Canasta para bicicletas + gancho elástico

art. cm.
44962-01 46x46x16

With 8 self-locking screws. Max platform capacity 25 kg. – Completo di 8 viti autobloccanti. Portata massima pianale 25 kg.



Pizza delivery bag

Borsa isotermica
Thermo-Tasche
Sac thermique
Bolsa térmica

art. cm. cap.
44960-01 55x50x20 3xø45



Pizza delivery bag

Borsa isotermica
Thermo-Tasche
Sac thermique
Bolsa térmica

art. cm. cap.
44960-04 46x44x20 4xø30



Pizza delivery bag

Borsa isotermica
Thermo-Tasche
Sac thermique
Bolsa térmica

art. cm. cap.
44960-06 34x34x19 5xø33
44960-07 42x42x19 4xø40



Pizza delivery bag

Borsa isotermica
Thermo-Tasche
Sac thermique
Bolsa térmica

art. cm. cap.
44960-02 46x46x12 2xø40
44960-03 50x51x11 2xø45



Sandwich delivery bag

Borsa isotermica
Thermo-Tasche
Sac thermique
Bolsa térmica

art. cm.
44960-13 39x27x30



Pizza delivery bag

Borsa isotermica
Thermo-Tasche
Sac thermique
Bolsa térmica

art. cm.
44960-10 51x46x41



Pizza delivery bag

Borsa isotermica
Thermo-Tasche
Sac thermique
Bolsa térmica

art. cm.
44960-11 48x48x70





Pizza delivery bag with rack
Borsa isoterma con rastrelliera
Thermo-Tasche mit Gestell
Sac thermique avec étagère
Bolsa térmica con rack

art.	cm.	cap.
44960K10	51x46x41	6xø45



Pizza delivery bag with rack
Borsa isoterma con rastrelliera
Thermo-Tasche mit Gestell
Sac thermique avec étagère
Bolsa térmica con rack

art.	cm.	cap.
44960K11	48x48x70	10xø45



Pizza delivery backpack
Zaino isotermaico
Thermo-Rucksack
Sac à dos thermique
Mochila térmica

art.	cm.
44962-05	45x45x38

Polyester and nylon. With inner PP insulataed container. For pizza boxes up to 35x35 cm. – Poliestere e nylon. Interno con contenitore isotermaico in PP. Per scatole pizza fino a 35x35 cm.



Pizza screen, aluminum
Retina pizza, alluminio
Pizzanetzscheibe, Aluminum
Toile à pizza, aluminium
Red para pizza, aluminio

art.	cm.
41734-60	60x40



Pizza screen, aluminum
Retina pizza, alluminio
Pizzanetzscheibe, Aluminum
Toile à pizza, aluminium
Red para pizza, aluminio

art.	Ø cm.
41727-28	28
41727-30	30
41727-33	33
41727-36	36
41727-40	40

Without seam. – Senza giunzione.



Pizza screen, aluminum
Retina pizza, alluminio
Pizzanetzscheibe, Aluminum
Toile à pizza, aluminium
Red para pizza, aluminio

art.	Ø cm.
41727-45	45
41727-50	50
41727-55	55
41727-60	60

Without seam. – Senza giunzione.



SS

Pizza screen rack
Rastrelliera per retine
Pizzanetzscheiben-Träger
Etagère à toiles
Rack para red para pizza

art. cm.
41771-96 23x35,6

Suitable for 96 screens.
Può contenere 96 retine.



SS

Pizza pan rack
Rastelliera per teglie pizza
Pizzableche-Träger
Etagère pour plaques à pizza
Rack para placas pizza

art. cm.
41770-15 30,5x30,5x70

Rails h.3,5 cm. for sheets up to Ø 36 cm.
Distanza piani cm 3,5, per teglie max ø 36 cm.



Baking tray, alusteel
Teglia forno, acciaio alluminato
Backblech mit Aluminiumüberzug
Plaque à pizza, tôle aluminée
Placa pizza, acero aluminizado

art.	Ø cm.	h. cm.	U. Pack
11739-20	20	2,5	10
11739-24	24	2,5	10
11739-28	28	2,5	10
11739-32	32	2,5	10



Pizza pan, heavy blue steel
Teglia pizza, ferro blu pesante
Pizzablech, Blaublech, Schwerausführung
Plaque à pizza, tôle forte bleuie
Placa pizza, hierro pesante

art.	Ø cm.	h. cm.	U. Pack
11744-20	20	2,5	10
11744-24	24	2,5	10
11744-28	28	2,5	10
11744-32	32	2,5	10



Pizza pan, perforated, non stick coated
Teglia pizza forata, antiaderente
Pizzablech, gelocht, beschichtet
Plaque à pizza perforée, anti-adhésive
Placa pizza perforada, antiaderente

art.	Ø cm.	h. cm.
41729-30	29/27	1,5
41729-34	33/30	1,5



Pizza pan double non stick-coating
Teglia pizza, antiaderente a 2 strati
Pizzablech mit Doppel-Beschichtung
Plaque à pizza, double revêtement
Placa pizza antiaderente, 2 capas

art.	Ø cm.	h. cm.	U. Pack
11741-20	20	2,5	5
11741-24	24	2,5	5
11741-26	26	2,5	5
11741-28	28	2,5	5
11741-32	32	2,5	5

Heat resistant up to 280°C. – Resistente a 280 °C.



Pizza pan, blue steel
Teglia pizza, ferro blu
Pizza-Blaublech
Plaque à pizza, tôle bleuie
Placa pizza, hierro

art.	Ø cm.	h. cm.	U. Pack
11740-14	14	2,5	5
11740-16	16	2,5	5
11740-18	18	2,5	5
11740-20	20	2,5	5
11740-22	22	2,5	5
11740-24	24	2,5	5



Pizza pan, blue steel
Teglia pizza, ferro blu
Pizza-Blaublech
Plaque à pizza, tôle bleuie
Placa pizza, hierro

art.	Ø cm.	h. cm.	U. Pack
11740-26	26	2,5	5
11740-28	28	2,5	5
11740-30	30	2,5	5
11740-32	32	2,5	5
11740-36	36	2,5	5
11740-40	40	2,5	5



Pizza pan, blue steel
Teglia pizza, ferro blu
Pizza-Blaublech
Plaque à pizza, tôle bleuie
Placa pizza, hierro

art.	Ø cm.	h. cm.	U. Pack
11742-16	16	3,5	10
11742-18	18	3,5	10
11742-20	20	3,5	10
11742-22	22	3,5	10
11742-24	24	3,5	10
11742-26	26	3,5	10
11742-28	28	3,5	10



Pizza pan, blue steel

Teglia pizza, ferro blu
Pizza-Blaublech
Plaque à pizza, tôle bleuie
Placa pizza, hierro

art.	Ø cm.	h. cm.	U. Pack
11742-30	30	3,5	10
11742-32	32	3,5	5
11742-36	36	3,5	5
11742-40	40	3,5	5
11742-45	45	4,0	5
11742-50	50	4,0	5
11742-60	60	4,0	5



Baking tray, blue steel, rectangular

Teglia rettangolare, ferro blu
Blaublech, rechteckig
Plaque rectangulaire, tôle bleuie
Placa rectangular, hierro

art.	cm.	h. cm.
41745-30	30x23	3
41745-35	35x28	3
41745-40	40x30	3
41745-50	50x35	3
41745-60	60x40	3
41745-65	65x45	3



Baking tray, alusteel

Teglia, alluminata
Backblech, Aluminiumüberzug
Plaque rectangulaire, tôle aluminitée
Placa rectangular, acero aluminizado

art.	cm.	h. cm.
41746-60	60x40	2



Baking tray, alusteel

Teglia, alluminata
Backblech, Aluminiumüberzug
Plaque rectangulaire, tôle aluminitée
Placa rectangular, acero aluminizado

art.	cm.	h. cm.
41751-30	30x23	3
41751-35	35x28	3
41751-40	40x30	3
41751-50	50x35	3
41751-60	60x40	3
41751-65	65x45	3



Baking tray, aluminum

Teglia, alluminio
Backblech, Aluminium
Plaque à cuisson, aluminium
Placa pastelería, aluminio

art.	cm.	GN
41744-32	53x32,5	1/1
41744-53	53x65	2/1
41744-60	60x40	-



Baking tray perforated, aluminum

Teglia forata, alluminio
Backblech, gelocht, Aluminium
Plaque perforée, aluminium
Placa perforada, aluminio

art.	cm.
41756-30	30x40
41756-32	53x32,5
41756-53	53x65
41756-60	60x40



Baking tray, non stick coated

Teglia antiaderente
Blech mit Antihafbeschichtung
Plaque avec revêtement anti-adhésif
Placa antiadherente

art.	cm.	h. cm.
41747-60	60x40	2

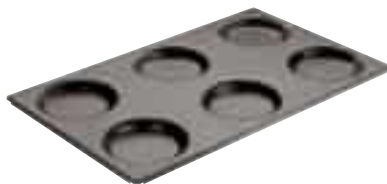

Baking tray, non stick coated

Teglia antiaderente
Blech mit Antihafbeschichtung
Plaque avec revêtement anti-adhésif
Placa antiadherente

art.	Ø cm.	GN	pcs/pz
41755-11	12,5	1/1	6



Baking tray, silicone coated

Teglia siliconata
Backblech Silikonbeschichtet
Plaque avec revêtement silicone
Placa siliconada

art.	cm.	GN
41743D32	53x32,5	1/1
41743D53	53x65	2/1
41743D60	60x40	-



Baking tray perforated, silicone coated

Teglia forata, siliconata
Backblech, gelocht, Silikonbeschichtet
Plaque perforée, revêtement silicone
Placa perforada, siliconada

art.	cm.	GN
41753D30	30x40	-
41753D32	53x32,5	1/1
41753D53	53x65	2/1
41753D60	60x40	-

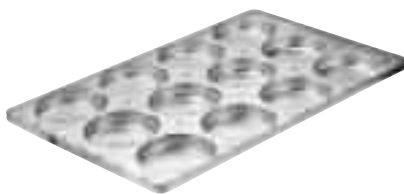

Baking tray, alusteel

Teglia, alluminata
Backblech, Aluminumüberzug
Plaque, tôle aluminitée
Placa, acero aluminizado

art.	Ø cm.	cm.	pcs/pz
41752-08	14	60x40	8
41752-12	12	60x40	12
41752-24	12	60x80	24



PP
SS

Dough scraper, flexible

Tagliapasta flessibile
Abstecher, flexibele
Raclette flexible
Cortapastas flexible

art.	cm.
18501-02	12x9,5



PP
SS

Dough scraper

Tagliapasta
Abstecher
Raclette
Cortapastas

art.	cm.
18501-01	12x16
18501-03	13,5x10
18501-04	12x9,5



PP
SS

Dough scraper

Raschia
Teigschäber
Raclette
Rasqueta

art.	cm.
18501-05	11x19,5



PP
SS

Dough scraper

Raschia
Teigschäber
Raclette
Rasqueta

art.	cm.
18502-18	18x9



PP
SS

Dough scraper

Raschia
Teigschäber
Raclette
Rasqueta

art.	cm.
18503-12	12x10



PP
SS

Dough scraper

Raschia
Teigschäber
Raclette
Rasqueta

art.	cm.
18504-15	15x7,5



PP
SS

Dough scraper

Raschia
Teigschäber
Raclette
Rasqueta

art.	cm.
18520-15	15x6



PA+
plus

Pizza ladle, flat bottom

Mestolo pizza, fondo piatto
Schöpflöffel, flachboden
Louche fond plat
Cacillo fondo plano

art.	Ø cm.	l. cm.
12968-10	10	27



PS

Dough cutter

Tagliapasta
Teigschäber
Raclette
Rascador

art.	cm.
47621-11	10x24

Shock and scratchproof material. Do not use on heat sources. – Materiale antiurto e antigraffio. Non usare su fonti di calore.



PS

Dough cutter

Tagliapasta
Teigschäber
Raclette
Rascador

art.	cm.
47621-12	13,5x14,5

Shock and scratchproof material. Do not use on heat sources. – Materiale antiurto e antigraffio. Non usare su fonti di calore.



PE

Dough box

Contentore per impasti
Behälter für Pizzateig
Récipliant à pétrissage
Contenedor para masa de pizza

art.	cm.	lt.
41762-07	60x40x7,5	14
41762-09	60x40x9,5	19
41762-13	60x40x13	26



PE

Cover for dough box

Coperchio per contenitore
Deckel für Pizzateig-Behälter
Couvercle pour récipliant à pétrissage
Tapa para contenedor

art.	cm.
41763-00	60x40



COFFEE SHOP CAFFETTERIA

BAR HAPPY HOUR





Set 2 double wall espresso cups
Set 2 tazze espresso doppia parete
Set 2 Doppelwandigen Espressotassen
Set 2 tasses espresso double paroi
Juego 2 tazas doble pared espresso

art.	Ø cm.	h. cm.	ml.
41202-01	6	7,5	100

Borosilicate glass. – Vetro borosilicato.



Set 2 double wall capuccino cups
Set 2 tazze capuccino doppia parete
Set2 Doppelwandigen Cappuccinotassen
Set 2 tasses capuccino double paroi
Juego 2 tazas doble pared capuchino

art.	Ø cm.	h. cm.	ml.
41202-02	7,5	9,5	200

Borosilicate glass. – Vetro borosilicato.



Teapot with infuser
Teiera con infusore
Teekanne mit Infuser
Théière avec infuseur
Tetera con infusor

art.	Ø cm.	h. cm.	ml.
41203-01	14	12	900

Borosilicate glass. Stainless steel infuser. – Vetro borosilicato. Infusore inox.



Pour over coffee maker with filter
Caffettiera pour over con filtro
Pour Over Kaffeebereiter mit Filter
Cafetière pour over avec filtre
Cafetera pour over con filtro

art.	Ø cm.	h. cm.	ml.
41203-11	8,5-11	21	600

Borosilicate glass. Bamboo collar. St/steel filter.
Vetro borosilicato. Collo bambù. Filtro inox.



Nitro Whip

Sifone nitro
Nitrobereiter
Siphon à nitro
Sifón para Nitro

art.	lt.	des.
41452N10	1	Whip/Sifone
41452N16	-	16 chargers/ricariche

Nitro Brew is on one of the fastest growing trends in the coffee business. Offer Nitro Coffee, Nitro Tea, and Nitro Cocktails to delight your guests table/barside. Adding Nitrogen (N2) to cold brew coffee and cocktails initiates a spectacular cascading effect, making the beverage unique, attractive, and personal. Nitrogen creates a velvety creamy texture and a long lasting foamy head for brews and cocktails. – Infusi Nitro è una delle tendenze in rapida crescita nel settore del caffè. Offri Nitro Caffè, Nitro Te e Nitro Cocktails per deliziare i tuoi ospiti. Aggiungendo l'azoto (N2) per preparare caffè e cocktail a freddo, viene avviato uno spettacolare effetto a cascata, rendendo la bevanda unica, attraente e personale. L'azoto crea una consistenza vellutata e cremosa e una spuma di lunga durata per infusi e cocktail.



Set of 10 stencils, plastic
Kit 10 mascherine, plastica
Satz 10 Masken, kunststoff
Set 10 pcs masques, plastique
Juego 10 máscaras, plástico

art.	Ø cm.	h. cm.	lt.
47859-01	10	16	0,25



Set of 10 stencils, plastic
Kit 10 mascherine, plastica
Satz 10 Masken, kunststoff
Set 10 pcs masques, plastique
Juego 10 máscaras, plástico

art.	Ø cm.
47859-02	10



Set of 4 stencils, plastic
Kit 4 mascherine, plastica
Satz 4 Masken, kunststoff
Set 4 pcs masques, plastique
Juego 4 máscaras, plástico

art.	Ø cm.
47859-03	10



Cocoa duster kit

Kit spargicacao
Kakaostreuer-Set
Set glacière à cacao
Juego dosificador cacao

art.	Ø cm.	h. cm.
42923-07	6,5	13



Cocoa dredger

Spargicacao
Kakaostreuer
Saupoudreuse à cacao
Coctelera de cacao

art.	Ø cm.	h. cm.	ml.
41607-00	5,5	7,5	160



Sugar pourer

Spargizucchero
Zuckerstreuer
Saupoudreuse à sucre
Dispensador de azúcar

art.	Ø cm.	Ø mm.	ml.
47023-01	7	1,5	300
47023-02	7	2,5	300
47023-03	7	5	300
47023-04	7	mesh	300



Sugar pourer

Spargizucchero
Zuckerstreuer
Saupoudreuse à sucre
Dispensador azúcar

art.	Ø cm.	h. cm.	ml.
41525-01	8	15	250



Sugar pourer

Spargizucchero
Zuckerstreuer
Saupoudreuse à sucre
Dispensador azúcar

art.	Ø cm.	h. cm.	ml.
42920-02	7,5	13,5	320



Sugar pourer

Spargizucchero
Zuckerstreuer
Saupoudreuse à sucre
Dispensador azúcar

art.	Ø cm.	h. cm.	ml.
41645-00	7,5	17	320



Honey/cream dispenser

Dosatore miele/cremiera
Sahne-/Honigkännchen
Doseur pour miel/lait
Dosificador para miel/leche

art.	Ø cm.	h. cm.	ml.
41525-00	8,5	13,5	300



Milk frothing thermometers, 3 pcs

Termometri latte/barista, 3 pz
Mich-Thermometer, 3 Stk
Thermomètres à lait, 3 pièces
Termómetros leche, 3 pz

art.	Ø cm.	scala	range
49709-03	4,5	1°C	-10+110°C

Red, green and blue, to easily identify different types of milk used, to avoid cross-contamination. Stem 175 mm. – Rosso, verde e blu, per identificare facilmente i diversi tipi di latte utilizzati, per evitare la contaminazione incrociata. Stelo 175 mm.



Milk pot with lid

Lattiera con coperchio
Milchgießer mit Deckel
Pot à lait avec couvercle
Jarra leche con tapa

art.	lt.
66303-01	0,15
66303-03	0,30
66303-06	0,60



Cappuccino milk pot

Lattiera cappuccino
Capuccino-Milchkanne
Pot à cappuccino
Jarra cappuccino

art.	lt.
66307-06	0,6
66307-09	0,9
66307-12	1,2



Spoon holder

Porta cucchiaini
Kaffeelöffelbehälter
Porte cuillères
Porta cucharas

art.	Ø cm.	h. cm.
66313-03	6	9

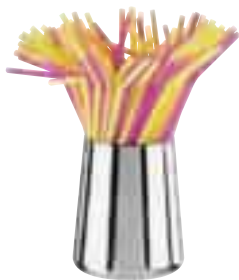

SS

Straw holder

Porta cannucce
Röhrchenbehälter
Porte chalumeaux
Porta pajitas

art.	Ø cm.	h. cm.
66313-06	8	12



NEW

SS

W

Milk & sugar set 5 pcs

Latte & zucchero, set 5 pezzi
Milch- und Zucker-Set 5 Stk
Set lait et Sucre, 5 pièces
Set leche y azúcar 5 piezas

art.	dim. cm.
41537-00	19x10x10,5

Stainless steel PTFE coated. Acacia wood.



NEW

SS

QD

Milk jug

Lattiera
Milchkanne
Pot à lait
Jarra leche

art.	Ø cm.	h. cm.	lt.
41537-03	8,0	10,0	0,35
41537-06	9,0	11,5	0,60
41537-08	10,5	13,0	0,80

PTFE coated.



SS

Sugar packet holder

Portabustine zucchero
Zuckertütenschale
Porte-sachet de sucre
Porta sobres de azúcar

art.	dim. cm.
66374-00	13x6x4



PR

Sugar packet holder

Portabustine zucchero
Zuckertütenschale
Porte-sachet de sucre
Porta sobres de azúcar

art.	dim. cm.
67303-64	11x6x4



Sugar packet holder

Portabustine zucchero
Zuckertütenschale
Porte-sachet de sucre
Porta sobres de azúcar

art.	dim. cm.	col.
44104-01	8,5x6,5x5	●
44104-02	8,5x6,5x5	○



AY

Tea-box

Scatola portabustine thè
Teebox
Boîte à sachets de thé
Caja para bolsitas de tè

art.	dim. cm.
41614-22	22x17x9



W

Tea-box

Scatola portabustine thè
Teebox
Boîte à sachets de thé
Caja para bolsitas de tè

art.	dim. cm.
41614-33	33,5x20x9
41614-35	31x28x9



W

Tea-box

Scatola portabustine thè
Teebox
Boîte à sachets de thé
Caja para bolsitas de tè

art.	dim. cm.
41614-34	33,5x20x9
41614-36	31x28x9



PMMA

Box With Lid

Contenitore con coperchio
Behälter mit Deckel
Boîte avec couvercle
Recipiente con tapa

art.	dim. cm.
41472-25	27,5x10,5x9,5

Single compartment 8,5x8 cm.
Singolo scomparto 8,5x8 cm.



PMMA

Napkin holder

Portatovaglioli
Serviettenhalter
Porte serviettes
Servilletero

art.	dim. cm.
41472-12	18x6x10



PMMA

Napkin holder

Portatovaglioli
Serviettenhalter
Porte serviettes
Servilletero

art.	dim. cm.
41472-13	18x6x11

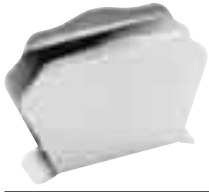

SS

Napkin holder
Portatovaglioli
Serviettenhalter
Porte serviettes
Servilletero

art.	dim. cm.
66391-00	10x3x8



SS

Napkin holder
Portatovaglioli
Serviettenhalter
Porte serviettes
Servilletero

art.	dim. cm.
41602-00	17x3x7



SS

Napkin holder
Portatovaglioli
Serviettenhalter
Porte serviettes
Servilletero

art.	dim. cm.
41601-17	8,5x11x12,5



Napkin holder, chrome plated wire
Portatovaglioli in filo cromato
Serviettenhalter, Metall verchromt
Porte-serviettes en fil chromé
Servilletero en hilo cromado

art.	dim. cm.
41617-05	19x19x6,5



Napkin holder, chrome plated wire
Portatovaglioli in filo cromato
Serviettenhalter, Metall verchromt
Porte-serviettes en fil chromé
Servilletero en hilo cromado

art.	dim. cm.
41617-15	19x19x19



Napkin holder, chrome plated wire
Portatovaglioli in filo cromato
Serviettenhalter, Metall verchromt
Porte-serviettes en fil chromé
Servilletero en hilo cromado

art.	dim. cm.
41618-14	14x14x6,5



Cash tray, 18 Cr s/s
Vassoio conto, inox 18 Cr
Rechnungstablent, Edelstahl 18 Cr
Plateau porte-monnaie, inox 18 Cr
Bandeja cuentas, acero 18 Cr

art.	dim. cm.
66318-19	19x14
66318-22	22x15



SS

Pastry stand 2-tier
Alzata dolci, 2 piani
Gebäckständer, 2-stufig
Serviteur muet 2 étages
Soporte dulces 2 niveles

art.	Ø cm.	h. cm.
66339-02	12/16	20



Serving stand, chrome plated
Alzata cromata
Serviergestell, Metall hartverchromt
Présentoir chromé
Soporte platos cromado

art.	dim. cm.
42962-26	18,5x15,5x26

For 3 plates max. Ø 17 cm, inside Ø 10,5 cm.
Per 3 piatti max. Ø 17 cm, interno Ø 10,5 cm.



Serving stand

Alzata
Serviergestell
Présentoir
Soporte platos

art. dim. cm.
42962C26 18,5x15,5x26

For 3 plates max. Ø 17 cm, inside Ø 10,5 cm.
Per 3 piatti max. Ø 17 cm, interno Ø 10,5 cm.



W

Coffee set 4 pieces

Servizio caffè 4 pezzi
Kaffeeset 4 Stk
Service à café 4 pièces
Servicio de café 4 piezas

art. dim. cm.
41206-03 25x18,7x2,5

Acacia wood. – Acacia.



Serving stand 2-tier

Alzata 2 piani
Serviergestell, 2-stufig
Présentoir 2 étages
Soporte 2 niveles

art. dim. cm.
41208-06 31x17x38

Black metal frame with non-slip feet, 2 baskets 29x16x7 cm, 2 acacia wood boards 28,5x15,5x1,5 cm. – Struttura in metallo nero con piedini antiscivolo, 2 cesti cm 29x16x7, 2 assi in legno di acacia cm 28,5x15,5x1,5.



Serving stand 2-tier

Alzata 2 piani
Serviergestell, 2-stufig
Présentoir 2 étages
Soporte 2 niveles

art. Ø cm. h. cm.
41208-02 22/26 48

Wooden handle, metal black baskets Ø 22 H 6 cm and Ø 26 H 8 cm. – Manico legno, cesti in metallo nero Ø 22 H 6 cm e Ø 26 H 8 cm.



SS

Cake stand

Alzata torta
Tortenplatte
Gueridon pâtissier
Pedestal para tartas

art. Ø cm. h. cm.
41538-30 30 5



SS

Cake stand

Alzata torta
Tortenplatte
Gueridon pâtissier
Pedestal para tartas

art. Ø cm. h. cm.
47099-30 30 10



SS

Swivel cake stand

Alzata torta girevole
Tortenplatte drehbar
Gueridon pâtissier tournante
Pedestal giratorio para tartas

art. Ø cm. h. cm.
47101-31 30,5 9

Rotating plate. Fits to: 41414-31.
Piatto rotante. Per art.: 41414-31.



MF

Cake stand

Alzata torta
Tortenplatte
Gueridon pâtissier
Pedestal para tartas

art. dim. cm.
44874-08 31x31x8
44874-16 31x31x16



PS

Dome cover

Cloche
Abdeckhaube
Cloche
Campana

art. Ø cm. h. cm.
41414-30 30 9,5

Fits to/Per art.: 44845-31, 47101-31, 44873-08, 44873-16.





MF

Cake tray

Piatto torta
Tortenplatte
Plat gâteau
Bandeja pasteles

art.	Ø cm.	h. cm.
44845-31	31,0	3,5

With non-slip feet. With carved edge fixing the cover. – Con piedini antiscivolo. Con bordo fissacoperchio.



MF

Cake stand

Alzata torta
Tortenplatte
Gueridon pâtissier
Pedestal para tartas

art.	Ø cm.	h. cm.
44873-08	30,5	9

With non-slip feet. With carved edge fixing the cover. – Con piedini antiscivolo. Con bordo fissacoperchio.



MF

Cake stand

Alzata torta
Tortenplatte
Gueridon pâtissier
Pedestal para tartas

art.	Ø cm.	h. cm.
44873-16	30,5	17

With non-slip feet. With carved edge fixing the cover. – Con piedini antiscivolo. Con bordo fissacoperchio.



PC

Dome cover

Campana
Haube
Cloche
Campana

art.	Ø cm.	h. cm.
41414-21	21	17

Fits to/Per art.: 44474-24, 44474-25.



PC

Dome cover

Campana
Haube
Cloche
Campana

art.	Ø cm.	h. cm.
41414-31	30	22

Fits to/Per art.: 41586-33, 41587-32, 44475-79, 44845-31, 44873-08, 44873-16, 47101-31, 44474-33, 44474-34.



PC

Dome cover

Campana
Haube
Cloche
Campana

art.	Ø cm.	h. cm.
41414-36	36	27

Fits to/Per art.: 44474-38, 44474-39, 44470-38.



PC

Dome cover

Campana
Haube
Cloche
Campana

art.	Ø cm.	h. cm.
41413-30	30	40

Fits to/Per art.: 44845-31, 44873-08, 44873-16, 44474-33, 44474-34.





Cake stand
Alzata torta
Tortenplatte
Gueridon pâtissier
Pedestal para tartas

art.	Ø cm.	h. cm.
44474-09	9,5	7
44474-13	13,0	9

Acacia wood. – Legno d'acacia.



Dome cover
Cloche
Abdeckehaube
Cloche
Campana

art.	Ø cm.	h. cm.	fits/per
41414-10	10	10	44474-13



Cake stand
Alzata torta
Tortenplatte
Gueridon pâtissier
Pedestal para tartas

art.	Ø cm.	h. cm.	fits/per
44474-24	24	8	41414-21
44474-33	33	8	41414-31
44474-38	38,5	8	41414-36

Acacia wood. – Legno d'acacia.



Cake stand
Alzata torta
Tortenplatte
Gueridon pâtissier
Pedestal para tartas

art.	Ø cm.	h. cm.	fits/per
44474-25	24	16	41414-21
44474-34	33	16	41413-30
44474-39	38,5	16	41414-36

Acacia wood. – Legno d'acacia.



Cake plate
Piatto torta
Tortenplatte
Plat à gâteau
Plato pastel

art.	Ø cm.	h. cm.
41445-11	30	2,0

Oak. With non-slip feet.
Quercia. Con piedini antiscivolo.



Dome cover
Cloche
Abdeckehaube
Cloche
Campana

art.	Ø cm.	h. cm.
41420-30	30	11,5

Fits to / Per art.: 41445-11, 44470-31.





PS

Dome cover

Cloche
Abdeckhaube
Cloche
Campana

art.	Ø cm.	h. cm.
41420-31	30	11,5

Chrome plated knob. – Pomolo cromato.



B

PS

Tray with cover

Tagliere con cloche
Servierbrett mit Abdeckhaube
Planche avec cloche
Tabla con campana

art.	dim. cm.
41416-24	24x18,5x8



B

PS

Tray with cover

Tagliere con cloche
Servierbrett mit Abdeckhaube
Planche avec cloche
Tabla con campana

art.	dim. cm.
41416-32	32x16,5x11



B

PS

Tray with cover

Tagliere con cloche
Servierbrett mit Abdeckhaube
Planche avec cloche
Tabla con campana

art.	Ø cm.	h. cm.
41416-20	20,5	10,0



W

SAN

Tray with cover

Tagliere con cloche
Servierbrett mit Abdeckhaube
Planche avec cloche
Tabla con campana

art.	Ø cm.	h. cm.
41416-25	25	13,5



W

SAN

Tray with cover

Tagliere con cloche
Servierbrett mit Abdeckhaube
Planche avec cloche
Tabla con campana

art.	dim. cm.
41416-28	28x14x11,5



W

Tray with dome cover

Vassoio con campana
Tablett mit Haube
Plat avec cloche
Bandeja con campana

art.	Ø cm.	h. cm.
41416-18	18,5	24,5

Glass cover Ø 16 H 22,5 cm.

Cloche in vetro Ø 16 H 22,5 cm.



NEW

SS

PS

Tray with cover

Vassoio con cloche
Tablett mit Haube
Plateau avec cloche
Bandeja con campana

art.	dim. cm.
41422-42	42x31x8,5



NEW

SS

PS

Tray with cover

Vassoio con cloche
Tablett mit Haube
Plateau avec cloche
Bandeja con campana

art.	Ø cm.	h. cm.
41422-38	38	12,0



NEW

SS

SAN

Tray with cover
Vassoio con cloche
Tablett mit Haube
Plateau avec cloche
Bandeja con campana

art.	Ø cm.	h. cm.
41422-27	27	12,5



NEW

SS

SAN

Tray with cover
Vassoio con cloche
Tablett mit Haube
Plateau avec cloche
Bandeja con campana

art.	dim. cm.
41422-30	30x15,5x10,5



NEW

SS

PS

Tray with cover
Vassoio con cloche
Tablett mit Haube
Plateau avec cloche
Bandeja con campana

art.	dim. cm.
41422-25	25x19x7



NEW

SS

PS

Tray with cover
Vassoio con cloche
Tablett mit Haube
Plateau avec cloche
Bandeja con campana

art.	dim. cm.
41422-33	33x17x10



PMMA

Display case
Vetrina brioches
Vitrine für Brioches
Vitrine brioches
Vitrina brioches

art.	dim. cm.
41472-32	37x31x31

1 door, 3 shelves, H 10 cm.
1 porta, 3 piani H 10 cm.



AY

PP

Sweet box
Contenitore universale
Universalbox
Boîte à comptoir
Exibidor

art.	dim. cm.
47090-23	23x14,5x15



NEW

PS

Showcase
Vetrina da banco
Vitrine für Verkaufstheke
Vitrine à comptoir
Vitrina

art.	dim. cm.
47092-01	40x30x18

Double side opening. – Apertura doppio fronte.



NEW

PS

Showcase, 2-tier
Vetrina da banco, 2 piani
Vitrine für Verkaufstheke, doppeldecker
Vitrine à comptoir, 2 étages
Vitrina, doble

art.	dim. cm.
47092-02	45x30x43

Double side opening. – Apertura doppio fronte.

ICE CREAM GELATERIA

BAR HAPPY HOUR





SS

Ice cream container

Bacinella per gelato
Eisbehälter
Réceptient à glace
Cubeta helado

art.	dim. cm.	lt.
41487-12	26x16x12	3,5
41487-15	26x16x15	4,1
41487-17	26x16x17	4,5



SS

Ice cream container

Bacinella per gelato
Eisbehälter
Réceptient à glace
Cubeta helado

art.	dim. cm.	lt.
41471-12	36x16,5x12	5,0
41471-15	36x16,5x15	6,5
41471-17	36x16,5x17	7,5



SS

Ice cream container

Bacinella per gelato
Eisbehälter
Réceptient à glace
Cubeta helado

art.	dim. cm.	lt.
41486-08	36x25x8	5
41486-12	36x25x12	8
41486-15	36x25x15	10



PC

Ice cream container

Bacinella per gelato
Eisbehälter
Réceptient à glace
Cubeta helado

art.	dim. cm.	lt.
41431-12	36x16,5x12	5,4



PC

Ice cream container

Bacinella per gelato
Eisbehälter
Réceptient à glace
Cubeta helado

art.	dim. cm.	lt.
41431-08	36x25x8	5,0



PMMA

Lid for ice cream container

Coperchio per bacinella gelato
Deckel für Eisbehälter
Couvercle pour réceptient à glace
Tapa para cubeta helado

art.	dim. cm.
41471-00	36x16,5



PC

Lid for ice cream container

Coperchio per bacinella gelato
Deckel für Eisbehälter
Couvercle pour réceptient à glace
Tapa para cubeta helado

art.	dim. cm.
41486-00	36x16,5
41486-01	36x25



SS

Ice cream basin

Carapina
Eisbehälter
Réceptient à glace
Cubeta helado

art.	Ø cm.	h. cm.	lt.
41489-20	20	25	7,3



SS

Ice cream server

Spatola gelato carapina
Eisspachtel
Palette à glace
Paleta helados

art.	col.
41475-20	○



SS

Ice cream server

Spatola gelato
Eisspachtel
Palette à glace
Paleta helados

art.	l. cm.	col.
41475-00	27	○
41475-01	27	●
41475-03	27	●
41475-04	27	●
41475-05	27	●



Ice-dipper

Spatola gelato
Eisdipper
Cuillère à glace
Cuchara helados

art.	Ø mm.	lt.
41468-20	55	1/20
41468-24	50	1/24

With liquid heat conductor in the handle.
Con liquido conduttore nel manico.



Ice-dipper

Spatola gelato
Eisdipper
Cuillère à glace
Cuchara helados

art.	Ø mm.	lt.
41469-20	55	1/20
41469-24	50	1/24

With liquid heat conductor in the handle.
Con liquido conduttore nel manico.



SS

Ice cream scoop
Porzionatore
Eisportionierer
Cuillère à glace
Racionador de helado

art.	Ø mm.	lt.
41476-50	50	1/24

Non slip handle. – Manico antiscivolo.

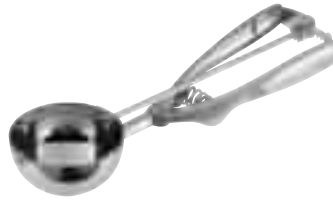

SS

Ice cream scoop
Porzionatore
Eisportionierer
Cuillère à glace
Racionador de helado

art.	Ø mm.	lt.
41473-31	30	1/100
41473-39	38	1/65
41473-44	43	1/50
41473-50	50	1/24
41473-56	55	1/20
41473-62	60	1/14
41473-66	66	1/12

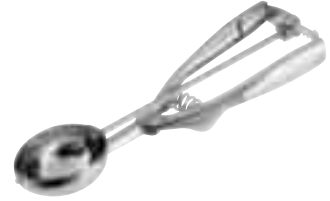

SS

Oval ice cream scoop
Porzionatore ovale
Eisportionierer, oval
Cuillère à glace ovale
Racionador de helado oval

art.	Ø mm.	lt.
41474-00	60	1/30



SS

Triangle ice cream scoop
Porzionatore triangolare
Eisportionierer, dreieckig
Cuillère à glace triangle
Racionador de helado triangular

art.	lt.
41474-02	1/30



Decorative scrapers 5 pcs
Raschietti decorativi 5 pezzi
Dekorative Schaber 5 Stk
Raclettes décoratives 5 pcs
Rasquetas decorativas 5 pz

art.	dim. cm.
41472-43	14,5x15

PETG.



PMMA

Counter ice cream cone holder
Porta coni da banco
Theke-Eiswaffelständer
Porte cornets à glace de comptoir
Expositor para cucuruchos

art.	Ø mm.	dim. cm.
41472-07	3,5	21x8,5x11
41472-08	3,5	28,5x8,5x11



SS

Counter ice cream cone holder
Porta coni da banco
Theke-Eiswaffelständer
Porte cornets à glace de comptoir
Expositor para cucuruchos

art.	Ø cm.	h. cm.
41472-04	16,5	14



SS

Counter ice cream cone holder

Porta coni da banco
Theke-Eiswaffelständer
Porte cornets à glace de comptoir
Expositor para cucuruchos

art. dim. cm.
41472-01 20x9,5x8,5



PMMA

Flavour marker holder 10 pcs

Porta segnagusto 10 pezzi
Eisschilderhalter 10 Stk
Porte-etiquettes 10 pièces
Porta etiquetas 10 pz

art. mm.
41472-46 87x52

Labels not included. – Cartellino non incluso.



PMMA

Flavour marker 10 pcs

Segnagusto 10 pezzi
Eisschilder 10 Stk
Etiquettes 10 pièces
Etiquetas sabores 10 pz

art. mm.
41472-45 150x70



PMMA

Flavour marker 10 pcs

Segnagusto 10 pezzi
Eisschilder 10 Stk
Etiquettes 10 pièces
Etiquetas sabores 10 pz

art. mm.
41472-44 190x85



Chalkmarker

Penna a gesso liquido
Kreidestifte
Stylo à craie liquide
Marcadores de tiza líquida

art. col.
47832-01 ●
47832-03 ●
47832-04 ●
47832-05 ●

Writes on all non porous surfaces. Clean with water. – Scrive su tutte le superfici non porose. Pulire con acqua.



PMMA

Paper napkins holder

Porta tovaglioli
Serviettenhalter
Porte serviettes
Porta servilletas

art. dim. cm.
41472-12 18x6x10



PMMA

Paper napkins holder

Porta tovaglioli
Serviettenhalter
Porte serviettes
Porta servilletas

art. dim. cm.
41472-13 18x6x11



AY
PP

Universal box

Contentitore universale
Universalbox
Conteneur à comptoir
Recipiente universal

art. dim. cm.
47090-23 23x14,5x15



PMMA

Box with lid

Contentitore con coperchio
Behälter mit Deckel
Boîte avec couvercle
Recipiente con tapa

art. dim. cm.
41472-25 27,5x10,5x9,5

Compartments size 8,5x8 cm. – Dimensione scomparti 8,5x8 cm.



PMMA

Waffle case

Contentitore per cialde
Waffelbehälter
Porte gaufres
Dispensador waffles

art. dim. cm.
41472-21 22x26x12



PMMA

Spoon case

Contentitore per palette
Eislöffelbehälter
Porte cuillères à glace
Dispensador cucharillas de helado

art. dim. cm.
41472-20 19x12,5x14



PMMA

Straws case

Contentitore per cannucce
Strohalmbehälter
Porte chalumeaux
Dispensador pajitas

art. dim. cm.
41472-22 26x17x22



PMMA

Cone holder, front opening

Porta coni, apertura frontale
Eiswaffelbehälter mit Frontöffnung
Porte cornets à glace, ouverture frontale
Porta cucuruchos, abertura frontal

art. dim. cm.
41472-16 11x13x50



PMMA

Spoon and cup holder

Porta palette e coppette
Eislöffel und Schalenbehälter
Porte cuillères et pots
Porta cucharillas y copas

art. dim. cm.
41472-17 28x25x55



PMMA

Cone holder 6 holes with spoon drawer

Porta coni 6 fori c/porta palette
Eiswaffelspender, 6 Löcher mit Palettenhalter
Porte cornets 6 trous, porte cuillères
Porta cucuruchos/cucharillas, 6 orificios

art. dim. cm.
41472-18 25,5x18x60,5

Upper hole Ø 3,5 cm. Lower Ø 2 cm. Distance between holes Ø 4,5 cm. Removable lower drawer. – Foro superiore Ø 3,5 cm. Inferiore Ø 2 cm. Distanza tra i fori Ø 4,5 cm. Cassetto inferiore estraibile.



PMMA

Cone holder 12 holes

Porta coni 12 fori
Eiswaffelspender, 12 Löcher
Porte cornets 12 trous
Porta cucurucho 12 orificios

art. dim. cm.
41472-24 33x25x50

Upper hole Ø 5,2 cm. Lower Ø 2 cm.
Foro superiore Ø 5,2 cm. Inferiore Ø 2 cm.



PMMA

Swivel cone holder 5 sections

Porta coni rotante 5 sezioni
Eiswaffelspender, drehbar, 5 Fächer
Porte cornets rotatif, 5 comp
Porta cucurucho giratorio 5 secciones

art. Ø cm. h. cm.
41472-23 25 50

Upper hole Ø 3,5 cm. Lower Ø 2 cm. Distance
between holes Ø 4,5 cm. – Foro superiore Ø 3,5
cm. Inferiore Ø 2 cm. Distanza tra i fori Ø 4,5 cm.



PMMA

Cone holder with door

Porta coni con porta
Eiswaffelspender mit Tür
Porte cornets ouverture frontale
Porta cucurucho, abertura frontal

art. dim. cm.
41472-19 33x18x50



PMMA

Horizontal cone holder with door

Porta coni orizzontale con porta
Eiswaffelspender horizontal mit Tür
Porte cornets à glace horizontal
Porta cucurucho horizontal

art. Ø cm. dim. cm.
41472-14 30 42x37x40,5

With removable divider. – Con divisorio estraibile.



PMMA

Revolving cones dispenser

Porta coni girevole
Eiswaffelspender, drehbar
Porte-cornets pivotant
Distributor giratorio de cucurucho

art. Ø cm. h. cm.
41472-15 24 78



MS

Ice cream cup

Coppa gelato
Eisbecher
Coupe à glace
Copa helado

art. h. cm. lt. U. Pack
44942-11 11 0,38 6



MS

Ice cream cup

Coppa gelato
Eisbecher
Coupe à glace
Copa helado

art. h. cm. lt. U. Pack
44942-10 16 0,25 6



SMMA

Ice cream cup

Coppa gelato
Eisbecher
Coupe à glace
Copa helado

art. Ø cm. h. cm. U. Pack
44942-06 10 10 6



SMMA

Ice cream cup

Coppa gelato
Eisbecher
Coupe à glace
Copa helado

art. Ø cm. h. cm. U. Pack
44942-07 9 19 6

NATURAL ELEGANT



A valid alternative to glass. Elegant and unbreakable ideals for HORECA pastry and ice cream sector. Made with high quality material that confers beside resistance also glossiness and perfect transparency. Bisphenol free. Thermal tolerance -18°C +70°C. Dishwasher safe: up to 50 washes. Can be reused several times and once disposed, they are 100% recyclable. Made in Italy.

La valida alternativa al vetro. Eleganti ed infrangibili ideali per il settore HORECA della pasticceria e gelateria. Realizzati con materiale di alta qualità che gli conferisce oltre alla resistenza anche lucidità e trasparenza. Privi di Bisfenolo. Tolleranza termica -18°C +70°C. Lavabili in lavastoviglie: fino a 50 lavaggi. Possono essere riutilizzati più volte e, una volta gettati, sono riciclabili al 100%. Prodotti made in Italy.



NEW

Cup
Coppetta
Schale
Coupe
Bol

art.	dim. cm.	h. cm.	ml.
48371-12	13,7x3,7x4,1	4,1	120
48371C12	lid/coperchio	-	-

Pcs/Conf. 100 pz.



Bowl
Coppetta
Schale
Coupe
Copa

art.	Ø cm.	h. cm.	ml.
48367-10	7	5,9	105

Pcs/Conf. 100 pz.



Glass
Bicchierino
Glas
Verrine
Vaso

art.	Ø cm.	h. cm.	ml.
48354-01	4	8,5	80

Pcs/Conf. 100 pz.



Glass
Bicchierino
Glas
Verrine
Vaso

art.	dim. cm.	h. cm.	ml.
48371-10	7,3x6,4	5,2	100
48371-11	lid/coperchio	-	-

Pcs/Conf. 100 pz.



Glass
Bicchierino
Glas
Verrine
Vaso

art.	Ø cm.	h. cm.	ml.
48353-01	8,5	6,5	120

Pcs/Conf. 100 pz.



Glass

Bicchierino

Glas

Verrine

Vaso

art.	Ø cm.	h. cm.	ml.
48370-10	7,8	5,7	210
48370-11	lid/coperchio	-	-

Pcs/Conf. 100 pz.



Glass

Bicchierino

Glas

Verrine

Vaso

art.	Ø cm.	h. cm.	ml.
48352-01	6,5	5,5	90
48352-02	7,0	6,7	135
48352-03	7,5	7,3	150

Pcs/Conf. 100 pz.



Cup

Coppetta

Schale

Coupelle

Bol

art.	Ø cm.	h. cm.	ml.
48365-09	9	7,5	215

Pcs/Conf. 100 pz.





Cup

Coppetta
Schale
Coupelle
Bol

art.	Ø cm.	h. cm.	ml.
48366-09	9	7,5	165

Pcs/Conf. 100 pz.



Glass

Bicchierino
Glas
Verrine
Vaso

art.	Ø cm.	h. cm.	ml.
48350-01	4,2	6,5	65
48350-02	5,0	6,5	90
48350-03	5,5	7,0	120
48350-04	6,0	9,0	170

Pcs/Conf. 100 pz.



Glass

Bicchierino
Glas
Verrine
Vaso

art.	dim. cm.	h. cm.	ml.
48351-01	4x4	5,5	60
48351-02	5x5	7,0	120
48351-03	5,7x5,7	7,3	175

Pcs/Conf. 100 pz.



Ice tube mold

Stampo gelato
Eisform
Moule à glace
Molde helados

art.	ml.
41472-36	150

Pcs/Conf. 100 pz.



Ice cream counter display

Espositore per vetrina gelato
Ständer für Eiscremetheke
Présentoir de comptoir
Expositor helados

art.	dim. cm.	holes/fori
41472-34	25x36x4,5	21
41472-35	16x36x4,5	15

For mold/Per stampo: 41472-36.



Holder for blast chiller

Supporto per abbattitore
Ständer für Schnellabkühler
Présentoir à cellule de refroidissement
Soporte para abatidor

art.	dim. cm.	holes/fori
41472-33	29x39x12	28

For mold/Per stampo: 41472-36.



Mini push up pops

Stampi mini push up pops
Mini push up pops Eisformen
Moules à mini push up pops
Mini push up pops moldes

art.	Ø cm.	h. cm.	ml.
41472-37	4,0	18,8	90
41472-38	3,5	19,6	50

Pcs/Conf. 100 pz.



PMMA

Display for mini ice cream cones

Espositore per mini cornetti
Waffelhörnchen-Ständer
Présentoir à mini cornet à glace
Expositor mini conos helado

art.	Ø cm.	dim. cm.	holes/fori
41472-41	1,8	36x16,5	27
41472-42	1,8	36x25	45

Suitable for all waffle minicones on the market.
Per tutti i miniconi in cialda in commercio.



Ice cream mold, silicone

Stampo gelato su stecco, silicone
Eisform, Silikon
Moule à glace, silicone
Molde helado, silicona

art.	mm.	ml.	pcs/pz
41472-47	44x22x93	78	12

Kit 2 molds of 6 pcs with white plastic tray and 50 pcs wooden sticks. – Kit 2 stampi da 6 pz con vassoio in plastica e 50 bastoncini legno.



PMMA

Ice cream counter display

Espositore per vetrina gelato
Ständer für Eiscremetheke
Présentoir de comptoir
Expositor helados

art.	dim. cm.	pcs/pz
41472-48	36x25x5	24

For mold/Per stampo: 41472-47.



Tray with cover

Vassoio con coperchio
Tablett mit Deckel
Plateau avec couvercle
Bandeja con tapa Cm 59X39X8

art.	dim. cm.
41472-50	59x39x8

Unbreakable, shock resistant even at very low temperatures. – Infrangibile, resistente agli urti anche a bassissime temperature.



ABS

Tempering unit

Temperatrice
Temperiergerät
Tempereuse
Templadora

art.	Ø cm.	h. cm.	lt.
47698-01	20,5	21,2	1,7

Ideal for chocolate coatings of ice creams on sticks. Removable anodized aluminum tank.
Ideale per coperture in cioccolato di gelati e semifreddi su stecco. Vasca estraibile in alluminio anodizzato.



ABS

Tempering unit

Temperatrice
Temperiergerät
Tempereuse
Templadora

art.	Ø cm.	h. cm.	lt.
47698-02	26	16	1,8

Allows to process tiny chocolate quantities without any waste. Removable tank.
Adatto per piccole produzioni senza sprechi. Pratica vasca estraibile.



Professional cream whipper

Sifone panna professionale
Profí-Sahnebereiter
Siphon à crème professionnel
Sifón montador de nata profesional

art.	lt.
41451-05	0,5
41451-10	1,0



Cream chargers, 10-pcs set

Ricariche panna montata, conf. 10 pezzi
10-Stk. Sahnekapseln-Packung
Capsules à crème Chantilly, set 10 pièces
Cápsulas para nata, 10 piezas

art.
41450-AA

Contains N2O under pressure.

Contiene N2O sotto pressione.



GOURMET-Cream whipper

Sifone panna
Sahnebereiter
Siphon à crème
Sifón para nata montada

art.	lt.
41458-02	0,25
41458-05	0,50
41458-10	1,00



Heat resistant silicone gasket. Keep warm in bain marie up to 75°C. – Guarnizione in silicone resistente al calore. Tenere a bagnomaria max. a 75°C.



THERMO-Cream whipper

Sifone termico
Thermo-Sahnebereiter
Siphon à crème, isotherme
Sifón isotérmico

art.	lt.
41455T55	0,5

Double-walled, insulated bottle: keeps creations cold for 8 hours and hot for 3 hours, dishwasher-safe. – Bottiglia termica, mantiene le preparazioni in caldo fino a 3 ore e a freddo fino a 8 ore.



THERMO SPRESS-Cream whipper

Sifone termico
Thermo-Sahnebereiter
Siphon à crème, isotherme
Sifón isotérmico

art.	h. cm.	lt.
41459-10	35	1

Double-walled, insulated bottle, keeps creations cold for 8 hours and hot for 3 hours. – Bottiglia termica, mantiene le preparazioni in caldo fino a 3 ore e a freddo fino a 8 ore, lavabile in lavastoviglie.



PROFI-Cream whipper

Sifone panna
Sahnebereiter
Siphon à crème
Sifón para nata montada

art.	lt.
41460-05	0,5
41460-10	1,0

Only for cold preparations. Solo per preparazioni fredde.



Decorating tips, 3-pcs set

Bocchette, set 3 pezzi
Dekorationstüllen, 3er Set
Douilles de décoration, 3 pièces
Boquillas de decoración, 3 piezas

art.
41455-BC



Decorating tips, 3-pcs set

Bocchette, set 3 pezzi
Dekorationstüllen, 3er Set
Douilles de décoration, 3 pièces
Boquillas de decoración, 3 piezas

art.
41458-23



Decorating tips and adapter

Bocchette decoro e adattatore
Dekorationstüllen-Set u. Adapter
Douilles de décoration et adaptateur
Boquillas de decoración y adaptador

art.
41458-24



SS

Injector needles

Iniettori/siringhe decoro
Nadeltüllen
Aiguilles d'injection
Boquillas de aguja

art.

41458-21



Heat protector, silicone

Protezione in silicone
Silikonhülle
Housse en silicone
Protección de silicona

art.

lt.

41458-50 0,5

41458-51 1,0



Cream chargers, PROFESSIONAL

Ricariche panna montata, PROFESSIONAL
Sahnekapseln-Packung, PROFESSIONAL
Capsules à crème Chantilly, PROFESSIONAL
Cápsulas para nata, PROFESSIONAL

art.

pcs/pz

41455-CA 24

41455-CB 50

Filled with 8,4 g of N2O (E942, nitrous oxide).
Contenuto: 8,4 g di N2O (E942 protossido di azoto).



SS

Funnel and sieve

Imbuto e colino
Trichter und Sieb
Entonnoir et tamis
Embudo y tamiz

art.

41458-11



Kit rapid infusion

Kit di infusione rapida
Rapid Infusion Set
Paquet rapid infusion
Rapid infusion set

art.

41458-25

Enables a liquid to be infused with different flavors in the shortest possible time. First, combine aromatic solids (e.g. herbs, spices, fruit) and a liquid (e.g. alcohol, oil, water, vinegar) in the whipper then apply pressure into it using a cream charger. – Permette di infondere un liquido con sapori diversi in tempo rapido. Unire gli aromi solidi (erbe, spezie, frutta, ecc.) con il liquido (alcohol, olio, acqua, aceto, ecc.) nel sifone ed immettere una carica per panna.



COCKTAIL BAR

BAR HAPPY HOUR



Paderno offers a wide selection of bar equipment, designed to combine easy use with efficiency and style. The tools are flanked by fascinating accessories making every moment trendy and lively. To share refined happy hours, to enjoy spectacular cocktails and long drinks, or to add style to every sort of drink.

Paderno propone un'ampia selezione di attrezzature bar, ideata per unire praticità d'utilizzo a efficienza e stile. Agli utensili si affiancano affascinanti accessori in grado di rendere trendy e vivace ogni momento. Per condividere raffinati happy hour, per gustare scenografici cocktail e long drink, oppure per aggiungere stile a ogni tipo di bevanda.



SS

Pumpkin mug, antique

Coppa zucca, antique
Kürbis-Becher, Antique
Gobelet citrouille, antique
Vaso de calabaza, antique

art.	Ø cm.	h. cm.	ml.
44944A07	10	14,5	700



SS

Champagne glass, antique

Flute champagne, antique
Champagner Glas, Antique
Verre champagne, antique
Copa champán, antique

art.	Ø cm.	h. cm.	ml.
41493A00	5	25,5	270



SS

Martini cup, antique

Coppa martini, antique
Martini Cocktail Glas, Antique
Verre à martini, antique
Copa martini, antique

art.	Ø cm.	h. cm.	ml.
41494A00	12	16,5	200



SS

Margarita cup, antique

Coppa margarita, antique
Margarita Cocktail Glas, Antique
Verre à margarita, antique
Copa margarita, antique

art.	Ø cm.	h. cm.	ml.
41498A00	10,5	14	220



SS

Cola cup, antique

Tazza Cola, antique
Cola-Becher, Antique
Gobelet Cola, antique
Taza Cola, antique

art.	Ø cm.	h. cm.	ml.
44941A05	7,5	11	490



SS

Mint julep cup, antique

Coppa mint julep, antique
Becher für Mint Julep, Antique
Tasse à cocktail mint julep, antique
Vaso para mint julep, antique

art.	Ø cm.	h. cm.	ml.
41497A05	8,5	10,5	380



SS

Pumpkin mug

Coppa zucca
Kürbis-Becher
Gobelet citrouille
Vaso de calabaza

art.	Ø cm.	h. cm.	ml.
44944G07	10	14,5	700



SS

Pumpkin mug

Coppa zucca
Kürbis-Becher
Gobelet citrouille
Vaso de calabaza

art.	Ø cm.	h. cm.	ml.
44944C07	10	14,5	700



SS

Pineapple cup
Coppa ananas
Ananas-Becher
Gobelet ananas
Vaso de piña

art.	Ø cm.	h. cm.	ml.	col.
44945G05	9,5	20,5	500	●
44945C05	9,5	20,5	500	●

With straw. – Con cannuccia.



SS

Champagne glass
Flute champagne
Champagner Glas
Verre champagne
Copa champán

art.	Ø cm.	h. cm.	ml.	col.
41493G00	5	25,5	270	●
41493C00	5	25,5	270	●
41493B00	5	25,5	270	●



SS

Wine glass
Coppa vino
Wein Glas
Verre à vin
Copa vino

art.	Ø cm.	h. cm.	ml.	col.
41499G00	9,4	20,8	500	●
41499C00	9,4	20,8	500	●
41499B00	9,4	20,8	500	●



SS

Martini cup
Coppa martini
Martini Cocktail Glas
Verre à martini
Copa martini

art.	Ø cm.	h. cm.	ml.	col.
41494G00	12	16,5	200	●
41494C00	12	16,5	200	●
41494B00	12	16,5	200	●



SS

Margarita cup
Coppa margarita
Margarita Cocktail Glas
Verre à margarita
Copa margarita

art.	Ø cm.	h. cm.	ml.	col.
41498G00	10,5	14	220	●
41498C00	10,5	14	220	●
41498B00	10,5	14	220	●



SS

Moscow mule mug
Tazza moscow mule
Moscow Mule Becher
Gobelet moscow mule
Taza moscow mule

art.	Ø cm.	h. cm.	ml.	col.
41463-01	8,9	9	500	●



SS

Moscow mule mug
Tazza moscow mule
Moscow Mule Becher
Gobelet moscow mule
Taza moscow mule

art.	Ø cm.	h. cm.	ml.	col.
41463-02	8,5	9,7	500	●

Gold plated handle. – Manico dorato.



SS

Moscow mule mug, antique
Tazza moscow mule, antique
Moscow Mule Becher, Antik
Gobelet moscow mule, antique
Taza moscow mule, antiguo

art.	Ø cm.	h. cm.	ml.	col.
41463A05	8,5	9,7	500	●

Gold plated handle. – Manico dorato.



SS

Moscow mule mug
Tazza moscow mule
Moscow Mule Becher
Gobelet moscow mule
Taza moscow mule

art.	Ø cm.	h. cm.	ml.	col.
41463G05	8,5	9,7	500	●

Gold plated handle. – Manico dorato.



SS

Moscow mule mug
Tazza moscow mule
Moscow Mule Becher
Gobelet moscow mule
Taza moscow mule

art.	Ø cm.	h. cm.	ml.	col.
41463B05	8,5	9,7	500	●

Gold plated handle. – Manico dorato.



SS

Moscow mule mug
Tazza moscow mule
Moscow Mule Becher
Gobelet moscow mule
Taza moscow mule

art.	Ø cm.	h. cm.	ml.
41463M05	8,5	10	550

Water transfer printing. Gold plated handle.
Stampa a trasferimento ad acqua. Manico dorato.





SS

Moscow mule mug
Tazza moscow mule
Becher Moscow Mule
Gobelet moscow mule
Taza moscow mule

art.	Ø cm.	h. cm.	lt.	col.
41463C30	15,5	17,5	3	●
41463C50	18,0	20,0	5	●

Gold plated handle. – Manico dorato.



SS

Moscow mule mug, antique
Tazza moscow mule, antique
Becher Moscow Mule, Antik
Gobelet moscow mule, antique
Taza moscow mule, antiguo

art.	Ø cm.	h. cm.	lt.	col.
41463A30	15,5	17,5	3	●
41463A50	18,0	20,0	5	●

Gold plated handle. – Manico dorato.



SS

Mini moscow mule mug
Mini moscow mule
Moscow Mule Shotbecher
Moscow mule à shot
Chupito moscow mule

art.	Ø cm.	h. cm.	ml.	col.
41463C00	4,6	4,7	60	●

Gold plated handle. Set 4 pcs. – Manico dorato. Conf. 4 pz.



SS

Mini moscow mule mug, antique
Mini moscow mule, antique
Moscow Mule Shotbecher, Antik
Moscow mule à shot, antique
Chupito moscow mule, antiguo

art.	Ø cm.	h. cm.	ml.	col.
41463A00	4,6	4,7	60	●

Gold plated handle. Set 4 pcs. – Manico dorato. Conf. 4 pz.



SS

Cola cup

Tazza Cola
Cola-Becher
Gobelet Cola
Taza Cola

art.	Ø cm.	h. cm.	ml.	col.
44941G05	7,5	11	490	●
44941C05	7,5	11	490	●
44941B05	7,5	11	490	●



SS

Mint julep cup

Coppa mint julep
Becher für Mint Julep
Tasse à cocktail mint julep
Vaso para mint julep

art.	Ø cm.	h. cm.	ml.	col.
41497-05	8,5	10,5	380	●
41497G05	8,5	10,5	380	●
41497C05	8,5	10,5	380	●
41497B05	8,5	10,5	380	●



SS

Julep mug

Tazza julep
Becher Julep
Gobelet julep
Taza julep

art.	Ø cm.	h. cm.	ml.	col.
41470C03	8	12	335	●



SS

Julep mug, antique

Tazza julep, antique
Becher Julep, Antik
Gobelet julep, antique
Taza julep, antiguo

art.	Ø cm.	h. cm.	ml.	col.
41470A03	8	12	335	●



SS

Mini mug

Mini tazza
Shotbecher
Verre à shot
Vaso de chupito

art.	Ø cm.	h. cm.	ml.	col.
41470C00	4,5	5,5	60	●

Set 4 pcs. – Conf. 4 pz.



SS

Mini mug, antique

Mini tazza, antique
Shotbecher, Antik
Verre à shot, antique
Vaso de chupito, antiguo

art.	Ø cm.	h. cm.	ml.	col.
41470A00	4,5	5,5	60	●

Set 4 pcs. – Conf. 4 pz.





Tiki skull glass

Tiki mug teschio in vetro
Tiki-Schädelglas
Tiki mug crâne en verre
Vaso Tiki de vidro

art.	Ø cm.	h. cm.	ml.
44948-07	13	10,5	700



Tiki mug ceramic

Tiki mug in ceramica
Tiki-Becher aus Keramik
Tiki mug en céramique
Taza Tiki en cerámica

art.	h. cm.	ml.
44949-02	22	500



Tiki mug ceramic

Tiki mug in ceramica
Tiki-Becher aus Keramik
Tiki mug en céramique
Taza Tiki en cerámica

art.	Ø cm.	h. cm.	ml.
44949-01	9,3	11	450



Tiki mug ceramic

Tiki mug in ceramica
Tiki-Becher aus Keramik
Tiki mug en céramique
Taza Tiki en cerámica

art.	Ø cm.	h. cm.	ml.
44949-03	7	21,5	650



Tiki mug ceramic

Tiki mug in ceramica
Tiki-Becher aus Keramik
Tiki mug en céramique
Taza Tiki en cerámica

art.	h. cm.	ml.
44949-04	15	550



Tiki mug ceramic

Tiki mug in ceramica
Tiki-Becher aus Keramik
Tiki mug en céramique
Taza Tiki en cerámica

art.	Ø cm.	h. cm.	ml.
44949-05	8	16,5	340



Tiki mug ceramic

Tiki mug in ceramica
Tiki-Becher aus Keramik
Tiki mug en céramique
Taza Tiki en cerámica

art.	Ø cm.	h. cm.	ml.
44949-06	8	17	510



Tiki mug ceramic

Tiki mug in ceramica
Tiki-Becher aus Keramik
Tiki mug en céramique
Taza Tiki en cerámica

art.	Ø cm.	h. cm.	ml.
44949-07	6,2	10	700



Tiki mug ceramic

Tiki mug in ceramica
Tiki-Becher aus Keramik
Tiki mug en céramique
Taza Tiki en cerámica

art.	Ø cm.	h. cm.	ml.
44949-08	10	13	600



Tiki mug ceramic

Tiki mug in ceramica
Tiki-Becher aus Keramik
Tiki mug en céramique
Taza Tiki en cerámica

art.	Ø cm.	h. cm.	ml.
44949-09	8,8	12,5	560



Tiki mug ceramic

Tiki mug in ceramica
Tiki-Becher aus Keramik
Tiki mug en céramique
Taza Tiki en cerámica

art.	Ø cm.	h. cm.	ml.
44949-10	7	17,3	430



PVD
SS

Straight straws

Cannucce
Strohhalme
Pailles
Pajitas

art.	Ø mm.	l. cm.	col.
41490-00	6	21,5	●
41490B00	6	21,5	●
41490G00	6	21,5	●
41490C00	6	21,5	●

Set 12 pcs plus 1 straw brush.
Conf. 12 pz + 1 scovolino.



PVD
SS

Curved straws

Cannucce curve
Gebogene Strohhalme
Pailles incurvées
Pajitas curvados

art.	Ø mm.	l. cm.	col.
41490-01	6	21,5	●
41490B01	6	21,5	●
41490G01	6	21,5	●
41490C01	6	21,5	●

Set 12 pcs plus 1 straw brush.
Conf. 12 pz + 1 scovolino.



SS

Straw brush, 5 pcs

Scovolini, 5 pezzi
Strohhalme-Bürste, 5 Stk.
Brosses à pailles, 5 pièces
Cepillos para pajitas, 5 pz

art.	l. cm.
41490-AA	21



B

Straight straws, 24 pcs

Cannucce, 24 pz
Strohhalme, 24 Stk
Pailles, 24 pièces
Pajitas, 24 piezas

art.	Ø mm.	l.
48310-14	5-7	140
48310-20	5-7	200



B

Straight straws, 150 pcs

Cannucce, 150 pz
Strohhalme, 150 Stk
Pailles, 150 pièces
Pajitas, 150 piezas

art.	Ø mm.	l.
48311-20	6-8	200
48311-25	6-8	250



B

Straight straws, 110 pcs

Cannucce, 110 pz
Strohhalme, 110 Stk
Pailles, 110 pièces
Pajitas, 110 piezas

art.	Ø mm.	l.
48312-25	9-10	250



B

Straight straws, 24 pcs

Cannuce, 24 pz
Strohhalme, 24 Stk
Pailles, 24 pièces
Pajitas, 24 piezas

art.	Ø mm.	l.
48313-14	10-12	140
48313-18	10-12	180



3 Straight straws, 3 bent, glass

3 Cannuce diritte, 3 curve in vetro
3 Gerade Strohhalme, 3 gebogene aus Glas
3 Pailles droites, 3 incurvées en verre
3 Pajitas eectas, 3 curvados de vidrio

art.	Ø mm.	l.
41495-08	8	215
41495-10	10	215

Incl. 2 straw brushes. – Incl. 2 scovolini.



SS

Drinks stirrers flamingo, 4 pcs

Miscelatori cocktail fenicottero, 4 pz
Flamingo-Cocktail Rührer, 4 Stk
Agitateurs cocktails flamant, 4 pcs
Agitadores cócteles flamingo, 4 pz

art.	l. cm.	col.
41491G00	21,5	●
41491C00	21,5	●



SS

Drinks stirrers skull, 4 pcs

Miscelatori cocktail teschio, 4 pz
Totenkopf-Cocktail Rührer, 4 Stk
Agitateurs tête de mort, 4 pcs
Agitadores cócteles cráneo, 4 pz

art.	l. cm.	col.
41491G01	18,5	●
41491C01	18,5	●



SS

Drinks stirrers pineapple, 4 pcs

Miscelatori cocktail ananas, 4 pz
Ananas-Cocktail Rührer, 4 Stk
Agitateurs cocktails ananas, 4 pcs
Agitadores cócteles piña, 4 pz

art.	l. cm.	col.
41491G02	20	●
41491C02	20	●



SS

Drinks stirrers owl, 4 pcs

Miscelatori cocktail gufo, 4 pz
Eule-Cocktail Rührer, 4 Stk
Agitateurs cocktails hibou, 4 pcs
Agitadores cócteles búho, 4 pz

art.	l. cm.	col.
41491G03	20	●
41491C03	20	●



SS

Drinks stirrers seahorse, 4 pcs

Miscelatori cavalluccio marino, 4 pz
Seepferdchen-Cocktail Rührer, 4 Stk
Agitateurs hippocampe, 4 pcs
Agitadores caballo de mar, 4 pz

art.	l. cm.	col.
41491G04	20,5	●
41491C04	20,5	●



SS

Drinks stirrers bow-knot, 4 pcs

Miscelatori cocktail fiocco, 4 pz
Bogenknoten-Cocktail Rührer, 4 Stk
Agitateurs noeud d'arc, 4 pcs
Agitadores nudo de proa, 4 pz

art.	l. cm.	col.
41491G05	21	●
41491C05	21	●



SS

Drinks stirrers octopus, 4 pcs

Miscelatori cocktail polipo, 4 pz
Tintenfisch-Cocktail Rührer, 4 Stk
Agitateurs cocktails poulpe, 4 pcs
Agitadores cócteles pulpo, 4 pz

art.	l. cm.	col.
41491G06	18,5	●
41491C06	18,5	●



SS

Tweezer

Pinza
Zange
Pince
Pinza

art.	l. cm.	col.
42902-30	30	●
42902G30	30	●



SS

Tweezer

Pinza
Zange
Pince
Pinza

art.	l. cm.	col.
42902C30	30	●
42902B30	30	●



SS

Tweezer

Pinza
Zange
Pince
Pinza

art.	l. cm.
42902-31	30



SS

Cocktail spoon

Cucchiaio miscelatore
Cocktail-Löffel
Cuillère à cocktail
Cuchara cóctel

art.	l. cm.
41605-00	27



SS

Cocktail spoon

Cucchiaio miscelatore
Cocktail-Löffel
Cuillère à cocktail
Cuchara cóctel

art.	l. cm.	col.
41605-01	27	●



SS

Cocktail spoon

Cucchiaio miscelatore
Cocktail-Löffel
Cuillère à cocktail
Cuchara cóctel

art.	l. cm.	col.
41605G27	27	●
41605B27	27	●



SS

Cocktail spoon, antique

Cucchiaio miscelatore, antique
Cocktail-Löffel, Antique
Cuillère à cocktail, antique
Cuchara cóctel, antique

art.	l. cm.
41605A27	27

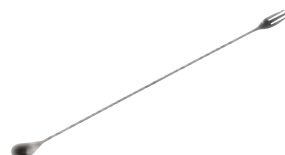

SS

Cocktail spoon/fork, antique

Cucchiaio/forchetta miscelatore, antique
Cocktail-Löffell/-Gabel, Antique
Cuillère/fourchette à cocktail, antique
Cuchara/tenedor cóctel, antique

art.	l. cm.
41605A30	30
41605A03	50



SS

Cocktail spoon/fork

Cucchiaio/forchetta miscelatore
Cocktail-Löffell/-Gabel
Cuillère/fourchette à cocktail
Cuchara/tenedor cóctel

art.	l. cm.	col.
41605-30	30	●
41605G30	30	●



SS

Cocktail spoon/fork

Cucchiaio/forchetta miscelatore
Cocktail-Löffell/-Gabel
Cuillère/fourchette à cocktail
Cuchara/tenedor cóctel

art.	l. cm.	col.
41605C30	30	●
41605B30	30	●



SS

Cocktail spoon/fork

Cucchiaio/forchetta miscelatore
Cocktail-Löffell/-Gabel
Cuillère/fourchette à cocktail
Cuchara/tenedor cóctel

art.	l. cm.	col.
41605-03	50	●
41605G03	50	●





SS

Cocktail spoon/fork

Cucchiaio/forchetta miscelatore
Cocktail-Löffell/-Gabel
Cuillère/fourchette à cocktail
Cuchara/tenedor cóctel

art.	l. cm.	col.
41605C03	50	●
41605B03	50	●



SS

Absinthe spoon

Cucchiaio assenzio
Absinth-Löffel
Cuillère d'absinthe
Cuchara de ajeno

art.	l. cm.	col.
41600-00	16	●
41600G00	16	●
41600C00	16	●



SS

Magic spoon whisks

Cucchiaio magico
Zauberlöffel
Fouet plat à spirales
Cuchara mágica

art.	l. cm.
41595-20	20



SS

Strainer, antique

Colino, antique
Sieb, Antique
Passoire, antique
Colador, antique

art.	Ø cm.
41570A10	8



SS

Strainer

Colino
Sieb
Passoire
Colador

art.	Ø cm.	col.
41570-10	8	●
41570G10	8	●



SS

Strainer

Colino
Sieb
Passoire
Colador

art.	Ø cm.	col.
41570C10	8	●
41570B10	8	●



SS

Cocktail strainer, antique
Colino cocktail, antique
Cocktail-Sieb, Antique
Passoire à cocktail, antique
Colador de cóctel, antique

art.	Ø cm.
41603A00	9



SS

Cocktail strainer
Colino cocktail
Cocktail-Sieb
Passoire à cocktail
Colador de cóctel

art.	Ø cm.	col.
41603-00	9	●
41603G00	9	●



SS

Cocktail strainer
Colino cocktail
Cocktail-Sieb
Passoire à cocktail
Colador de cóctel

art.	Ø cm.	col.
41603C00	9	●
41603B00	9	●



SS

Julep strainer, antique
Colino Julep, antique
Julep Barsieb, Antique
Tamis cocktail Julep, antique
Colador de cóctel

art.	Ø cm.
41603A07	7



SS

Julep strainer
Colino Julep
Julep Barsieb
Tamis cocktail Julep
Colador de cóctel

art.	Ø cm.	col.
41603-07	7	●
41603G07	7	●



SS

Julep strainer
Colino Julep
Julep Barsieb
Tamis cocktail Julep
Colador de cóctel

art.	Ø cm.	col.
41603C07	7	●
41603B07	7	●



SS

Cocktail measuring cup
Misurino cocktail
Alkohol-Meßbecher
Mesureur de cocktail
Medidor de cóctel

art.	ml.
41609-75	75



SS

Cocktail jigger, antique
Misurino cocktail, antique
Cocktail-Doppelmaß, Antique
Mesureur de cocktail, antique
Medidor de cóctel, antique

art.	ml.
41609A36	30/60



SS

Cocktail jigger, antique
Misurino cocktail, antique
Cocktail-Doppelmaß, Antique
Mesureur de cocktail, antique
Medidor de cóctel, antique

art.	ml.
41604A00	20/40



SS

Japanese jigger, antique
Misurino cocktail Giappone, antique
Japanischer Messbecher, Antique
Mesureur de cocktail Japonais, antique
Medidor de cóctel Japonés, antique

art.	ml.
41604A01	20/40



SS

Cocktail jigger
Misurino cocktail
Cocktail-Doppelmaß
Mesureur de cocktail
Medidor de cóctel

art.	ml.	col.
41609-36	30/60	●
41609G36	30/60	●
41609C36	30/60	●
41609B36	30/60	●



SS

Cocktail jigger
Misurino cocktail
Cocktail-Doppelmaß
Mesureur de cocktail
Medidor de cóctel

art.	ml.	col.
41604-00	20/40	●
41604G00	20/40	●
41604C00	20/40	●
41604B00	20/40	●





SS

Japanese jigger

Misurino cocktail Giappone
Japanischer Messbecher
Mesureur de cocktail Japonais
Medidor de cóctel Japonés

art.	ml.	col.
41604-01	20/40	●
41604G01	20/40	●
41604C01	20/40	●
41604B01	20/40	●



SS

Long-drink shaker, antique

Shaker, antique
Shaker, Antique
Shaker, antique
Coctelera, antique

art.	Ø cm.	h. cm.	ml.
41484A05	8,8	20,5	500



SS

Long-drink shaker, antique

Shaker, antique
Shaker, Antique
Shaker, antique
Coctelera, antique

art.	ml.
41480A05	500



SS

Shaker parisienne, antique

Shaker parisienne, antique
Shaker parisienne, Antique
Shaker parisienne, antique
Coctelera parisienne, antique

art.	Ø cm.	h. cm.	ml.
41461A07	9	23	700



SS

Shaker calabrese, antique

Shaker calabrese, antique
Shaker calabrese, Antique
Shaker calabrese, antique
Coctelera calabrese, antique

art.	Ø cm.	h. cm.	ml.
41464A09	9,5	24,5	900



SS

Boston tin + half tin, antique

Shaker boston 2 pz, antique
Boston Shaker, 2 Stk, Antique
Shaker boston, 2 pcs, antique
Coctelera boston, 2 pz, antique

art.	Ø cm.	ml.
41467A08	9	790/590



SS

Long-drink shaker

Shaker
Shaker
Shaker
Coctelera

art.	Ø cm.	h. cm.	ml.	col.
41484-05	8,8	20,5	500	●
41484G05	8,8	20,5	500	●
41484C05	8,8	20,5	500	●
41484B05	8,8	20,5	500	●



SS

Long-drink shaker

Shaker
Shaker
Shaker
Coctelera

art.	Ø cm.	h. cm.	ml.	col.
41480G05	8,7	20,5	500	●
41480C05	8,7	20,5	500	●
41480B05	8,7	20,5	500	●



SS

Shaker parisienne

Shaker parisienne
Shaker parisienne
Shaker parisienne
Coctelera parisienne

art.	Ø cm.	h. cm.	ml.	col.
41461-07	9	23	700	●
41461G07	9	23	700	●
41461C07	9	23	700	●
41461B07	9	23	700	●



SS

Shaker calabrese

Shaker calabrese
Shaker Calabrese
Shaker calabrese
Coctelera calabrese

art.	Ø cm.	h. cm.	ml.	col.
41464-09	9,5	24,5	900	●
41464G09	9,5	24,5	900	●
41464C09	9,5	24,5	900	●
41464B09	9,5	24,5	900	●



SS

Boston tin + half tin

Shaker boston 2 pz
Boston Shaker, 2 Stk
Shaker boston, 2 pcs
Coctelera boston, 2 pz

art.	Ø cm.	ml.	col.
41467G08	9	790/590	●
41467C08	9	790/590	●
41467B08	9	790/590	●



SS

Long-drink shaker

Shaker
Shaker
Shaker
Coctelera

art.	ml.
41480-03	200
41480-05	500
41480-07	700





SS

SAN

Long-drink shaker

Shaker
Shaker
Shaker
Coctelera

art.	ml.	col.
41481-02	550	●
41481-03	550	●



PS

Long-drink shaker

Shaker
Shaker
Shaker
Coctelera

art.	h. cm.	ml.
41483-04	22,5	450



SS

Boston shaker, vinyl coated

Cono boston, rivestimento vinile
Boston-Shaker, Vinyl Überzug
Shaker boston, revêtement en vinyle
Coctelera boston, revestimiento vinilo

art.	Ø cm.	h. cm.	ml.	col.
41479-11	9	18	830	●



SS

Boston shaker

Cono boston con fondello
Boston-Shaker
Shaker boston
Coctelera boston

art.	Ø cm.	h. cm.	ml.
41479-05	9	17	500



Mixing glass

Bicchiere miscelatore
Rührglas
Verre mélangeur
Vaso mezclador

art.	Ø cm.	h. cm.	ml.
41479-AA	8,5	15	500



Mixing glass

Bicchiere miscelatore
Rührglas
Verre mélangeur
Vaso mezclador

art.	Ø cm.	h. cm.	ml.
41478-50	8,8	15	473
41478-35	8,3	13	355



Mixing glass

Bicchiere miscelatore
Rührglas
Verre mélangeur
Vaso mezclador

art.	Ø cm.	h. cm.	ml.
41477-50	9	15	473

With ounce markings. – Graduato in once.



Mixing glass with lip

Bicchiere miscelatore con becco versatore
Rührglas mit Lippe
Verre mélangeur avec bec verseur
Vaso mezclador vertedor con pico

art.	Ø cm.	h. cm.	lt.
41514-05	9	16,5	0,5



Mixing glass with lip

Bicchiere miscelatore con becco versatore
Rührglas mit Lippe
Verre mélangeur avec bec verseur
Vaso mezclador vertedor con pico

art.	Ø cm.	h. cm.	lt.
41514-10	11,5	19	0,95



PC

Whiskey glass

Bicchiere whiskey
Whiskey Glas
Verre à whiskey
Vaso whiskey

art.	Ø cm.	h. cm.	ml.
44940-01	8,5	9,5	420

U.Pack 6 pcs



PC

Juice glass

Bicchiere succo
Fruchtsaft-Glas
Verre à jus
Vaso zumo

art.	Ø cm.	h. cm.	ml.
44940-02	7,5	15,5	460

U.Pack 6 pcs



PC

Beer glass

Boccale birra
Bier-Glas
Verre à bière
Vaso cerveza

art.	Ø cm.	h. cm.	ml.
44940-06	8	23	450

U.Pack 6 pcs



SMMA

Beer glass
Boccale birra
Bier-Glas
Verre à bière
Vaso cerveza

art.	Ø cm.	h. cm.	ml.
44940-08	9	16	500

U.Pack 6 pcs



PC

Margarita glass
Bicchiere margarita
Margarita-Glas
Verre à margarita
Vaso margarita

art.	Ø cm.	h. cm.	ml.
44940-10	12	18	300

U.Pack 6 pcs



PC

Martini glass
Bicchiere martini
Martini-Glas
Verre à martini
Vaso martini

art.	Ø cm.	h. cm.	ml.
44940-11	12	17	240

U.Pack 6 pcs



PC

Wine glass
Bicchiere vino
Wein-Glas
Verre à vin
Vaso vino

art.	Ø cm.	h. cm.	ml.
44940-12	7	21	300

U.Pack 6 pcs



PC

Wine glass
Bicchiere vino
Wein-Glas
Verre à vin
Vaso vino

art.	Ø cm.	h. cm.	ml.
44940-13	7	19	200

U.Pack 6 pcs



PC

Champagne glass
Bicchiere spumante
Sekt-Glas
Flûte
Vaso champaña

art.	Ø cm.	h. cm.	ml.
44940-14	5	22	180

U.Pack 6 pcs



PC

Mixing glass
Bicchiere
Glas
Verre
Vaso

art.	Ø cm.	h. cm.	ml.
44940-16	9	16	540

U.Pack 6 pcs



PC

Whiskey/rocks glass
Bicchiere whiskey/rocks
Whiskey-/Rocks-Glas
Verre à whiskey/rocks
Vaso whiskey/rocks

art.	Ø cm.	h. cm.	ml.
44940-17	9	12	420

U.Pack 6 pcs



PC

Whiskey/rocks glass
Bicchiere whiskey/rocks
Whiskey-/Rocks-Glas
Verre à whiskey/rocks
Vaso whiskey/rocks

art.	Ø cm.	h. cm.	ml.
44940-18	8,5	11,5	420

U.Pack 6 pcs



PC

Cooler
Bicchiere
Glas
Verre
Vaso

art.	Ø cm.	h. cm.	ml.
44940-19	8	17	540

U.Pack 6 pcs



PC

Tumbler
Bicchiere
Trinkbecher
Gobelet
Vaso

art.	Ø cm.	h. cm.	ml.
44940-24	7,5	12,5	360
44940-25	8,0	13,5	480
44940-26	8,5	16,0	660

U.Pack 6 pcs



PC

Tumbler
Bicchiere
Trinkbecher
Gobelet
Vaso

art.	Ø cm.	h. cm.	ml.
44940-32	7,5	12,5	360
44940-33	8,0	13,5	480
44940-34	8,5	16,0	660

U.Pack 6 pcs





SAN

Tumbler
Bicchieri
Trinkbecher
Gobelet

art.	Ø cm.	h. cm.	ml.
44990-15	5,5	9,5	150
44990-24	6,5	10,0	240
44990-29	7,0	11,0	290
44990-36	7,5	13,0	360
44990-48	8,0	15,0	480

U.Pack 6 pcs



Cover with spout
Coperchio con beccuccio
Deckel mit Ausguss
Couvreclre avec bec
Tapa con boquilla

art.	Ø cm.	U. Pack
44871-23	7	10

TPE. For PC glasses 250 ml.
TPE. Per bicchieri in PC da 250 ml.



PC

Water tumbler
Bicchieri acqua
Wasserglas
Verre à eau
Vaso agua

art.	Ø cm.	h. cm.	ml.	U. Pack
44871-20	7,0	7,0	170	50
44871-21	7,0	10,2	250	50
44871-22	7,8	11,4	350	30



PC

Water tumbler
Bicchieri acqua
Wasserglas
Verre à eau
Vaso agua

art.	Ø cm.	h. cm.	ml.	U. Pack	col.
44871R20	7,0	7,0	170	50	●
44871L20	7,0	7,0	170	50	●
44871G20	7,0	7,0	170	50	●
44871B20	7,0	7,0	170	50	●



PC

Water tumbler
Bicchieri acqua
Wasserglas
Verre à eau
Vaso agua

art.	Ø cm.	h. cm.	ml.	U. Pack	col.
44871R21	7,0	10,2	250	50	●
44871L21	7,0	10,2	250	50	●
44871G21	7,0	10,2	250	50	●
44871B21	7,0	10,2	250	50	●



PC

Water jug
Caraffa
Wasserkrug
Crûche à eau
Jarra agua

art.	dim. cm.	l.
44871-28	12x13,8	0,5
44871-30	17,4x17	1,0
44871-32	18,7x19,8	1,5
44871-34	21,6x18,8	2,0

Withstands temperatures/Termoresistenti da:
-30° +120°C.



PP

Lid
Coperchio
Deckel
Couvreclre
Tapa

art.	dim. cm.	fits/per	U. Pack
44871-29	9,9x1,4	l. 0,5	10
44871-31	11,2x1,9	l. 1,0	10
44871-33	14x2,4	l. 1,5	10
44871-35	15,9x2,2	l. 2,0	10

Withstands temperatures/Termoresistenti da:
-40° +100°C.



SMMA

Cocktail glass

Bicchiere cocktail
Cocktail Glas
Verre à cocktail
Vaso cocktail

art.	Ø cm.	h. cm.	ml.
44942-01	8	21	350

U.Pack 6 pcs



SMMA

Cocktail glass

Bicchiere cocktail
Cocktail Glas
Verre à cocktail
Vaso cocktail

art.	Ø cm.	h. cm.	ml.
44942-02	11	21	460

U.Pack 6 pcs



SMMA

Martini glass

Bicchiere martini
Martini-Glas
Verre à martini
Vaso martini

art.	Ø cm.	h. cm.	ml.
44942-03	10,5	20	340

U.Pack 6 pcs



SMMA

Cocktail glass

Bicchiere cocktail
Cocktail Glas
Verre à cocktail
Vaso cocktail

art.	Ø cm.	h. cm.	ml.
44942-04	7,5	23	220

U.Pack 6 pcs



SMMA

Margarita glass

Bicchiere margarita
Margarita-Glas
Verre à margarita
Vaso margarita

art.	Ø cm.	h. cm.	ml.
44942-05	12	17,5	340

U.Pack 6 pcs



SS

Fruit basket

Cesto agrumi
Obstkorb
Panier à fruits
Cesta frutas

art.	Ø cm.	h. cm.
41611-20	21,5	20



SS

Fruit basket, oval

Cesto frutta, ovale
Obstschale, oval
Panier à fruits, ovale
Cesta fruta, oval

art.	dim. cm.
42956-19	19x15
42956-24	24,5x18
42956-28	28x21



NEW

Fruit basket

Cesto frutta
Obstschale
Panier à fruits
Cesta fruta

art.	Ø cm.	h. cm.
42882-23	23	25

Metal frame, black powder coating.
Metallo verniciato a polvere nero.

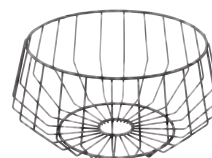

NEW

Fruit basket

Cesto frutta
Obstschale
Panier à fruits
Cesta fruta

art.	Ø cm.	h. cm.
42882-28	28	14

Metal frame, black powder coating.
Metallo verniciato a polvere nero.



Serving stand 2-tier

Alzata 2 piani
Serviergestell, 2-stufig
Présentoir 2 étages
Soporte 2 niveles

art. dim. cm.
41208-06 31x17x38

Black metal frame with non-slip feet, 2 baskets 29x16x7 cm, 2 acacia wood boards 28,5x15,5x1,5 cm. – Struttura in metallo nero con piedini antiscivolo, 2 cesti cm 29x16x7, 2 assi in legno di acacia cm 28,5x15,5x1,5.



Fruit basket 2-tier

Cesto agrumi 2 piani
Obstkorb, 2-stufig
Panier à fruits 2 étages
Cesta frutas 2 niveles

art. Ø cm. h. cm.
41208-02 22/26 48

Wooden handle, metal black baskets Ø 22 H 6 cm and Ø 26 H 8 cm. – Manico legno, cesti in metallo nero Ø 22 H 6 cm e Ø 26 H 8 cm.



Orange juicer, chromed

Spremiagrumi manuale, cromato
Orangenpresse, verchromt
Presse-agrumes, chromé
Exprimidor de cítricos, cromado

art. dim. cm.
41456-02 18x13x46



SS

Lemon squeezer

Spremilimone
Zitronenpresse
Presse citron
Exprime limones

art. dim. cm.
41606-00 12,5x6,5



SS

Lemon squeezer

Spremilimone
Zitronenpresse
Presse citron
Exprime limones

art. dim. cm.
41606-01 7x8,5



Lemon squeezer, aluminum

Spremilimone, alluminio
Zitronenpresse, aluminum
Presse citron, alu
Exprime limones, aluminio

art. l. cm.
41606-02 20



Lemon/lime squeezer, aluminum

Spremilimone/limo, alluminio
Zitronen-/Limettenpresse, aluminum
Presse citron, alu
Exprimidor de limón/lima, aluminio

art. dim. cm.
41606-22 22x7,5

3 pieces, powder coated yellow and green.
3 pezzi, verniciato a polvere giallo e verde.



Soda siphon

Sifone soda
Soda Siphon
Siphon à eau de seltz
Sifón agua de seltz

art. lt.
41453-11 1



Soda siphon

Sifone soda
Soda Siphon
Siphon à eau de seltz
Sifón agua de seltz

art.	lt.
41465-10	1



Soda siphon

Sifone soda
Soda Siphon
Siphon à eau de seltz
Sifón agua de seltz

art.	lt.
41454-01	1



2 Bottles Twist&Sparkle

2 Bottiglie Twist&Sparkle
2 Flaschen Twist&Sparkle
2 Bouteilles Twist&Sparkle
2 Botellas Twist&Sparkle

art.	lt.
41454-99	1



Soda chargers, 10-pcs set

Ricariche soda, 10 pezzi
10-Stk. Sodakapseln-Packung
Capsules à eau de seltz, set 10 pcs
Cápsulas para agua de seltz, 10 pz

art.
41453-AA

Content: 8 g of CO₂. – Contenuto: 8 gr di CO₂.



Ice pick

Rompighiaccio
Eisstößel
Casse-glace
Pico para hielo

art.	l. cm.
44105-00	23

Wooden handle. – Manico legno.



Muddler, plastic

Pestaghiaccio, plastica
Eiszerstosser, Kunststoff
Pic à glace, plastique
Pico para hielo, plástico

art.	l. cm.
41503-22	22,5



SS

Muddler

Pestaghiaccio
Eiszerstosser
Pic à glace
Pico para hielo

art.	l. cm.
41503-21	20



SS

Muddler

Pestaghiaccio
Eiszerstosser
Pic à glace
Pico para hielo

art.	l. cm.	col.
41503G21	20	●
41503C21	20	●



Ice crusher, chromed

Tritaghiaccio, cromato
Eiswolf, verchromt
Broyer à glace, chromé
Trituradora de hielo, cromada

art.	dim. cm.
41457-00	15x12x26



SS

Ice scoop

Sessola per ghiaccio
Eisschaufel
Pelle à glace
Librador para hielo

art.	ml.
41503-00	100



PC

Ice scoop

Sessola per ghiaccio
Eisschaufel
Pelle à glace
Librador para hielo

art.	ml.
14958-01	100
14958-02	250



SS

Ice spoon

Cucchiaio ghiaccio
Eislöffel
Cuillère à glace
Cuchara hielo

art.	l. cm.
12550-04	22



Mold for ice-ball, silicone

Stampo sfera di ghiaccio, silicone
Eis-Kugel-Former, Silikon
Moule à boule de glace, silicone
Molde bola de hielo, silicona

art. dim. cm.
41515-10 6,5x7,5

For 1 ball ø 6 cm. – Per 1 sfera ø 6 cm.



PP

Mold for ice-balls

Stampo sfere di ghiaccio
Eis-Kugel-Former
Moule pour boules de glace
Molde bolas de hielo

art. dim. cm.
41515-03 24x8,5

For 3 balls ø 5,5 cm, 100 ml.
Per 3 sfere ø 5,5 cm da 100 ml.



Mold for ice-balls, silicone

Stampo sfere di ghiaccio, silicone
Eis-Kugel-Former, Silikon
Moule à boules de glace, silicone
Molde bolas de hielo, silicona

art. dim. cm.
41515-08 13,5x13,5x4,5

For 4 balls ø 4,5 cm. – Per 4 sfere ø 4,5 cm.



Mold for ice-balls, silicone

Stampo sfere di ghiaccio, silicone
Eis-Kugel-Former, Silikon
Moule à boules de glace, silicone
Molde bolas de hielo, silicona

art. dim. cm.
41515-09 25x12,5x5

For 8 balls ø 4 cm. – Per 8 sfere ø 4 cm.



Mold for ice-balls, silicone

Stampo sfere di ghiaccio, silicone
Eis-Kugel-Former, Silikon
Moule à boules de glace, silicone
Molde bolas de hielo, silicona

art. dim. cm.
41515-22 24x12x2

For 40 balls ø 1 cm. – Per 40 sfere ø 1 cm.



Mold for ice-skulls, silicone

Stampo teschi ghiaccio, silicone
Eis-Schädel-Former, Silikon
Moule à crânes de glace, silicone
Molde de crâneos de hielo, silicona

art. dim. cm.
41515-05 11,5x7,5x4,3



Mold for ice-diamonds, silicone

Stampo diamanti ghiaccio, silicone
Eis-Diamant-Former, Silikon
Moule à diamants de glace, silicone
Molde de diamante de hielo, silicona

art. dim. cm.
41515-07 12x12x3,8



NEW

Mold for ice-roses, silicone

Stampo rose ghiaccio, silicone
Eis-Rosen-Former, Silikon
Moule à roses de glace, silicone
Molde de rosas de hielo, silicona

art. dim. cm.
41515-06 16,8x16,8x6



NEW

Mold for ice-cubes, silicone

Stampo cubi ghiaccio, silicone
Eiswürfel-Former, Silikon
Moule à glaçons, silicone
Molde cubos de hielo, silicona

art. dim. cm.
41515-19 16,7x16,7x5

For 6 cubes 4,7 cm. – Per 6 cubi 4,7 cm.



NEW

Mold for ice-cubes, silicone

Stampo cubi ghiaccio, silicone
Eiswürfel-Former, Silikon
Moule à glaçons, silicone
Molde cubos de hielo, silicona

art. dim. cm.

41515-18 11,7x11,7x5

For 4 cubes 4,7 cm. – Per 4 cubi 4,7 cm.



Mold for ice-cubes, silicone

Stampo cubetti ghiaccio, silicone
Eiswürfel-Former, Silikon
Moule à glaçons, silicone
Molde cubitos de hielo, silicona

art. dim. cm.

41515-20 27x13,5x3,5

For 21 cubes 3 cm. – Per 21 cubetti 3 cm.



Mold for ice-cubes, silicone

Stampo cubetti ghiaccio, silicone
Eiswürfel-Former, Silikon
Moule à glaçons, silicone
Molde cubitos de hielo, silicona

art. dim. cm.

41515-21 25x12x3

For 32 cubes 2,5 cm. – Per 32 cubetti 2,5 cm.



SS

Ice tongs

Molla ghiaccio
Eiszange
Pince à glace
Pinza hielo

art. l. cm. col.

41518G12 16 ●

41518C12 16 ●

41518B12 16 ●



SS

Ice tongs, antique

Molla ghiaccio, antique
Eiszange, Antique
Pince à glace, antique
Pinza hielo, antique

art. l. cm.

41518A12 16



Ice bucket with tongs

Secchio ghiaccio e pinza
Eiseimer mit Eiszange
Seau à glace avec pince
Cubo hielo con pinza

art. Ø mm. h. cm. lt.

41513-13 14 22 1,3

Noble plastic jacket highly chrome plated with special insulated plastic insert. – Camicia in materiale plastico, finitura cromata lucida con speciale inserto termico.



PP

SAN

Ice box

Secchio ghiaccio
Eisbox
Seau à glace
Cubitera

art. dim. cm. lt.

41512-50 27x27x15 5,4

With drainer. – Con griglia.



SS

Ice bucket

Secchio ghiaccio
Eisbehälter
Seau à glace
Cubitera hielo

art. Ø cm. h. cm.

46116-15● 12,5 13





SS

Ice bucket
Secchio ghiaccio
Eisbehälter
Seau à glace
Cubitera hielo

art.	Ø cm.	h. cm.	lt.	col.
41513G20	15	14	2	●
41513C20	15	14	2	●
41513B20	15	14	2	●



SS

Ice bucket, antique
Secchio ghiaccio, antique
Eisbehälter, Antique
Seau à glace, antique
Cubitera hielo, antique

art.	Ø cm.	h. cm.	lt.
41513A20	15	14	2



Bar organizer
Porta oggetti da bar
Bar-Behälter
Présentoir de bar
Dispensador bar

art.	dim. cm.
44102-24	24x14,5x11



ABS

Smoking gun
Affumicatore
Räuchergerät
Pistolet à fumer
Ahumador aromatizador

art.	dim. cm.
49923-00	16,2x5,5x12,5

DC6V - 3,0L/min. Ideal for flavoring and smoking liquid and solid products, such as: cocktails, vegetables, meat and fish. – Ideale per aromatizzare e affumicare prodotti liquidi e solidi, come: cocktail, verdure, carne e pesce.



Smoking chips
Segatura aromatizzata
Aromatisiertes Sägemehl
Sciure aromatisée
Serrín aromatizado

art.	ml.
49923-99	4x250

Mesquite/Hickory/Oak/Cherry. – Mesquite/Hickory/Rovere/Ciliegio.



Cocktail cover
Cloche per affumicatore
Cocktail Räucherglocke
Cloche à fumée
Campana para ahumado

art.	Ø cm.	h. cm.
49923-01	12	11
49923-02	12	16

Glass cover, wood base ø 15 cm.
Cloche vetro, base legno ø 15 cm.



PC

Cocktail cover

Cloche per affumicatore
Cocktail Räucherglocke
Cloche à fumée
Campana para ahumado

art.	Ø cm.	h. cm.
49924-21	21	17
49924-31	30	22
49924-36	36	27



Skull dash bottle

Bottiglia angostura teschio
Schädel Dash Bottle
Dash bottle crâne
Dash bottle cráneo

art.	ml.
41680-03	30
41680-06	60
41680-12	120



Atomizer dash bottle

Bottiglia angostura spray
Bitter Flasche Atomizer
Vaporisateur d'angostura
Botella angostrura spray

art.	ml.
41681-10	100



Atomizer dash bottle

Bottiglia angostura spray
Bitter Flasche Atomizer
Vaporisateur d'angostura
Botella angostrura spray

art.	h. cm.	ml.
41681-11	15	50



Atomizer dash bottle

Bottiglia angostura spray
Bitter Flasche Atomizer
Vaporisateur d'angostura
Botella angostrura spray

art.	Ø cm.	h. cm.	ml.	col.
41681-12	7	10	100	●



Atomizer dash bottle

Bottiglia angostura spray
Bitter Flasche Atomizer
Vaporisateur d'angostura
Botella angostrura spray

art.	Ø cm.	h. cm.	ml.	col.
41681-13	3,4	9,6	100	●





Dash bottle

Bottiglia angostura
Bitter Flasche
Dash bottle
Botella angostrura

art.	ml.
41681-06	150



Dash Bottle

Bottiglia angostura
Bitter Flasche
Dash Bottle
Botella Angostrura

art.	dim. cm.	ml.
41681-01	6,5x6,5x10	100



Dash Bottle

Bottiglia angostura
Bitter Flasche
Dash Bottle
Botella Angostrura

art.	Ø cm.	h. cm.	ml.
41681-03	8,5	15	280



Dash Bottle

Bottiglia angostura
Bitter Flasche
Dash Bottle
Botella Angostrura

art.	dim. cm.	ml.
41681-02	6x5x15	200

Without pourer. – Senza dosatore.



Dash Bottle

Bottiglia angostura
Bitter Flasche
Dash Bottle
Botella Angostrura

art.	Ø cm.	h. cm.	ml.
41681-04	6,2	10	100

Without pourer. – Senza dosatore.



Bottle pourer

Tappo versatore
Ausgiesser
Bouchon verseur
Tapón vertedor

art.
41681-99



Flair bottle

Flair bottle
Flair bottle
Flair bottle
Flair bottle

art.	lt.
44108-01	0,75



Store & pour container

Contentitore versatore
Dosier-Vorratsbehälter, komplett
Bouteille verseuse
Recipiente vertedor

art.	Ø cm.	h. cm.	lt.	col.
44106W05	9,0	26	0,5	○
44106W10	9,0	33	1,0	○
44106W20	12,5	35	2,0	○
44106W25	12,5	39	2,5	○

PE



Store & pour container

Contentitore versatore
Dosier-Vorratsbehälter, komplett
Bouteille verseuse
Recipiente vertedor

art.	Ø cm.	h. cm.	lt.	col.
44106G05	9,0	26	0,5	●
44106G10	9,0	33	1,0	●
44106G20	12,5	35	2,0	●
44106G25	12,5	39	2,5	●

PE



PE

Store & pour container

Contentore versatore
Dosier-Vorratsbehälter, komplett
Bouteille verseuse
Recipiente vertedor

art.	Ø cm.	h. cm.	lt.	col.
44106Y05	9,0	26	0,5	●
44106Y10	9,0	33	1,0	●
44106Y20	12,5	35	2,0	●
44106Y25	12,5	39	2,5	●



PE

Store & pour container

Contentore versatore
Dosier-Vorratsbehälter, komplett
Bouteille verseuse
Recipiente vertedor

art.	Ø cm.	h. cm.	lt.	col.
44106R05	9,0	26	0,5	●
44106R10	9,0	33	1,0	●
44106R20	12,5	35	2,0	●
44106R25	12,5	39	2,5	●



PE

Store & pour container

Contentore versatore
Dosier-Vorratsbehälter, komplett
Bouteille verseuse
Recipiente vertedor

art.	Ø cm.	h. cm.	lt.	col.
44106O05	9,0	26	0,5	●
44106O10	9,0	33	1,0	●
44106O20	12,5	35	2,0	●
44106O25	12,5	39	2,5	●



PE

Store & pour container

Contentore versatore
Dosier-Vorratsbehälter, komplett
Bouteille verseuse
Recipiente vertedor

art.	Ø cm.	h. cm.	lt.	col.
44106B05	9,0	26	0,5	●
44106B10	9,0	33	1,0	●
44106B20	12,5	35	2,0	●
44106B25	12,5	39	2,5	●



PE

Storage canister

Contentore di riserva
Vorratsbehälter
Réipient réserve
Recipiente reserva

art.	Ø cm.	h. cm.	lt.	col.
44107W05	9,0	9,5	0,5	○
44107W10	9,0	16	1,0	○
44107W20	12,5	20	2,0	○
44107W25	12,5	23	2,5	○



PE

Storage canister

Contentore di riserva
Vorratsbehälter
Réipient réserve
Recipiente reserva

art.	Ø cm.	h. cm.	lt.	col.
44107G05	9,0	9,5	0,5	●
44107G10	9,0	16	1,0	●
44107G20	12,5	20	2,0	●
44107G25	12,5	23	2,5	●



PE

Storage canister

Contentore di riserva
Vorratsbehälter
Réipient réserve
Recipiente reserva

art.	Ø cm.	h. cm.	lt.	col.
44107Y05	9,0	9,5	0,5	●
44107Y10	9,0	16	1,0	●
44107Y20	12,5	20	2,0	●
44107Y25	12,5	23	2,5	●



PE

Storage canister

Contentore di riserva
Vorratsbehälter
Réipient réserve
Recipiente reserva

art.	Ø cm.	h. cm.	lt.	col.
44107R05	9,0	9,5	0,5	●
44107R10	9,0	16	1,0	●
44107R20	12,5	20	2,0	●
44107R25	12,5	23	2,5	●



PE

Storage canister

Contentore di riserva
Vorratsbehälter
Réipient réserve
Recipiente reserva

art.	Ø cm.	h. cm.	lt.	col.
44107O05	9,0	9,5	0,5	●
44107O10	9,0	16	1,0	●
44107O20	12,5	20	2,0	●
44107O25	12,5	23	2,5	●





PE

Storage canister

Contentitore di riserva
Vorratsbehälter
Réceptient réserve
Recipiente reserva

art.	Ø cm.	h. cm.	lt.	col.
44107B05	9,0	9,5	0,5	●
44107B10	9,0	16	1,0	●
44107B20	12,5	20	2,0	●
44107B25	12,5	23	2,5	●



PS

Pouring container cap

Tappo per versatore
Dosier-Behälterstopfen
Bouchon à bouteille verseuse
Tapón para recipiente vertedor

art.	pcs/pz
44106-12	12



PS

PP

Condiment holder

Portacondimenti
Bar-Beilagenbehälter
Boîte à condiments
Caja condimentos

art.	dim. cm.	comp.
44103-03	49x15x9	3
44103-04	49x15x9	4
44103-06	49x15x9	6



SS

Condiment holder

Portacondimenti
Bar-Beilagenbehälter
Boîte à condiments
Caja condimentos

art.	dim. cm.	comp.
41782-04	32x16x10	4
41782-05	39x16x10	5
41782-06	47x16x10	6

Inserts in PP. – Inserti in PP.



Glass rimmer

Bordatore bicchieri
Bar-Kombination Salz-/Zuckerumrand
Système de girvage de verres
Ribeteador de vasos

art.	Ø cm.
44101-03	15,5



PE

Bar liner

Tappeto sottobicchieri
Gläsermatte
Revêtement de bar
Tapete para vasos

art.	dim. cm.
44099-03	60x1300



Bar mat, non-slip

Tappeto antiscivolo componibile
Gläserabstellmatte, rutschfest
Tapis antidérapant, composable
Alfombra antiderrapante, componible

art.	dim. cm.
44100-04	30x30



Bar runner

Tappetino bar
Gläserabstellmatte
Tapis à verres
Tapete para vasos

art.	dim. cm.
44100-01	68x8
44100-02	45x30



Barman's set, 20 pcs

Valigia Barman, 20 pz
Barman-Koffer, 20 Stk.
Mallette de barman, 20 pièces
Alfombra, 20 piezas

art.

14480-20

Incl. / Comprende: 41479-05 boston shaker, 41480-05 shaker, 41503-22 pestello/ice beater, 41595-20 cucchiaino magico/magic spoon, 41603-00 colino/strainer, 41604-00 misurino/measuring cup, 41605-00 miscelatore/mixing spoon, 41606-00 & 41606-01 spremilimone/lemon squeezer, 41606-02 spremi lime/lemon squeezer, 41608-04 tappo/champagne stopper, 41699-06 cavatappi/corkscrew, 44058-10 tappo dosatore/dispenser plug 10ml, 48280-02 levacapsule/bottle opener, 48280-97 coltello barman/barman knife, 48280-92 rigalimoni/lemon stripper, 48280-96 pelarance/orange peeler, 12550-04 cucchiaino ghiaccio/ice spoon, 12550-36 cucchiaino bibita/cocktail spoon, 12550-55 molla ghiaccio/ice tong.



Barman apron

Grembiule barman
Barman Schurz
Tablier barman
Mandil barman

art.	dim. cm.	col.
48543-01	70x40	●
48543-02	70x40	●

65% polyester/poliestere. – 35% cotton/cotone. 195 g/mq.



SS

Speed rack

Rastrelliera
Flaschenregal
Rack à bouteilles
Estantería bar para botellas

art.	dim. cm.	bot.
44060-51	56x21x15,5	2x 6



SS

Speed rack

Rastrelliera
Flaschenregal
Rack à bouteilles
Estantería bar para botellas

art.	dim. cm.	bot.
44060-50	56x10,5x15,5	6
44060-80	81x10,5x15,5	8
44060-99	107x10,5x15,5	10





SS

Glass shelf rack

Rastrelliera, fissaggio sospeso
Gläserhalter Regalmontage
Rack à verres fixation suspendue
Rack de copas, fijación techo

art. dim. cm.
44060-01 45x31,6x5,5

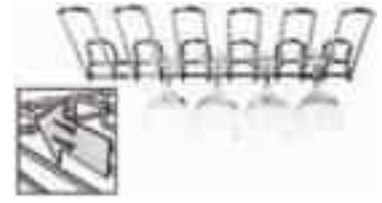

SS

Glass wall rack

Rastrelliera, fissaggio murale
Gläserhalter Wandmontage
Rack à verres fixation murale
Rack de copas, fijación mural

art. dim. cm.
44060-02 45x31,6x5,6



SS

Glass cleaning brush

Lavabicchieri
Gläserpüler
Brosse lave-verres
Cepillo lavavasos

art. dim. cm.
44135-02 38x18x29



Glass cleaning brush, nylon

Spazzole lavabicchieri, nylon
Spazzole lavabicchieri, nylon
Bierglasbürstenständer, nylon
Brosse lave-verres, nylon
Cepillo lavavasos, nilón

art. h. cm.
44130-02 16,5
44130-03 21,5



Glass cleaning brush, nylon-aluminum

Spazzola lavabicchieri, nylon-alluminio
Bierglasbürstenständer, Nylon-Aluminium
Brosse lave-verres, nylon-alu
Cepillo lavavasos, nilón-aluminio

art. Ø cm. h. cm.
44130-01 15 19



Aluminum wall mounted bottle rack

Supporto a parete, alluminio
Alu-Wandständer
Support pour bouteilles en aluminium
Soporte mural, aluminio

art. l. cm. bot.
44056-04 41 4
44056-06 67 6

Dispensers not included. – Dosatori non inclusi.



Revolving bottle rack

Supporto rotante da banco
Theken-Drehständer vollständig
Support rotatif de comptoir
Soporte giratorio

art. h. cm. bot.
44057-04 70 4
44057-06 70 6

Dispensers not included. – Dosatori non inclusi.



Standard aluminum support

Supporto bottiglia, alluminio
Alu-Standard Ständer,
Support en aluminium
Soporte de botella, aluminio

art. col.
44056-01 ●
44056-11 ●
44056-21 ●

Universal fitting, shelf or wall mounting.
Fissaggio universale, a ripiano o parete.



Chrome plated dispenser

Dosatore cromato
Verchromter Dosierer
Doseur chromé
Dosificador cromado

art.	ml.
44055-10	10
44055-50	50



Chrome plated dispenser

Dosatore cromato
Verchromter Dosierer
Doseur chromé
Dosificador cromado

art.	ml.
44055-20	20
44055-25	25
44055-30	30
44055-35	35
44055-40	40



Dispenser

Dosatore
Dosierer
Doseur
Dosificador

art.	ml.	col.
44055G30	30	●
44055G40	40	●
44055C30	30	●
44055C40	40	●



Automatic dispenser plug

Tappo dosatore automatico
Automatischer Portionierer
Bouchon doseur automatique
Bola dosificadora

art.	ml.
44058-20	20
44058-25	25
44058-30	30



Automatic dispenser plug

Tappo dosatore automatico
Automatischer Portionierer
Bouchon doseur automatique
Bola dosificadora

art.	ml.
44058-10	10
44058-40	40
44058-50	50



Bottle pourer with cap

Tappo versatore con chiusura
Ausgießer mit Kappe
Bouchon avec clapet
Tapón vertedor con clerre

art.	pcs/pz
44111-02	2

SS





Free flow pourer

Tappo versatore continuo
Permanentenausgiesser
Bouchon verseur continu
Vertedor continuo

art.	pcs/pz	col.
44110-01	12	●
44110-02	12	●
44110-03	12	●



Free flow pourer

Tappo versatore continuo
Permanentenausgiesser
Bouchon verseur continu
Vertedor continuo

art.	pcs/pz	col.
44110-04	12	●
44110-05	12	○
44110-06	12	●



Free flow pourer

Tappo versatore continuo
Permanentenausgiesser
Bouchon verseur continu
Vertedor continuo

art.	pcs/pz
44110-00	12



Pourer

Tappo versatore
Ausgiesser
Bouchon verseur
Tapón vertedor

art.	U. Pack	col.
44119-01	6	●
44119-02	6	●
44119-03	6	●
44119-04	6	●
44119-06	6	●



Pourer

Tappo versatore
Ausgiesser
Bouchon verseur
Tapón vertedor

art.
44114-01
44114-02
44114-03

SS



Pourer set 3 pcs

Tappo versatore set 3 pz
Ausgiesser Satz 3 Stk
Bouchon verseur set 3 pcs
Tapón vertedor 3 piezas

art.	col.
44114G03	●
44114C03	●



Measure pourer

Tappo metrico
Portioniererausgiesser
Bouchon doseur
Caños dosificador

art.	ml.	U. Pack	col.
44118-10	10	6	●
44118-20	20	6	●
44118-25	25	6	●
44118-30	30	6	●



Measure pourer

Tappo metrico
Portioniererausgiesser
Bouchon doseur
Caños dosificador

art.	ml.	U. Pack	col.
44118-35	35	6	●
44118-40	40	6	●
44118-50	50	6	○



Whiskey pourer

Tappo versatore
Ausgiesser
Bouchon verseur
Vertedor

art.	pcs/pz	col.
44112-01	12	●
44112-02	12	○



Champagne stopper
Tappo spumante
Sektflaschenstopfen
Bouchon à champagne
Tapón Champaña

art.
41608-20



Champagne stopper, chrome plated
Tappo spumante, cromato
Sektflaschenstopfen, verchromt
Bouchon à champagne chromé
Tapón Champaña cromado

art.
41608-04



Champagne stopper
Tappo spumante
Sektflaschenstopfen
Bouchon à champagne
Tapón Champaña

art. col.
41608G04 ●
41608C04 ●



SS

Champagne stopper
Tappo spumante
Sektflaschenstopfen
Bouchon à champagne
Tapón Champaña

art.
46796-00



SS

Wine stopper
Tappo vino
Weinflaschenstopfen
Bouchon à vin
Tapón vino

art.
41608-03



SS

ABS

Vacuum pump wine preserver + 2 stoppers
Pompa sottovuoto per vino + 2 tappi
Wein-Vakuum-Pumpe + 2 Stopfen
Pompe à vide d'air + 2 bouchons
Bomba vacío vino + 2 tapones

art.
41500-00



Set 2 stoppers
Set 2 tappi
Satz 2 Stopfen
Jeu 2 bouchons
Juego 2 tapones

art.
41500-AA



Foil cutter
Taglia capsula
Folienschneider
Coupe-capsules
Cortacápsulas

art.
49858-07



Winged corkscrew
Cavatappi a doppia leva
Korkenzieher mit Doppelhebel
Tire-bouchon à double levier
Sacacorchos a doble palanca

art.
41699-10

Zinc alloy, chromed. – Cromato.



Waiter's corkscrew
Cavatappi cameriere
Kellner Korkenzieher
Tire-bouchon sommelier
Sacacorchos camarero

art.
41699-20



Waiter's corkscrew
Cavatappi cameriere
Kellner Korkenzieher
Tire-bouchon sommelier
Sacacorchos camarero

art.
41699-06



Bottle opener with collector box
Levacapsule con contenitore di raccolta
Flaschenöffner mit Sammelbehälter
Décapsuleur avec récipient de récupération
Abridor de botellas + caja de recuperación

art. dim. cm.
48223-00 12x7x30





SS

Bottle opener
Levacapsule
Flaschenöffner
Décapsuleur
Abrebotellas

art.	dim. cm.	col.
41699-18	18x4	●
41699G18	18x4	●
41699C18	18x4	●
41699B18	18x4	●



SS

Bottle opener
Levacapsule
Flaschenöffner
Décapsuleur
Abrebotellas

art.	dim. cm.
41699-12	11x4



SS

Bottle opener
Levacapsule
Flaschenöffner
Décapsuleur
Abrebotellas

art.	dim. cm.
41699-04	11x4



Bar blade holster with belt clip
Fondina per levacapsule
Flaschenöffner-Halter
Etui pour décapsuleur
Funda para abrebotellas

art.	dim. cm.
41699-13	11x4



Bottle opener, nickelplated
Levacapsule nichelato
Flaschenöffner, vernickelt
Décapsuleur, nickelé
Abrebotellas, niquelado

art.
41699-03



SS

Etlund

Can punch and bottle opener
Apriscatole/levacapsule
Dosen-/Flaschenöffner
Ouvre-boîte/décapsuleur
Abrelatas/botellas

art.
49860-00



B

Tepokushi skewers
Spiedini tepokushi
Tepokushi Spieße
Brochettes tepokushi
Pinchos tepokushi

art.	l. cm.	pcs/pz
48300-43	9	100
48300-33	15	100



B

Noshikushi skewers
Spiedini noshikushi
Noshikushi Spieße
Brochettes noshikushi
Pinchos noshikushi

art.	l. cm.	pcs/pz
48300-42	10,5	100



W

Toothpicks
Stuzzicadenti
Zahnstocher
Cure-dents
Palillos

art.	l. cm.	pcs/pz
48306-01	9	1000

Birch, double pointed, individually wrapped.
Betulla, 2 punte, imbustati singolarmente.



SS

Cocktail picks, 4 pcs
Spiedini cocktail, 4 pz
Cocktailspiese, 4 Stk
Brochettes, 4 pièces
Palos, 4 piezas

art.	l. cm.	col.
41492-00	10	●
41492G00	10	●
41492C00	10	●
41492B00	10	●



PC

Glass clip holder
Clip reggibicchieri
Glashalter
Clip porte-verre
Soporte para vidrio

art.	U. Pack
44048-99	100



PP

Non-slip tray, round

Vassoio antiscivolo, rotondo
Tablett, rutschfest, rund
Plateau antidérapant, rond
Bandeja antideslizante, redonda

art. Ø cm.

41863-35 35



PP

Non-slip tray, oval

Vassoio antiscivolo, ovale
Tablett, rutschfest, oval
Plateau antidérapant, ovale
Bandeja antideslizante, oval

art. dim. cm.

41864-56 56x68



PP

Non-slip tray, rectangular

Vassoio antiscivolo, rettangolare
Tablett, rutschfest, rechteckig
Plateau antidérapant, rectangulaire
Bandeja antideslizante, rectangular

art. dim. cm.

41865-40 41x56,5



PP

Fast food tray

Vassoio fast food
Serviertablett, Fast Food
Plateau fast food
Bandeja fast food

art. dim. cm.

41860-36 27x36,5

41860-43 30,7x43,5

41860-47 35,5x47



PP

Fast food tray

Vassoio fast food
Serviertablett, Fast Food
Plateau fast food
Bandeja fast food

art. dim. cm.

41861-44 30,7x44



PP

Gastronorm tray

Vassoio Gastronorm
Serviertablett, Gastronorm
Plateau Gastronorm
Bandeja Gastronorm

art. dim. cm. col.

41862B11 53x32,5x1,6 ●

41862C11 53x32,5x1,6 ●

41862G11 53x32,5x1,6 ●



PP

Euronorm tray

Vassoio Euronorm
Serviertablett, Euronorm
Plateau Euronorm
Bandeja Euronorm

art. dim. cm. col.

41862B53 53x37x1,6 ●

41862C53 53x37x1,6 ●

41862G53 53x37x1,6 ●

PADERNO®

WORLD CUISINE

THE ART OF
MIXOLOGY
Bar Collection

Paderno offers a selection of bar tools for mixology enthusiasts in the trendy Gold and Copper colors. Each set comes with a stylish packaging. Designed as perfect gift ideas.

Paderno propone una selezione di utensili bar per gli appassionati del mixology nelle colorazioni di tendenza Gold e Copper. Ogni set ha un packaging con grafica raffinata. Pensati come perfette idee regalo.





Set 2 Martini cups

Set coppe Martini 2 pz
Set Martini Gläser 2 Stk
Set verres à Martini 2 pcs
Set copas Martini 2 pz

art. col.
41494-C2 ●



Set 2 Martini cups

Set coppe Martini 2 pz
Set Martini Gläser 2 Stk
Set verres à Martini 2 pcs
Set copas Martini 2 pz

art. col.
41494-G2 ●



Set 2 Champagne Glasses

Set flûte Champagne 2 pz
Set Champagne Gläser 2 Stk
Set verres à Champagne 2 pcs
Set copas Champagne 2 pz

art. col.
41493-C2 ●



Set 2 Champagne Glasses

Set flûte Champagne 2 pz
Set Champagne Gläser 2 Stk
Set verres à Champagne 2 pcs
Set copas Champagne 2 pz

art. col.
41493-G2 ●



Martini set 3 pcs

Set mixology 3 pz, Martini
Set Mixology 3 Stk, Martini
Set mixology 3 pcs, Martini
Set mixology 3 pz, Martini

art. col.
41494-C3 ●



Martini set 3 pcs

Set mixology 3 pz, Martini
Set Mixology 3 Stk, Martini
Set mixology 3 pcs, Martini
Set mixology 3 pz, Martini

art. col.
41494-G3 ●



Mixology set 3 pcs, Starter

Set mixology 3 pz, Starter
Set Mixology 3 Stk, Starter
Set mixology 3 pcs, Starter
Set mixology 3 pz, Starter

art. col.
41484-C3 ●



Mixology set 3 pcs, Starter

Set mixology 3 pz, Starter
Set Mixology 3 Stk, Starter
Set mixology 3 pcs, Starter
Set mixology 3 pz, Starter

art. col.
41484-G3 ●





Mixology set 4 pcs, Parisian

Set mixology 4 pz, Parisian
Set Mixology 4 Stk, Parisian
Set mixology 4 pcs, Parisian
Set mixology 4 pz, Parisian

art. col.
41461-C4 ●



Mixology set 4 pcs, Parisian

Set mixology 4 pz, Parisian
Set Mixology 4 Stk, Parisian
Set mixology 4 pcs, Parisian
Set mixology 4 pz, Parisian

art. col.
41461-G4 ●



Mixology set 5 pcs, Boston

Set mixology 5 pz, Boston
Set Mixology 5 Stk, Boston
Set mixology 5 pcs, Boston
Set mixology 5 pz, Boston

art. col.
41467-C5 ●



Mixology set 5 pcs, Boston

Set mixology 5 pz, Boston
Set Mixology 5 Stk, Boston
Set mixology 5 pcs, Boston
Set mixology 5 pz, Boston

art. col.
41467-G5 ●



Mixology set 5 pcs, Crystal

Set mixology 5 pz, Crystal
Set Mixology 5 Stk, Crystal
Set mixology 5 pcs, Crystal
Set mixology 5 pz, Crystal

art. col.
41514-C5 ●



Mixology set 5 pcs, Crystal

Set mixology 5 pz, Crystal
Set Mixology 5 Stk, Crystal
Set mixology 5 pcs, Crystal
Set mixology 5 pz, Crystal

art. col.
41514-G5 ●





Mixology set 5 pcs, Parisian

Set mixology 5 pz, Parisian
Set Mixology 5 Stk, Parisian
Set mixology 5 pcs, Parisian
Set mixology 5 pz, Parisian

art. col.

41461-C5 ●



Mixology set 5 pcs, Parisian

Set mixology 5 pz, Parisian
Set Mixology 5 Stk, Parisian
Set mixology 5 pcs, Parisian
Set mixology 5 pz, Parisian

art. col.

41461-G5 ●



Mixology set 6 pcs, Ice

Set mixology 6 pz, Ice
Set Mixology 6 Stk, Ice
Set mixology 6 pcs, Ice
Set mixology 6 pz, Ice

art. col.

41461-C6 ●



Mixology set 6 pcs, Ice

Set mixology 6 pz, Ice
Set Mixology 6 Stk, Ice
Set mixology 6 pcs, Ice
Set mixology 6 pz, Ice

art. col.

41461-G6 ●



Mixology set 8 pcs, Cobbler

Set mixology 8 pz, Cobbler
Set Mixology 8 Stk, Cobbler
Set mixology 8 pcs, Cobbler
Set mixology 8 pz, Cobbler

art. col.

41480-C8 ●



Mixology set 8 pcs, Cobbler

Set mixology 8 pz, Cobbler
Set Mixology 8 Stk, Cobbler
Set mixology 8 pcs, Cobbler
Set mixology 8 pz, Cobbler

art. col.

41480-G8 ●



BAR HAPPY HOUR

APPETIZERS
AMUSE-BOUCHE



SS

Snack holder
Porta snack
Snack-Behälter
Conteneur à snack
Contenedor para snack

art.	Ø cm.	h. cm.	lt.
41524-09	9	8,5	0,33



SS

Snack holder, 4 pcs
Porta snack, 4 pz
Snack-Behälter, 4 Stk
Conteneur à snack, 4 pcs
Contenedor para snack, 4 pz

art.	Ø cm.	h. cm.	lt.
41524-04	7	6,5	0,15



SS

Snack holder
Porta snack
Snack-Behälter
Conteneur à snack
Contenedor para snack

art.	dim. cm.
41527-12	10x8,5x6,5
41527-13	13x10,5x9



SS

Snack holder
Porta snack
Snack-Behälter
Conteneur à snack
Contenedor para snack

art.	dim. cm.
41527-10	21,5x10,5x4,5
41527-11	26x13x5



SS

Snack holder
Porta snack
Snack-Behälter
Conteneur à snack
Contenedor para snack

art.	Ø cm.	h. cm.
41523-08	8	7,5
41523-09	9	8,5



SS

Snack holder
Mini tegame
Mini-Servierfanne
Conteneur à snack
Contenedor para snack

art.	dim. cm.	lt.
41522-14	14,5x9,5x4,5	0,5



SS
PVD

Snack holder
Porta snack
Snack-Behälter
Conteneur à snack
Contenedor para snack

art.	dim. cm.	col.
41527G10	21,5x10,5x4,5	●
41527G11	26x13x5	●



SS
PVD

Snack holder
Porta snack
Snack-Behälter
Conteneur à snack
Contenedor para snack

art.	dim. cm.	col.
41527G12	10x8,5x6,5	●
41527G13	13x10,5x9	●



SS
PVD

Snack holder
Porta snack
Snack-Behälter
Conteneur à snack
Contenedor para snack

art.	Ø cm.	h. cm.	col.
41523G08	8	7,5	●
41523G09	9	8,5	●



SS

Snack holder
Porta snack
Snack-Behälter
Conteneur à snack
Contenedor para snack

art.	Ø cm.	h. cm.	lt.
41524-10	9,5	11,5	0,45



SS

Snack holder
Porta snack
Snack-Behälter
Conteneur à snack
Contenedor para snack

art.	Ø cm.	h. cm.	lt.
41524-11	8,5	8,5	0,35



SS

Snack holder
Porta snack
Snack-Behälter
Conteneur à snack
Contenedor para snack

art.	Ø cm.	h. cm.	lt.
41524-12	8,5	8,5	0,35



SS
PVD

Snack holder
Porta snack
Snack-Behälter
Conteneur à snack
Contenedor para snack

art.	Ø cm.	h. cm.	lt.	col.
41524C10	9,5	11,5	0,45	●



SS
PVD

Snack holder
Porta snack
Snack-Behälter
Conteneur à snack
Contenedor para snack

art.	Ø cm.	h. cm.	lt.	col.
41524C11	8,5	8,5	0,35	●



SS
PVD

Snack holder
Porta snack
Snack-Behälter
Conteneur à snack
Contenedor para snack

art.	Ø cm.	h. cm.	lt.	col.
41524C12	8,5	8,5	0,35	●



NEW

Snack holder
Ciotola porta snack
Snack-Schale
Bol à snack
Cuenco para snack

art.	dim. cm.	lt.	col.
41532G15	15,5x12x5,5	0,7	●
41532G23	23x15,5x6	1,4	●

Aluminum, hammered surface.
Alluminio, superficie martellata.



NEW

Snack holder
Ciotola porta snack
Snack-Schale
Bol à snack
Cuenco para snack

art.	dim. cm.	lt.	col.
41532C15	15,5x12x5,5	0,7	●
41532C23	23x15,5x6	1,4	●

Aluminum, hammered surface.
Alluminio, superficie martellata.



NEW

Snack holder
Ciotola porta snack
Snack-Schale
Bol à snack
Cuenco para snack

art.	dim. cm.	lt.	col.
41532B15	15,5x12x5,5	0,7	●
41532B23	23x15,5x6	1,4	●

Aluminum, hammered surface.
Alluminio, superficie martellata.



NEW

SS



Snack dispenser

Porta snack
Snackspender
Distributeur de snacks
Dispensador de snacks

art.	Ø cm.	h. cm.	lt.	col.
41521-01	8,5	15,5	0,35	●
41521-02	8,5	15,5	0,35	●

Glass container, screw cap, opening oval 3,5x2,5 cm. – Contenitore vetro, tappo a vite, apertura ovale 3,5x2,5 cm.



W

5 pcs tasting/dessert set

Set 5 pz aperitivo/degustazione
5 Stück Verkostung/Dessert Set
Set 5 pcs dégustation/dessert
Juego de degustación/postre 5 pz

art.	dim. cm.	ml.
41205-07	42x9x1,8	4x68



W

4 pcs canning jar set

Set 4 pz barattoli degustazione
4 Stück Verkostung-Gläser Set
Set 4 pcs dégustation/dessert
Juego de degustación/postre 4 pz

art.	dim. cm.	ml.
41205-08	27,5x11x4	3x200



W

7 pcs canning jar set

Set 7 pz barattoli degustazione
5 Stück Verkostung-Gläser Set
Set 7 pcs dégustation/dessert
Juego de degustación/postre 5 pz

art.	dim. cm.	ml.
41205-09	43x10x3	6x100



AR

5 pcs tasting/dessert set

Set 5 pz aperitivo/degustazione
5 Stück Verkostung/Dessert Set
Set 5 pcs dégustation/dessert
Juego de degustación/postre 5 pz

art.	dim. cm.	ml.
41205-01	35x10	4x43



AR

5 pcs tasting/dessert set

Set 5 pz aperitivo/degustazione
5 Stück Verkostung/Dessert Set
Set 5 pcs dégustation/dessert
Juego de degustación/postre 5 pz

art.	dim. cm.	ml.
41205-02	35x10	4x110



W

5 pcs tasting/dessert set

Set 5 pz aperitivo/degustazione
5 Stück Verkostung/Dessert Set
Set 5 pcs dégustation/dessert
Juego de degustación/postre 5 pz

art.	dim. cm.	ml.
41205-03	49x9,7x1,8	4x176



W

4 pcs tasting/dessert set

Set 4 pz aperitivo/degustazione
4 Stück Verkostung/Dessert Set
Set 4 pcs dégustation/dessert
Juego de degustación/postre 4 pz

art.	dim. cm.	ml.
41205-05	45x11x1,8	3x147



W

4 pcs tasting/dessert set

Set 4 pz aperitivo/degustazione
4 Stück Verkostung/Dessert Set
Set 4 pcs dégustation/dessert
Juego de degustación/postre 4 pz

art.	dim. cm.	ml.
41205-04	35x11x1,8	3x147



W

5 pcs tasting/dessert set

Set 5 pz aperitivo/degustazione
5 Stück Verkostung/Dessert Set
Set 5 pcs dégustation/dessert
Juego de degustación/postre 5 pz

art.	dim. cm.	ml.
41205-06	45x9x1,8	



W

4 pcs tasting/dessert set

Set 4 pz aperitivo/degustazione

4 Stück Verkostung/Dessert Set

Set 4 pcs dégustation/dessert

Juego de degustación/postre 4 pz

art. dim. cm.

41205-10 35x11x2



W

7 pcs tasting/dessert set

Set 7 pz aperitivo/degustazione

7 Stück Verkostung/Dessert Set

Set 7 pcs dégustation/dessert

Juego de degustación/postre 7 pz

art. dim. cm.

41206-04 38x12x1

**TRAYS WOOD EFFECT
VASSOI EFFETTO LEGNO**



MF

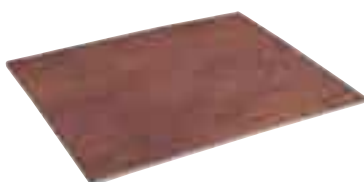

GN

Rectangular platter

Vassoio rettangolare

Tablett, Rechteckig

Plateau rectangulaire

Bandeja rectangular

art. dim. cm.

44473-31 53x32,5x0,8

44473-32 32,5x26,5x0,8

44473-34 26x16x0,8

44473-33 32,5x17,5x0,8



Round platter

Vassoio rotondo

Tablett, Rund

Plateau rond

Bandeja redonda

art. Ø cm. h. cm.

44473-02 33 0,8

44473-03 43 0,8



Round platter with handle

Vassoio rotondo con manico
Tablett, Rund mit Griff
Plateau rond avec manche
Bandeja redonda con mango

art.	Ø cm.	h. cm.
44473-05	38	1,5



Rectangular platter with handle

Vassoio rettangolare con manico
Tablett Rechteckig mit Griff
Plateau rectangulaire avec manche
Bandeja rectangular con mango

art.	dim. cm.
44473-07	53x20x1,5



Rectangular platter with handle

Vassoio rettangolare con manico
Tablett Rechteckig mit Griff
Plateau rectangulaire avec manche
Bandeja rectangular con mango

art.	dim. cm.
44473-08	61x20x1,5

WOODEN SERVING BOARDS
TAGLIERI IN LEGNO



Each piece is carefully handcrafted therefore size, shape and finish may vary from piece to piece. Wash by hand with warm soapy water, do not to soak.

Ogni pezzo è realizzato a mano quindi dimensioni, forma e finitura variano da pezzo a pezzo. Lavare a mano con acqua tiepida e sapone. Non mettere in ammollo.



Serving board

Tagliere
Servierbrett
Planche de service
Tabla

art.	dim. cm.
41327-01	45,5x20

Acacia wood. – Acacia.



Bowl

Ciotola
Schüssel
Bol
Bol

art.	Ø cm.
41327-02	25,5

Acacia wood. – Acacia.



Serving board

Tagliere
Servierbrett
Planche de service
Tabla

art.	Ø cm.
41327-03	20,0
41327-04	25,5
41327-05	30,5

Acacia wood. – Acacia.



W

Serving board
Tagliere
Servierbrett
Planche de service
Tabla

art.	Ø cm.
41327-06	19,5
41327-07	24,0
41327-08	29,5

Acacia wood. – Acacia.



W

Serving board
Tagliere
Servierbrett
Planche de service
Tabla

art.	Ø cm.
41327-09	24
41327-10	30

Acacia wood. – Acacia.



W

Serving board
Tagliere
Servierbrett
Planche de service
Tabla

art.	dim. cm.
41320-25	25x17x1,5

Olive wood. – Ulivo.



W

Serving board
Tagliere
Servierbrett
Planche de service
Tabla

art.	dim. cm.	l.
41321-40	40x15x1,5	40+11
41321-44	44x20x2	44+12

Olive wood. – Ulivo.



W

Serving board
Tagliere
Servierbrett
Planche de service
Tabla

art.	dim. cm.	l.
41322-19	19x12,2x1,5	19+6
41322-25	25x16x1,5	25+8
41322-31	31x20x1,5	31+9

Olive wood. – Ulivo.



W

Serving board
Tagliere
Servierbrett
Planche de service
Tabla

art.	dim. cm.
41325-20	20x12x3

Birch wood. – Betulla.



W

Serving board
Tagliere
Servierbrett
Planche de service
Tabla

art.	dim. cm.
41325-30	30x20x3

Birch wood. – Betulla.



W

Serving board
Tagliere
Servierbrett
Planche de service
Tabla

art.	dim. cm.
41325-40	40x15x3

Birch wood. – Betulla.



W

AR

Serving board set 4 pieces
Tagliere set 4 pezzi
Servierbrett, 4-tlg
Planche de service, set 4 pièces
Tabla juego 4 piezas

art.	dim. cm.
41206-01	35x23x1,5

Pine wood & slate. – Pino & ardesia.



W

AR

Serving board set 3 pieces
Tagliere set 3 pezzi
Servierbrett, 3-tlg
Planche de service, set 3 pièces
Tabla juego 3 piezas

art.	dim. cm.
41206-02	37x17x1,8

Pine wood & slate. – Pino & ardesia.



NEW

W

AR

Tagliere
Servierbrett
Planche de service
Tabla

art.	dim. cm.
41326-26	26x18x2

Acacia wood & slate. – Acacia & ardesia.



BAR HAPPY HOUR



NEW
W
AR

Tagliere
Servierbrett
Planche de service

Tabla

art. dim. cm.

41326-33 33x20x2

Acacia wood & slate. – Acacia & ardesia.



NEW
W
AR

Tagliere
Servierbrett
Planche de service

Tabla

art. dim. cm.

41326-40 40x15x2

Acacia wood & slate. – Acacia & ardesia.



NEW
W
AR

Tagliere
Servierbrett
Planche de service

Tabla

art. dim. cm.

41326-43 43x12x2

Acacia wood & slate. – Acacia & ardesia.



W

Coffee set 4 pieces

Servizio caffè 4 pezzi

Kaffeaset 4 Stk

Service à café 4 pièces

Servicio de café 4 piezas

art. dim. cm.

41206-03 25x18,7x2,5

Acacia wood. – Acacia.



AR
W

Serving board

Tagliere

Servier-Brett

Planche de service

Tabla

art. dim. cm.

41326-30 30,5x13x1,5

Acacia wood & slate. – Acacia & ardesia.



AR
W

Serving board

Tagliere

Servier-Brett

Planche de service

Tabla

art. dim. cm.

41326-36 36,5x15x1,5

Acacia wood & slate. – Acacia & ardesia.



AR
W

Serving board

Tagliere

Servier-Brett

Planche de service

Tabla

art. dim. cm.

41326-42 42x18x1,5

Acacia wood & slate. – Acacia & ardesia.



W
AR

Serving stand 2-tier

Alzata 2 piani

Servierstand 2-stufig

Support 2 niveaux

Soporte 2 pisos

art. dim. cm.

41207-02 25x4,5x34,5

Beech. Slate cm. 31x13 - 41x18.

Faggio. Ardesia cm. 31x13 - 41x18.



W
AR

Serving stand 3-tier

Alzata 3 piani

Servierstand 3-stufig

Support 3 niveaux

Soporte 3 pisos

art. dim. cm.

41207-03 25x4,5x54

Beech. Slate cm. 21x8 - 31x13 - 41x18.

Faggio. Ardesia cm. 21x8 - 31x13 - 41x18.



W

Serving board with cast iron surface

Tagliere con inserto ghisa

Servierplatte mit Gusseiseneinsatz

Planche à servir avec insert en fonte

Tabla con inserto de hierro fundido

art. Ø cm. Por.

44250S30 30 1-2

Iroko wood. – Iroko.



W

Serving board with cast iron surface

Tagliere con inserto ghisa

Servierplatte mit Gusseiseneinsatz

Planche à servir avec insert en fonte

Tabla con inserto de hierro fundido

art. dim. cm. Por.

44248S60 60x15x2,5 4

Iroko wood. – Iroko.



W

Serving board with cast iron surface

Tagliere con inserto ghisa

Servierplatte mit Gusseiseneinsatz

Planche à servir avec insert en fonte

Tabla con inserto de hierro fundido

art. Ø cm. h. cm. Por.

44254-30 31 2,5 1

Iroko wood. – Iroko.



W

Wooden service platter

Tagliere legno
Holzbrett
Planche à servir en bois
Tabla madera

art.	dim. cm.	Por.
44258-60	60x15	4-6

Iroko wood. – Iroko.



W

Wooden service platter

Tagliere legno
Holzbrett
Planche à servir en bois
Tabla madera

art.	dim. cm.	Por.
44264-35	25x35x1,8	1-2

Iroko wood. – Iroko.



W

Wooden service platter

Tagliere legno
Holzbrett
Planche à servir en bois
Tabla madera

art.	dim. cm.	Por.
44265-35	25x35x1,8	1-2

Iroko wood. – Iroko.



W

Twice sauce pot wooden platter

Porta coppette doppio
Schale-Träger doppel
Support à bol double
Soporte copa doble

art.	Ø cm.	dim. cm.
44256-02	5,5	8x20x1,8

Beechwood. – Faggio.



W

Triple sauce pot wooden platter

Porta coppette triplo
Schale-Träger dreifach
Support à bol triple
Soporte copa triple

art.	Ø cm.	dim. cm.
44256-03	5,5	8x28x1,8

Beechwood. – Faggio.



W

Quartet sauce pot wooden platter

Porta coppette quadruplo
Schale-Träger vierfach
Support à bol quadruple
Soporte copa cuatro veces

art.	Ø cm.	dim. cm.
44256-04	5,5	8x36x1,8

Beechwood. – Faggio.



MF

Bowl

Ciotola
Schale
Bol
Bol

art.	Ø cm.	h. cm.	lt.
44846B05	5,5	4	0,02



MF

Bowl

Ciotola
Schale
Bol
Bol

art.	dim. cm.	lt.
44466-11	7,5x7x4,5	0,05



MF

Bowl

Ciotola
Schale
Bol
Bol

art.	dim. cm.	lt.
44466-12	11,5x7,5x3	0,06



MF

Bowl

Ciotola
Schale
Bol
Bol

art.	dim. cm.	lt.
44466-13	11,5x6x5,5	0,04



MF

Bowl

Ciotola
Schale
Bol
Bol

art.	dim. cm.	lt.
44466-14	8,5x7x6	0,07



MF

Bowl

Ciotola
Schale
Bol
Bol

art.	dim. cm.	lt.
44466-15	8x8x4	0,1



NATURAL ELEGANT



A valid alternative to glass. Elegant and unbreakable ideals for HORECA pastry and ice cream sector. Made with high quality material that confers beside resistance also glossiness and perfect transparency. Bisphenol free. Thermal tolerance -18°C +70°C. Dishwasher safe: up to 50 washes. Can be reused several times and once disposed, they are 100% recyclable. Made in Italy.

La valida alternativa al vetro. Eleganti ed infrangibili ideali per il settore HORECA della pasticceria e gelateria. Realizzati con materiale di alta qualità che gli conferisce oltre alla resistenza anche lucidità e trasparenza. Privi di Bisfenolo. Tolleranza termica -18°C +70°C. Lavabili in lavastoviglie: fino a 50 lavaggi. Possono essere riutilizzati più volte e, una volta gettati, sono riciclabili al 100%. Prodotti made in Italy.



Tasting glass

Bicchierino degustazione
Verkostung Glas
Verrine dégustation
Vaso degustación

art.	dim. cm.	h. cm.	ml.
48368-05	6,4x4,6	5,3	50
48368-12	8,5x6	7,0	120
48368-20	10x7	8,3	200

Set 100 pcs. – Conf. 100 pz.



Tasting glass

Bicchierino degustazione
Verkostung Glas
Verrine dégustation
Vaso degustación

art.	dim. cm.	h. cm.	ml.
48369-08	6,3x6,9	5,7	85
48369-14	7,3x8,1	6,7	140
48369-20	9x8,3	7,4	200

Set 100 pcs. – Conf. 100 pz.



Tasting dish

Piattino degustazione
Verkostung Teller
Assiette dégustation
Platillo degustación

art.	dim. cm.	h. cm.
48372-08	8,5x9,6	2

Set 100 pcs. – Conf. 100 pz.



Tasting bowl

Ciotolina degustazione
Verkostung Schale
Bol dégustation
Bol degustación

art.	dim. cm.	h. cm.	ml.
48359-01	6,5x6,5	1,5	15

Set 100 pcs. – Conf. 100 pz.



Tasting glass

Bicchierino degustazione
Verkostung Glas
Verrine dégustation
Vaso degustación

art.	Ø cm.	h. cm.	ml.
48354-01	4	8,5	80

Set 100 pcs. – Conf. 100 pz.



Tasting bowl

Ciotolina degustazione
Verkostung Schale
Bol dégustation
Bol degustación

art.	dim. cm.	h. cm.	ml.
48357-01	7,5x7,5	3	50

Set 100 pcs. – Conf. 100 pz.



Tasting glass

Bicchierino degustazione
Verkostung Glas
Verrine dégustation
Vaso degustación

art.	dim. cm.	h. cm.	ml.
48353-01	8,1x8,3	6,5	175

Set 100 pcs. – Conf. 100 pz.



Tasting dish

Piattino degustazione
Verkostung Teller
Assiette dégustation
Platillo degustación

art.	dim. cm.	h. cm.	ml.
48355-01	8,5x8,5	1,5	20

Set 100 pcs. – Conf. 100 pz.



Tasting bowl

Ciotolina degustazione
 Verkostung Schale
 Bol dégustation
 Bol degustación

art.	dim. cm.	h. cm.	ml.
48358-01	10,5x5	3	11

Set 100 pcs. – Conf. 100 pz.



Tasting bowl

Ciotolina degustazione
 Verkostung Schale
 Bol dégustation
 Bol degustación

art.	dim. cm.	h. cm.	ml.
48356-01	8,5x8,5	3	30

Set 100 pcs. – Conf. 100 pz.

FINGER FOOD - GLASS



Set 12 Mini Glasses

Conf. 12 bicchierini
 Satz 12 Stk Snack-/Dessertgläsern
 Set 12 mini verres
 Juego 12 vasitos

art.	Ø cm.	h. cm.	ml.
41204-01	5	5,5	100



Set 12 Mini Glasses

Conf. 12 bicchierini
 Satz 12 Stk Snack-/Dessertgläsern
 Set 12 mini verres
 Juego 12 vasitos

art.	Ø cm.	h. cm.	ml.
41204-02	3,5	9	76



Set 12 Mini Glasses

Conf. 12 bicchierini
 Satz 12 Stk Snack-/Dessertgläsern
 Set 12 mini verres
 Juego 12 vasitos

art.	Ø cm.	h. cm.	ml.
41204-03	6,5	5	110



Set 12 Mini Glasses

Conf. 12 bicchierini
Satz 12 Stk Snack-/Dessertgläsern
Set 12 mini verres
Juego 12 vasitos

art.	Ø cm.	h. cm.	ml.
41204-04	7	5	100



Set 12 Mini Glasses

Conf. 12 bicchierini
Satz 12 Stk Snack-/Dessertgläsern
Set 12 mini verres
Juego 12 vasitos

art.	Ø cm.	h. cm.	ml.
41204-05	3,8	8	110



Set 12 Mini Glasses

Conf. 12 bicchierini
Satz 12 Stk Snack-/Dessertgläsern
Set 12 mini verres
Juego 12 vasitos

art.	Ø cm.	h. cm.	ml.
41204-06	4,5x3,5	8,5	65



Set 12 Mini Glasses

Conf. 12 bicchierini
Satz 12 Stk Snack-/Dessertgläsern
Set 12 mini verres
Juego 12 vasitos

art.	Ø cm.	h. cm.	ml.
41204-07	4,5	7	77



Set 12 Mini Glasses

Conf. 12 bicchierini
Satz 12 Stk Snack-/Dessertgläsern
Set 12 mini verres
Juego 12 vasitos

art.	Ø cm.	h. cm.	ml.
41204-08	5	6,5	80



Set 12 Mini Glasses

Conf. 12 bicchierini
Satz 12 Stk Snack-/Dessertgläsern
Set 12 mini verres
Juego 12 vasitos

art.	Ø cm.	h. cm.	ml.
41204-09	4,5	6,5	110



Set 12 Mini Glasses

Conf. 12 bicchierini
Satz 12 Stk Snack-/Dessertgläsern
Set 12 mini verres
Juego 12 vasitos

art.	Ø cm.	h. cm.	ml.
41204-10	7	5,5	90



Set 12 Mini Glasses

Conf. 12 bicchierini
Satz 12 Stk Snack-/Dessertgläsern
Set 12 mini verres
Juego 12 vasitos

art.	Ø cm.	h. cm.	ml.
41204-11	4,5	8,5	100



Set 12 Mini Glasses

Conf. 12 bicchierini
Satz 12 Stk Snack-/Dessertgläsern
Set 12 mini verres
Juego 12 vasitos

art.	Ø cm.	h. cm.	ml.
41204-12	5,5	3,5	100



FINGER FOOD



Oval tweested dish
Ovalina goccia

art. dim. cm.
41200-01 9x5x3



Eye dish
Ovalina occhio

art. dim. cm.
41200-02 8,1x5,6x3



Egg dish
Tegamino 2/m

art. dim. cm.
41200-03 8,5x6,8x2



Oval dish
Ovalina

art. dim. cm.
41200-04 10x5,5x2,7



Soya sauce dish
Rettangolare

art. dim. cm.
41200-05 8x5,5x1,8



Square dish
Piatino quadro

art. dim. cm.
41200-06 8x8x2,4



Oriental square dish
Quadrato orientale

art. dim. cm.
41200-07 7,5x7,5x3



Dye dish
Cubo

art. dim. cm.
41200-08 5,2x5,2x4



Chao dish
Quadrato punte

art. dim. cm.
41200-09 8x8x5



Tear dish
Foglia

art. dim. cm.
41200-10 8x7x3,4



Nem dish
Tronchetto

art. dim. cm.
41200-11 5,5x4,5x6,5



Rectangular w/lid
Rettangolare c/cop

art. dim. cm.
41200-13 10x5,5x4,5



Square pan with lid
Quadra c/cop

art. dim. cm.
41200-14 9x3,6x4,5



Oval pan with lid
Ovale c/cop

art. dim. cm.
41200-15 10,5x7x4,5



Rectangular pan
Casseruola rett.

art. dim. cm.
41200-16 10x5,5x4,5



Square pan
Casseruola quadra

art. dim. cm.
41200-17 9x3,6x4,5





Oval pan
Casseruola ovale

art. dim. cm.
41200-18 10,5x7x4,5



Footed square dish
Quadrato

art. dim. cm.
41200-32 10x10x1,2



Fish dish
Piattino pesce

art. dim. cm.
41200-33 10,5x5x1,6



Small pan
Tegamino

art. dim. cm.
41200-34 9,7x6x2,6



Mini pasta bowl
Mini ciotola pasta

art. dim. cm.
41200-36 10x2,5x1,6



Square dish
Coppetta quadra

art. dim. cm.
41200-40 7x7x3,5



Round bowl
Bolo tondo

art. Ø cm. h. cm.
41200-41 7 4,5



Small pot
Mini pentola

art. dim. cm.
41200-49 5x5x5



Small bucket
Secchiello

art. dim. cm.
41200-50 6x6x4,5



Colander
Colapasta

art. dim. cm.
41200-51 7x7x4,5



Fruit case
Cassetta frutta

art. dim. cm.
41200-52 8x5,5x2,3



Tin with lid
Scatoletta c/cop

art. dim. cm.
41200-53 13,5x5,5x5



Tin with lid
Scatoletta c/cop

art. Ø cm. h. cm.
41200-54 8 4



French fries bowl
Vaschetta patatine

art. dim. cm.
41200-58 13x10x4



Rectangular w/handles
 Rettangolare c/m

art. dim. cm.
41200-59 14x10x3,5



Rectangular lid
Coperchio rett.

art. dim. cm.
41200-60 14x10



Oval w/handles
Ovale c/m

art. dim. cm.
41200-61 14x9,5x3,5



Oval lid
Coperchio ovale

art. dim. cm.
41200-62 14x9,5



Round w/handles
Tonda c/m

art. Ø cm. h. cm.
41200-63 13 5,5



Round lid
Coperchio tondo

art. Ø cm.
41200-64 13



Ramequin
Ramequin

art. Ø cm. h. cm.
41200-46 10 5,0
41200-47 9 5,0
41200-48 8 4,5



Vintage tray
Vassoietto vintage

art. dim. cm.
41200-55 15x10x1,7



Vintage tray
Vassoietto vintage

art. dim. cm.
41200-56 22,3x14x2



Vintage tray
Vassoietto vintage

art. dim. cm.
41200-57 29,5x20,5x2

TABLE TOP TAVOLA

SERVING ITEMS
COMPLEMENTI



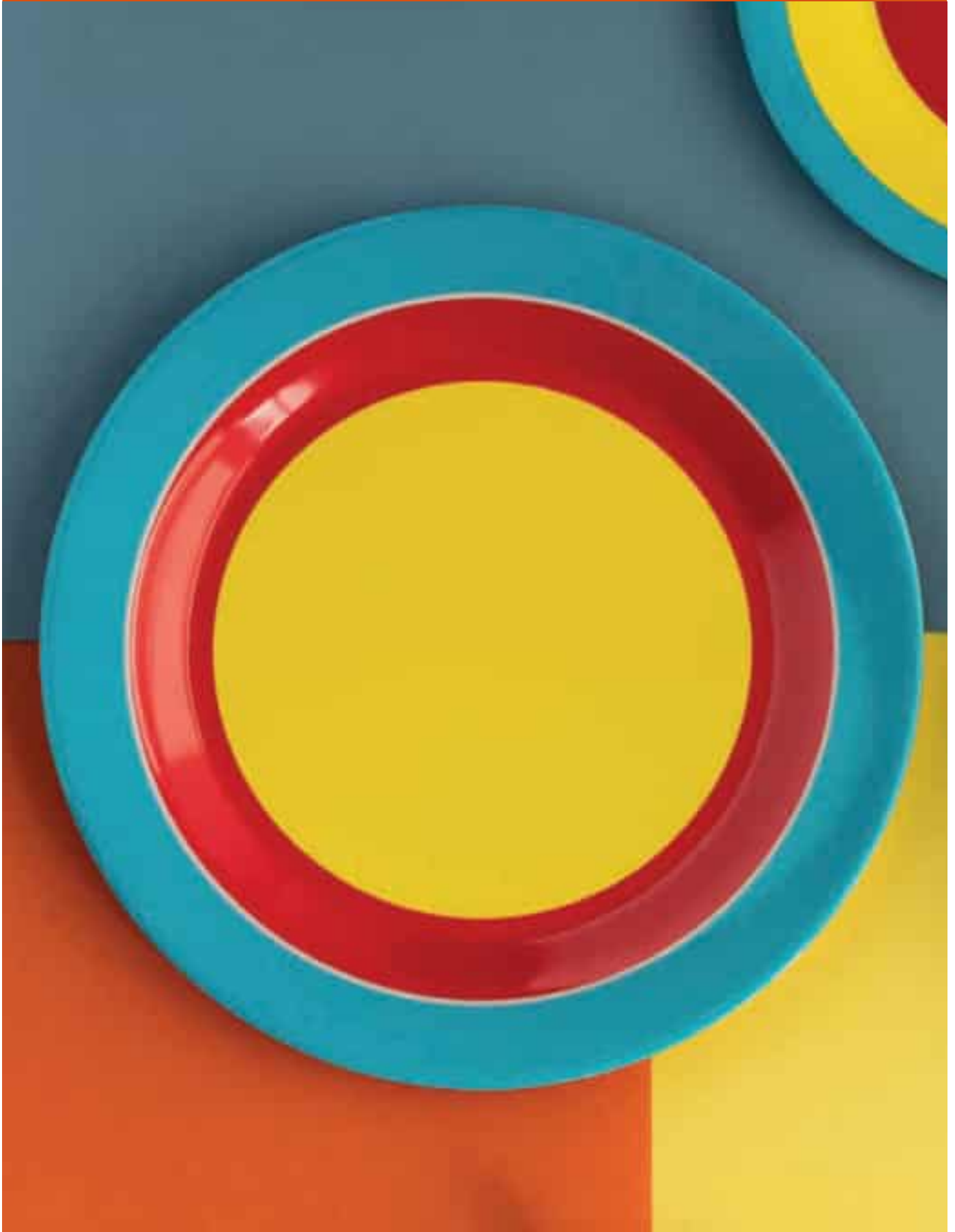

A practical and funny series for children but not only. Simple shapes, bright colors. The decoration in its simplicity of the circles, brings a good mood to the table. Suitable for both indoor and outdoor spaces, but also a smart choice for catering services and large numbers.

Una serie pratica e divertente per i bambini ma non solo. Forme semplici, colori sgargianti. Il decoro nella sua semplicità dei cerchi, porta buonumore a tavola. Adatta sia agli spazi indoor che outdoor, ma anche una scelta intelligente per servizi di catering e grandi numeri.

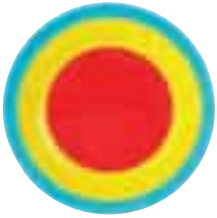

Flat plate

Piatto piano
Teller flach
Assiette plate
Plato llano

art.	Ø cm.
17621-01	20



Flat plate

Piatto piano
Teller flach
Assiette plate
Plato llano

art.	Ø cm.
17621-02	25

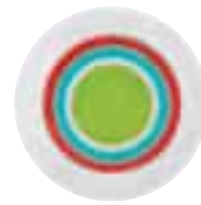

Soup plate

Piatto fondo
Teller tief
Assiette creuse
Plato hondo

art.	Ø cm.	h. cm.
17621-09	17	4



Bowl

Ciotola
Schüssel
Bol
Cuenco

art.	Ø cm.	h. cm.	ml.
17621-80	11	5,5	260



Cup

Tazza
Tasse
Tasse
Taza

art.	Ø cm.	h. cm.	ml.
17621-40	7	7,5	180



Tumbler

Bicchiere
Becher
Gobelet
Vaso

art.	Ø cm.	h. cm.	ml.
17621-44	8,5	9	260

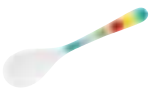

Spoon

Cucchiaio
Löffel
Cuillère
Cuchara

art.	dim. cm.
17621-90	14,5x3



Fork and spoon

Forchetta e cucchiaio
Gabel und Löffel
Fourchette et cuillère
Tenedor y cuchara

art.	dim. cm.
17621-92	19x3,5



TABLE MATS & RUNNERS
TOVAGLIETTE & RUNNER

Material: 50% polyester - 50% Polyvinyl chloride

Materiale: 50% Poliestere - 50% Cloruro di polivinile



Table mat - Light melange

Tovaglietta - Melange chiaro

art.	dim. cm.	pcs/pz
42950-01	42x33	6



Table mat - Brown

Tovaglietta - Marrone

art.	dim. cm.	pcs/pz
42950-04	42x33	6



Table mat - Sandy

Tovaglietta - Beige

art.	dim. cm.	pcs/pz
42950-02	42x33	6



Table mat - Beige-Grey

Tovaglietta - Beige-Grigio

art.	dim. cm.	pcs/pz
42950-05	42x33	6



Table mat - Coral

Tovaglietta - Corallo

art.	dim. cm.	pcs/pz
42950-08	42x33	6



Table mat - Black

Tovaglietta - Nero

art.	dim. cm.	pcs/pz
42950-03	42x33	6



Table mat - Grey

Tovaglietta - Grigio

art.	dim. cm.	pcs/pz
42950-06	42x33	6



Table mat - White pin-striped

Tovaglietta - Gessato bianco

art.	dim. cm.	pcs/pz
42950-09	42x33	6



RUNNER - Sandy

Beige

art.	dim. cm.
42950-92	42x180



RUNNER - Black

Nero

art.	dim. cm.
42950-93	42x180



RUNNER - Brown

Marrone

art.	dim. cm.
42950-94	42x180



NATURAL SLATE
 ARDESIA NATURALE

Excellent coldness retention, food safe. The edges of the trays are broken to show the typical structure of the natural material. With anti-slip feet. No dishwasher proof. Material thickness: 6-9 mm.

Eccellente immagazzinamento del freddo, idonei al contatto alimentare. Gli angoli dei piani sono spezzati per evidenziare la tipica struttura del materiale. Con piedini antiscivolo. Non idonei al lavaggio in lavastoviglie. Spessore: 6-9 mm.



Tray
 Vassoio
 Platte
 Plateau
 Placa

art.	dim. cm.
41585-37	20x10



Tray
 Plancia
 Platte
 Plateau
 Placa

art.	GN	dim. cm.
41585-11	1/1	53x32,2
41585-12	1/2	32,5x26,5
41585-13	1/3	32,5x17,5
41585-24	1/4	26,5x16,5
41585-23	2/4	53x16,2



Square tray
 Plancia quadra
 Platte, viereckig
 Plateau carré
 Placa cuadrada

art.	dim. cm.
41585-25	25x25
41585-30	30x30



Rectangular tray

Plancia rettangolare
Platte, rechteckig
Plateau rectangulaire
Placa rectangular

art.	dim. cm.
41585-45	45x30



Round tray

Plancia tonda
Platte, rund
Plateau ronde
Placa redonda

art.	Ø cm.
41586-22	22
41586-28	28
41586-33	33
41586-38	38



Square tray, 4 pcs set

Plancia quadra, set 4 pz
Platte, viereckig, Satz 4 Stk
Plateau carré, set 4 pcs
Placa cuadrada, juego 4 pz

art.	dim. cm.
41585-10	10x10



Tray with holes

Vassoio con fori
Platte mit Absätze
Plat avec trous
Placa con agujeros

art.	Ø cm.	dim. cm.
41585-01	6	25x12



Tray with holes

Vassoio con fori
Platte mit Absätze
Plat avec trous
Placa con agujeros

art.	Ø cm.	dim. cm.
41585-02	6	15x8



Tray with holes

Vassoio con fori
Platte mit Absätze
Plat avec trous
Placa con agujeros

art.	Ø cm.	dim. cm.
41585-03	6	28x10



Tray with dome

Piatto con campana
Platte mit Glashaube
Plat avec cloche
Bandeja y campana

art.	Ø cm.	h. cm.
41585-00	10,5	8



Tray 2-tier

Alzata 2 piani
Etagère 2-stufig
Présentoir 2 niveaux
Bandeja 2 niveles

art.	Ø cm.	h. cm.
41587-25	20-25	24



Tray 3-tier

Alzata 3 piani
Etagère 3-stufig
Présentoir 3 niveaux
Bandeja 3 niveles

art.	Ø cm.	h. cm.
41587-03	20-25-30	34

NEW

Acacia wood.



Revolving platter

Supporto girevole
Servierplatt, drehbar
Présentoir tournant
Soporte rotatorio

art.	Ø cm.	h. cm.
41587-32	32	2,5



Tray

Plancia
Platte
Plateau
Placa

art.	dim. cm.	fits/per
41585-51	24x15	44842-30
41585-52	47x10	44843-24
41585-53	26,5x20,5	44843-12
41585-54	32x12	44842-35



BLACK & BROWN
 NERO & MARRONE

The rough surface structure creates a natural appearance. The black bowls and trays with brown border stage your dishes in a very stylish way.

La struttura superficiale ruvida crea un aspetto naturale. Le ciotole e i vassoi neri con bordo marrone mettono in scena le pietanze in modo molto elegante.



Bowl
 Ciotola
 Schüssel
 Bol
 Bol

art.	Ø cm.	h. cm.	lt.
44480-10	14	6,0	0,3
44480-11	19	8,0	0,8
44480-12	21	8,5	1,0



Bowl
 Ciotola
 Schüssel
 Bol
 Bol

art.	Ø cm.	h. cm.	lt.
44480-15	11	3,5	0,13
44480-16	14	4,0	0,20
44480-20	30,5	8,5	2,00



Tray
 Vassoio
 Tablett
 Plateau
 Bandeja

art.	dim. cm.
44480-03	14,5x14,5x2



Tray
 Vassoio
 Tablett
 Plateau
 Bandeja

art.	dim. cm.
44480-06	26,5x16,5x4



Bowl
 Ciotola
 Schüssel
 Bol
 Bol

art.	Ø cm.	h. cm.	lt.
44480-07	8,5	2,5	0,05



Bowl
 Ciotola
 Schüssel
 Bol
 Bol

art.	Ø cm.	h. cm.	lt.
44480-08	11,5	3	0,04



Bowl

Ciotola
Schüssel
Bol
Bol

art.	Ø cm.	h. cm.	lt.
44480-09	11	5,5	0,2



Tray

Vassoio
Tablett
Plateau
Bandeja

art.	dim. cm.
44480-19	32,5x23,5x4,5



Bowl

Ciotola
Schüssel
Bol
Bol

art.	dim. cm.	lt.
44480-00	25,5x14x5,5	0,4
44480-01	36x19x8	0,9



Tray

Vassoio
Tablett
Plateau
Bandeja

art.	dim. cm.
44480-04	22,5x15x3
44480-05	27,5x11x2



Tray

Vassoio
Tablett
Plateau
Bandeja

art.	dim. cm.
44480-17	19,5x9,5x2
44480-18	39x16x3



**CLAY
ARGILLA**



Serving and buffet items, an imitation of clay, either white with brown border or dark brown with terracotta border. The surface is inside and outside fine-matt. Feels like real clay.

Piatti da servizio e buffet, un'imitazione dell'argilla, sia bianchi con bordo marrone o moro con bordo terracotta. La superficie interna ed esterna è finemente opaca. Effetto argilla anche al tatto.



Soup plate

Piatto fondo
Teller tief
Assiette creuse
Plato hondo

art.	Ø cm.	h. cm.	lt.	col.
44478-20	20,5	3	0,5	●



Soup plate

Piatto fondo
Teller tief
Assiette creuse
Plato hondo

art.	Ø cm.	h. cm.	lt.	col.
44478-21	20,5	3	0,5	●



Flat plate

Piatto piano
Teller flach
Assiette plate
Plato llano

art.	dim. cm.	col.
44478-22	14x13x2,5	●



Flat plate
Piatto piano
Teller flach
Assiette plate
Plato llano

art.	dim. cm.	col.
44478-23	14x13x2,5	●



Bowl
Ciotola
Schüssel
Bol

art.	Ø cm.	h. cm.	lt.	col.
44478-24	12,5	6	0,37	●
44478-26	16	7	0,70	●



Bowl
Ciotola
Schüssel
Bol

art.	Ø cm.	h. cm.	lt.	col.
44478-25	12,5	6	0,37	●
44478-27	16	7	0,70	●



Bowl
Ciotola
Schüssel
Bol
Bol

art.	Ø cm.	h. cm.	lt.	col.
44478-28	16,5	4	0,5	●



Bowl
Ciotola
Schüssel
Bol
Bol

art.	Ø cm.	h. cm.	lt.	col.
44478-29	16,5	4	0,5	●



Bowl
Ciotola
Schüssel
Bol
Bol

art.	Ø cm.	h. cm.	lt.	col.
44478-30	21	8	1,45	●



Bowl
Ciotola
Schüssel
Bol
Bol

art.	Ø cm.	h. cm.	lt.	col.
44478-31	21	8	1,45	●



Bowl
Ciotola
Schüssel
Bol
Bol

art.	dim. cm.	lt.	col.
44478-32	30,5x10x7,5	0,17	●
44478-34	42x14x9,5	0,65	●



Bowl
Ciotola
Schüssel
Bol
Bol

art.	dim. cm.	lt.	col.
44478-33	30,5x10x7,5	0,17	●
44478-35	42x14x9,5	0,65	●



GLASS JARS
VASETTI WECK



Perfect for the sterilization and pasteurization of any product, fruit, vegetables, but also meat, fish, foie gras or delicatessen products. They are suitable for serving jams and sauces: they also look beautiful on the table. They are perfect for cooking and serving on the table. They are 100% pure glass, so they do not release harmful substances into food, they resist very high temperatures (up to 200°C in the oven), they can be washed in the dishwasher (including seal).

Perfetti per la sterilizzazione e la pastorizzazione di qualsiasi prodotto, di frutta verdura ma anche di carne, pesce, foie gras o prodotti di salumeria. Sono indicati per servire marmellate e salse di accompagnamento: inoltre belli da vedere sulla tavola. Sono i vasetti perfetti per la vasocottura e per servire in tavola. Sono al 100% in puro vetro, quindi non rilasciano sostanze nocive nel cibo, resistono a temperature elevatissime (fino a 200°C in forno), si possono lavare in lavastoviglie (guarnizione compresa).



Glasses with cover, 12 pcs
Vasetti con coperchio, 12 pz
Gläser mit Deckel, 12er Set
Verres avec couvercle, 12 pcs
Vasos con tapa, 12 pz

art.	Ø cm.	h. cm.	ml.
41589-08	6	5,5	80
41589-14	6	7,0	140



Glasses with cover, 12 pcs
Vasetti con coperchio, 12 pz
Gläser mit Deckel, 12er Set
Verres avec couvercle, 12 pcs
Vasos con tapa, 12 pz

art.	Ø cm.	h. cm.	ml.
41589-16	6	8	160



Glasses with cover, 12 pcs
Vasetti con coperchio, 12 pz
Gläser mit Deckel, 12er Set
Verres avec couvercle, 12 pcs
Vasos con tapa, 12 pz

art.	Ø cm.	h. cm.	ml.
41589-20	9	6	200



Glasses with cover, 12 pcs
Vasetti con coperchio, 12 pz
Gläser mit Deckel, 12er Set
Verres avec couvercle, 12 pcs
Vasos con tapa, 12 pz

art.	Ø cm.	h. cm.	ml.
41589-22	7	8	220



Glasses with cover, 12 pcs
Vasetti con coperchio, 12 pz
Gläser mit Deckel, 12er Set
Verres avec couvercle, 12 pcs
Vasos con tapa, 12 pz

art.	Ø cm.	h. cm.	ml.
41589-07	5,5	6	75



Glasses with cover, 6 pcs
Vasetti con coperchio, 6 pz
Gläser mit Deckel, 6er Set
Verres avec couvercle, 6 pcs
Vasos con tapa, 6 pz

art.	Ø cm.	h. cm.	ml.
41589-29	9	9	290



Glasses with cover, 6 pcs
Vasetti con coperchio, 6 pz
Gläser mit Deckel, 6er Set
Verres avec couvercle, 6 pcs
Vasos con tapa, 6 pz

art.	Ø cm.	h. cm.	ml.
41589-59	11	9	580



Glasses with cover, 2 pcs
Vasetti con coperchio, 2 pz
Gläser mit Deckel, 2er Set
Verres avec couvercle, 2 pcs
Vasos con tapa, 2 pz

art.	Ø cm.	h. cm.	ml.
41589-58	11	11	580



Glasses with cover, 3 pcs
Vasetti con coperchio, 3 pz
Gläser mit Deckel, 3er Set
Verres avec couvercle, 3 pcs
Vasos con tapa, 3 pz

art.	Ø cm.	h. cm.	ml.
41589-37	11	7,5	370



Glasses with cover, 2 pcs
Vasetti con coperchio, 2 pz
Gläser mit Deckel, 2er Set
Verres avec couvercle, 2 pcs
Vasos con tapa, 2 pz

art.	Ø cm.	h. cm.	ml.
41589-30	11	7,5	370



Glasses with cover, 2 pcs
Vasetti con coperchio, 2 pz
Gläser mit Deckel, 2er Set
Verres avec couvercle, 2 pcs
Vasos con tapa, 2 pz

art.	Ø cm.	h. cm.	ml.
41589-31	11	11	580

S/steel covers. – Coperchi inox.

S/steel covers. – Coperchi inox.



Glasses with cover, 2 pcs
Vasetti con coperchio, 2 pz
Gläser mit Deckel, 2er Set
Verres avec couvercle, 2 pcs
Vasos con tapa, 2 pz

art.	Ø cm.	h. cm.	ml.
41589-34	11	7,5	370

Beech covers. – Coperchi faggio.



Glasses with cover, 2 pcs
Vasetti con coperchio, 2 pz
Gläser mit Deckel, 2er Set
Verres avec couvercle, 2 pcs
Vasos con tapa, 2 pz

art.	Ø cm.	h. cm.	ml.
41589-35	11	11	580

Beech covers. – Coperchi faggio.



Bottles with cover, 6 pcs
Bottigliette con coperchio, 6 pz
Flaschen mit Deckel, 6er Set
Bouteilles avec couvercle, 6 pcs
Botellas con tapa, 6 pz

art.	Ø cm.	h. cm.	ml.
41589-25	6,5	14,5	250



Bottles with cover, 6 pcs

Bottigliette con coperchio, 6 pz
Flaschen mit Deckel, 6er Set
Bouteilles avec couvercle, 6 pcs
Botellas con tapa, 6 pz

art.	Ø cm.	h. cm.	ml.
41589-50	6,5	19	500



Bottles with cover, 6 pcs

Bottigliette con coperchio, 6 pz
Flaschen mit Deckel, 6er Set
Bouteilles avec couvercle, 6 pcs
Botellas con tapa, 6 pz

art.	Ø cm.	h. cm.	ml.
41589-99	6,5	25,5	1000



NEW

Covers, 12 pcs

Coperchi, 12 pz
Deckel, 12er Set
Couvercle, 12 pcs
Tapa, 12 pz

art.	Ø cm.	fits/per
41589-00	7	25/50/99/08
-	-	14/16/22



NEW

Cover

Coperchio
Deckel
Couvercle
Tapa

art.	Ø cm.	fits/per
41589-01	11	37/58

Beech, silicone seal.

Faggio, guarnizione silicone.



NEW

Cover

Coperchio
Deckel
Couvercle
Tapa

art.	Ø cm.	fits/per
41589-02	10,5	37/58

Stainless steel, silicone seal.

Inox, guarnizione silicone.



Rubber rings, 10 pcs

Guarnizioni, 10 pz
Gummidichtringe, 10er Set
Joints, 10 pièces
Juntas, 10 piezas

art.	Ø cm.	fits/per
41589-AA	6	08/14/16
41589-BB	9	20/29
41589-CC	11	37/58/59



Airtight covers, 5 pcs

Coperchi ermetici, 5 pz
Frischhaltedeckel, 5er Set
Couvercles hermétiques, 5 pcs
Tapas herméticas, 5 pz

art.	fits/per
41589-AC	08/14/16 25/50/99



SS

Cover clamps, 8 pcs

Clip, 8 pezzi
Deckel-Klammer, 8er Set
Clips crochets, 5 pcs
Abrazaderas, 8 pz

art.
41589-AB



Glasses (without lid), 12 pcs

Vasetti (senza coperchi), 12 pz
Gläser (ohne Deckel), 12er Set
Verres (sans couvercle), 12 pcs
Vasos (sin tapa), 12 pz

art.	Ø cm.	h. cm.	ml.	
41589-04	5	3,5	35	NEW
41589C08	6	5,5	80	-
41589C16	6	8,0	160	-



SS

Insulated beverage server

Caraffa termica
Thermokanne
Pot isotherme
Jarra térmica

art.	lt.
41650-06	0,6
41650-10	1,0
41650-13	1,5



SS

Insulated beverage server

Caraffa termica
Thermokanne
Pot isotherme
Jarra térmica

art.	lt.
41646-06	0,75
41646-10	1,00
41646-15	1,50
41646-20	2,00



SS

Insulated beverage server

Caraffa termica
Thermokanne
Pot isotherme
Jarra térmica

art.	lt.
42401-10	1,0
42401-15	1,5
42401-20	2,0



SS

Insulated beverage server

Caraffa termica
Thermokanne
Pot isotherme
Jarra térmica

art.	lt.
42405-10	1
42405-20	2



SS

PP

Insulated beverage server

Caraffa termica
Thermokanne
Pot isotherme
Jarra térmica

art.	Ø cm.	h. cm.	lt.
42403-01	16	20	1

8 cups. – 8 tazze.



SS

PP

Insulated beverage server

Caraffa termica
Thermokanne
Pot isotherme
Jarra térmica

art.	Ø cm.	h. cm.	lt.
42403B01	16	20	1

8 cups. – 8 tazze.



SS

French press

Caffettiera pressa filtro
Kaffeebereiter
Cafetière à piston
Jarra para infusiones

art.	ml.	col.
42407-03	350	●
42407-06	600	●



SS

French press

Caffettiera pressa filtro
Kaffeebereiter
Cafetière à piston
Jarra para infusiones

art.	ml.
42408-03	350
42408-06	600
42408-08	800



PC

Water jug

Caraffa
Wasserkrug
Crûche à eau
Jarra agua

art.	Ø cm.	h. cm.	lt.
44999-09	10	15	0,9
44999-16	12	20	1,6



SMMA



Water jug

Caraffa
Wasserkrug
Crûche à eau
Jarra agua

art.	Ø cm.	h. cm.	lt.
44992-03	26	29	3



Water jug
Caraffa
Wasserkrug
Crûche à eau
Jarra agua

art.	Ø cm.	h. cm.	lt.
44994-00	14	29	2,5



Water jug
Caraffa
Wasserkrug
Crûche à eau
Jarra agua

art.	Ø cm.	h. cm.	lt.
44992-02	16,5	26	2



Water jug
Caraffa
Wasserkrug
Crûche à eau
Jarra agua

art.	dim. cm.	lt.
44871-28	12x13,8	0,5
44871-30	17,4x17	1,0
44871-32	18,7x19,8	1,5
44871-34	21,6x18,8	2,0

Withstands temperatures/Termoresistenti da:
-30° +120°C.



PP

Lid
Coperchio
Deckel
Couverture
Tapa

art.	dim. cm.	fits/per	U. Pack
44871-29	9,9x1,4	l. 0,5	10
44871-31	11,2x1,9	l. 1,0	10
44871-33	14x2,4	l. 1,5	10
44871-35	15,9x2,2	l. 2,0	10

Withstands temperatures/Termoresistenti da:
-40° +100°C.



Juice pitcher, glass
Caraffa vetro
Glaskaraffe
Carafe à jus, verre
Jarra zumo, vidrio

art.	Ø cm.	h. cm.	lt.
44995-15	9,5	27	1,5

Stainless steel lid. – Coperchio inox.



Juice pitcher, glass
Caraffa vetro
Glaskaraffe
Carafe à jus, verre
Jarra zumo, vidrio

art.	Ø cm.	h. cm.	lt.
44992-15	10	26	1,5

Stainless steel lid with integrated strainer for cores or ice. – Coperchio inox con filtro integrato per semi o ghiaccio.



Juice pitcher, glass
Caraffa vetro
Glaskaraffe
Carafe à jus, verre
Jarra zumo, vidrio

art.	Ø cm.	h. cm.	lt.
44995-14	16	27	1,4

Spout opens and closes automatically. Chromed foot with cooler, keep drinks chilled up to 4 hours. – Tappo apre e chiude automaticamente. Piede cromato con eutetto, mantiene le bevande refrigerate fino a 4 ore.



Juice pitcher, glass

Caraffa vetro
Glaskaraffe
Carafe à jus, verre
Jarra zumo, vidrio

art.	Ø cm.	h. cm.	lt.
44995-10	9,5	29	1

Spout opens and closes automatically while serving. – Tappo versatore apre e chiude automaticamente.



PC

PP

Juice pitcher with lid

Caraffa con coperchio
Saftkanne mit Deckel
Carafe à jus avec couvercle
Jarra zumo con tapa

art.	Ø cm.	h. cm.	lt.
44993-01	11	30	1,6

Screwed lid, aroma-tight.

Coperchio avvitato, a tenuta di aroma.



NEW

Juice pitcher, glass

Caraffa vetro
Glaskaraffe
Carafe à jus, verre
Jarra zumo, vidrio

art.	Ø cm.	h. cm.	lt.
44992-10	8	25	1

Stainless steel lid. – Coperchio inox.



SS

Tea strainer

Passathé
Teesieb
Passoire à thé
Colador de tè

art.	Ø cm.
41529-05	5



SS

Tea strainer

Passathé
Teesieb
Passoire à thé
Colador de tè

art.	Ø cm.
41530-05	5



SS

Tea strainer

Passathé
Teesieb
Passoire à thé
Colador de tè

art.	Ø cm.
41530-11	5



SS

Tea strainer

Passathé
Teesieb
Passoire à thé
Colador de tè

art.	Ø cm.
41530-07	7,5



SS

Tea strainer

Passathé
Teesieb
Passoire à thé
Colador de tè

art.	Ø cm.
42617-04	4,5
42617-05	5,0
42617-06	6,5
42617-07	7,5

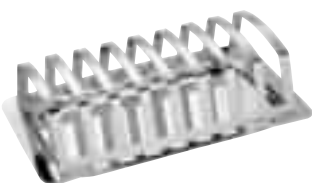

SS

Toast rack

Portatoast
Toastständer
Support pour toast
Porta tostadas

art.	dim. cm.
41599-08	20x11x5,7



SS

Egg cup

Portauovo
Eierbecher
Coquetier
Soporte huevos

art.	Ø cm.
41598-00	8,5



MF

Egg cup, 4 pcs set

Portauovo, set 4 pz
Eierbecher, 4 Stk
Coquetier, set 4 pcs
Soporte huevos, set 4 pz

art.	Ø cm.
41597-04	8,5



SS
PR

Mustard cup
Senapiera
Sensschale
Moutardier
Mostacero

art.	Ø cm.
41564-07	7



SS
PR

Butter cup
Coppa burro
Butterservierer
Coupe à beurre
Copa mantequilla

art.	Ø cm.
41563-07	7



SS
PR

Butter cup
Coppa burro
Butterservierer
Coupe à beurre
Copa mantequilla

art.	Ø cm.
41561-09	9



SS

Gravy boat with foot
Salsiera con piede
Saucière mit Fuss
Saucière sur pied
Salsera con pie

art.	lt.
41615-01	0,15
41615-03	0,25
41615-05	0,45



PR

Soup bowl, lion-headed
Ciotola testa di leone
Suppentasse Löwenkopf
Soupière tête de lion
Tazón cabeza de león

art.	Ø cm.	lt.
44379-03	11	0,35
44379-05	17	0,50



PC

Salad bowl
Insalatiera
Salatschüssel
Saladier
Bol para ensalada

art.	Ø cm.	h. cm.	lt.
44950-15	15,2	5,0	0,6
44950-20	20,3	6,5	1,7
44950-25	25,4	8,0	3,0
44950-30	30,5	10,0	5,5
44950-38	38,1	12,5	10,6



SS

Fruit basket, oval
Cesto frutta, ovale
Obstschale, ovale
Panier à fruits, ovale
Cesta fruta, oval

art.	dim. cm.
42956-19	19x15
42956-24	24,5x18
42956-28	28x21



SS

Fruit basket, round
Cesto frutta, tondo
Obstschale, rund
Panier à fruits, rond
Cesta fruta, redonda

art.	Ø cm.
41629-17	17,0
41629-20	20,0
41629-25	25,5



NEW

Bread basket, cotton linen
Cesto pane, fodera cotone
Brotkorb, Baumwollfutter
Panier, doublure en coton
Cesta pan, forro de algodón

art.	Ø cm.	h. cm.
42881-24	24	8

Powder coated metal.
Metallo verniciato a polvere.



NEW

Bread basket, cotton linen
Cesto pane, fodera cotone
Brotkorb, Baumwollfutter
Panier, doublure en coton
Cesta pan, forro de algodón

art.	dim. cm.
42881-25	25x20x8

Powder coated metal.
Metallo verniciato a polvere.



NEW

Bread basket, cotton linen
Cesto pane, fodera cotone
Brotkorb, Baumwollfutter
Panier, doublure en coton
Cesta pan, forro de algodón

art.	dim. cm.
42881-26	24x20x8

Powder coated metal.
Metallo verniciato a polvere.



Wire basket, cotton linen
Cesto in filo, fodera cotone
Drahtkorb, Baumwollfutter
Panier métallique, doublure en coton
Cesta de alambre, forro de algodón

art.	dim. cm.
42878-17	17x12,5x8
42878-25	25x15,5x12



Wire basket, cotton linen

Cesto in filo, fodera cotone
Drahtkorb, Baumwollfutter
Panier métallique, doublure en coton
Cesta de alambre, forro de algodón

art.	dim. cm.
42877-17	17x12,5x8
42877-25	25x17x12



Kraft paper bag, washable

Cesto pane di carta kraft lavabile
Kraftpapierbrottasche, waschbar
Panier en papier kraft lavable
Cesta pan de papel kraft lavable

art.	Ø cm.	h. cm.
42879M12	12	12
42879M15	15	10
42879M22	22	13
42879M25	25	18



Kraft paper bag, washable

Cesto pane di carta kraft lavabile
Kraftpapierbrottasche, waschbar
Panier en papier kraft lavable
Cesta pan de papel kraft lavable

art.	Ø cm.	h. cm.
42879K12	12	12
42879K15	15	10
42879K22	22	13
42879K25	25	18



Bread basket

Cesto pane
Brotkorb
Corbeille à pain
Cesta pan

art.	Ø cm.	h. cm.
42948-18	10	7
42948-20	20	7
42948-25	25	7



Bread basket

Cesto pane
Brotkorb
Corbeille à pain
Cesta pan

art.	dim. cm.
42948-23	23x15x6,5



Bread basket

Cesto pane
Brotkorb
Corbeille à pain
Cesta pan

art.	Ø cm.	h. cm.
42935-19	19	9
42935-26	26	9



Bread basket

Cesto pane
Brotkorb
Corbeille à pain
Cesta pan

art.	Ø cm.	h. cm.
42944-23	23	7



Bread basket

Cesto pane
Brotkorb
Corbeille à pain
Cesta pan

art.	dim. cm.
42945-27	27x20x10



Bread basket

Cesto pane
Brotkorb
Corbeille à pain
Cesta pan

art.	dim. cm.
42945-18	18x13x6,5
42945-23	23x15x6,5



Bread basket

Cesto pane
Brotkorb
Corbeille à pain
Cesta pan

art.	Ø cm.	h. cm.	col.
42974B13	13	10	●
42974M13	13	10	●



Canvas bag, round

Cesto cotone, rotondo
Brottasche, rund, Baumwolle
Panier à pain rond, coton
Cesta pan redonda, algodón

art.	Ø cm.	h. cm.	col.
42875-17	17	11	●
42875-20	20	12	●

Cotton, machine-washable up to 30° C.
Cotone, lavabile a macchina fino a 30° C.



Canvas bag, round

Cesto cotone, rotondo
Brottasche, rund, Baumwolle
Panier à pain rond, coton
Cesta pan redonda, algodón

art.	Ø cm.	h. cm.	col.
42875B17	17	11	●
42875B20	20	12	●

Cotton, machine-washable up to 30° C.
Cotone, lavabile a macchina fino a 30° C.



NEW

Canvas bag, round

Cesto cotone, rotondo
Brottasche, rund, Baumwolle
Panier à pain rond, coton
Cesta pan redonda, algodón

art.	Ø cm.	h. cm.	col.
42876-12	12	15	●

Cotton, machine-washable up to 30° C.
Cotone, lavabile a macchina fino a 30° C.



Canvas bag, oval

Cesto cotone, ovale
Brottasche, oval, Baumwolle
Panier à pain ovale, coton
Cesta pan , algodón

art.	dim. cm.	col.
42876-20	20x15x10	●
42876-25	25x18x12	●

Cotton, machine-washable up to 30° C.
Cotone, lavabile a macchina fino a 30° C.



Canvas bag, round

Cesto cotone, rotondo
Brottasche, rund, Baumwolle
Panier à pain, coton
Cesta pan, algodón

art.	Ø cm.	h. cm.	col.
42873-01	19	23	●

Ceramic stone pillow included. Easy to heat up in microwave for 90 sec. at 500 Watt. – Cuscino con sfere ceramica incluso. Scaldare in microonde per 90 secondi a 500 Watt.



Canvas bag, round

Cesto cotone, rotondo
Brottasche, rund, Baumwolle
Panier à pain, coton
Cesta pan, algodón

art.	Ø cm.	h. cm.	col.
42873-02	19	23	●

Ceramic stone pillow included. Easy to heat up in microwave for 90 sec. at 500 Watt. – Cuscino con sfere ceramica incluso. Scaldare in microonde per 90 secondi a 500 Watt.



Bowl, oval

Ciotola ovale
Schüssel, oval
Bassine ovale
Bol oval

art.	dim. cm.
42931-19	19,5x17



Truffle-slicer

Tagliatartufi
Trüffelschneider
Coupe-truffes
Corta trufa

art.	dim. cm.	des.
48237-00	21x8,5	plain
48237-01	21x8,5	serrated



Truffle-slicer

Tagliatartufi
Trüffelschneider
Coupe-truffes
Corta trufa

art.	dim. cm.	des.
48236-00	21x8,5	plain
48236-01	21x8,5	serrated

Rosewood handle. – Manico in palissandro.



Truffle jar

Contentitore tartufi
Trüffel-Verpackung
Réceptif à truffes
Envasado para trufa

art.	Ø cm.	h. cm.
48237-99	6	4,5

For transport and storage, prevents weight loss.
Per trasporto e conservazione, previene il calo di peso.



Truffle server
Servitartufi
Trüffel-Service
Service à truffes
Servidor de trufas

art.	dim. cm.
48237-35	30x20x9

Chesnut wood. – Castagno.



Tray with dome cover
Vassoio con campana
Tablett mit Haube
Plat avec cloche
Bandeja con campana

art.	Ø cm.	h. cm.
41416-18	18,5	24,5

Beech wood tray with glass cover Ø 16 H 22,5 cm. – Vassoio in legno di faggio con coperchio in vetro Ø 16 H 22,5 cm.



Salt/pepper shaker set
Set spargisale/pepe
Salz- und Pfefferstreuer-Set
Set salière et poivrier
Juego salero y pimentero

art.	Ø cm.	h. cm.
42924-02	5	6,5

SS



Condiment set, 2 pcs
Set 2 pz sale e pepe
Menage, 2-teilig
Ménagère, 2 pièces
Servicio de mesa, 2 piezas

art.	dim. cm.	gr.
42927-02	3x3x5	14

Universal holes. – Fori universali.

SS



Salt/pepper shaker, chrome top
Spargisale/pepe cromato
Salz-/Pfefferstreuer, verchromt
Salière/poivrier, chromé
Salero/pimentero, cromado

art.	Ø cm.	h.	gr.
42928-00	4,5	11	57

Universal holes. – Fori universali.



Salt/pepper shaker, set 12 pcs
Spargisale/pepe, set 12 pz
Salz-/Pfefferstreuer, 12 Stk
Salière/poivrier, set 12 pcs
Salero/pimentero, juego 12 pz

art.	Ø cm.	h. cm.
42926-12	3	9

SS



Salt shaker
Spargisale
Salzstreuer
Salière
Salero

art.	Ø cm.	h. cm.
42922-08	8	17

For french fries, cover to screw.
Per patatine fritte, coperchio a vite.

NEW

SS



Condiment set, 2 pcs
Sale e pepe, 2 pezzi
Menage, 2-teilig
Ménagère, 2 pièces
Servicio de mesa, 2 piezas

art.	dim. cm.
42929-01	11,5x5,5x17

Wood base, satin polished handle.
Base legno, manico satinato.

SS



Condiment set, 2 pcs
Servizio oliera, 2 pezzi
Menage, 2-teilig
Ménagère, 2 pièces
Servicio de mesa, 2 piezas

art.	dim. cm.
42929-02	16x7,5x24,5

Wood base, satin polished handle.
Base legno, manico satinato.

SS



SS

Condiment set, 4 pcs

Servizio oliera, 4 pezzi
Menage, 4-teilig
Ménagère, 4 pièces
Servicio de mesa, 4 piezas

art.	dim. cm.
42929-03	15,5x12x24,5

Wood base, satin polished handle.
Base legno, manico satinato.



SS

Oil/vinegar sprayer, 2 pcs

Nebulizzatore olio/aceto, 2 pz
Öl-/Essigsprühflasche, 2 Stück
Nébuliseur huile vinaigre, 2 pièces
Nebulizador aceite/vinagre, 2 pz

art.	Ø cm.	h. cm.	ml.
41635-02	4	18	110



SS

Oil and vinegar stand

Porta olio/aceto
Essig u. Öl-Stand
Porte huile et vinaigre
Soporte para aceite y vinagre

art.	dim. cm.
66362-02	12,5x6x27



SS

Condiment set, 4 pcs

Servizio oliera, 4 pezzi
Menage, 4-teilig
Ménagère, 4 pièces
Servicio de mesa, 4 piezas

art.	dim. cm.
41638-04	17,5x10,5x23



SS

Condiment set, 2 pcs

Servizio oliera, 2 pezzi
Menage, 2-teilig
Ménagère, 2 pièces
Servicio de mesa, 2 piezas

art.	dim. cm.
41638-02	14,5x8,5x23



SS

Condiment set, 2 pcs

Sale e pepe, 2 pezzi
Menage, 2-teilig
Ménagère, 2 pièces
Servicio de mesa, 2 piezas

art.	dim. cm.
41638-12	10,5x6,5x16



SS

Condiment set, 3 pcs

Set sale, pepe, stecchi
Menage, 3-teilig
Ménagère, 3 pièces
Servicio de mesa, 3 piezas

art.	Ø cm.	h. cm.
41638-13	10,5	16



SS

Cheese jar

Formaggiera
Käsedose
Fromagère
Quesera

art.	Ø cm.	h. cm.
41638-01	10,5	7



SS

Cheese shaker
Spargiformaggio
Käsestreuer
Poudreuse à fromage
Colteler de queso

art.	ml.
42921-00	360



PP

Cutlery/breadstick basket
Portaposate/grissini
Besteck-/Salzstangenkorb
Panier à couverts/gressins
Cesta cubiertos/palitos de pan

art.	Ø cm.	h. cm.	-	col.
42584-01	12	15	-	●
42584M01	12	15	NEW	●



PP

Cutlery dispenser
Portaposate
Besteck-Ablage
Panier à couverts
Cesta portacubiertos

art.	dim. cm.	-	col.
42584-02	27x10x4,5	-	●
42584M02	27x10x4,5	NEW	●



PP

Cutlery dispenser
Portaposate
Besteck-Ablage
Panier à couverts
Cesta portacubiertos

art.	dim. cm.	-	col.
42584-04	53x32,5x10	-	●
42584M04	53x32,5x10	NEW	●



PP

Cutlery dispenser
Portaposate
Besteck-Ablage
Panier à couverts
Cesta portacubiertos

art.	dim. cm.	-	col.
42584B05	53x32,5x9	NEW	●
42584-05	53x32,5x9	-	●



PP

Cutlery dispenser
Portaposate
Besteck-Ablage
Panier à couverts
Cesta portacubiertos

art.	dim. cm.	col.
42584-06	26x18x15	●
42584-07	26x18x15	●



W

Table caddy
Portacondimenti
Tisch-Caddy
Caddy de table
Caddy de mesa

art.	Ø cm.	h. cm.
41639-17	17,5	8,5



W

Cutlery dispenser
Portaposate
Besteck-Ablage
Panier à couverts
Cesta portacubiertos

art.	Ø cm.	h. cm.
41639-11	11,5	14



W

Table caddy 4 compartments
Portacondimenti 4 comparti
Tisch-Caddy 4-Fächer
Caddy de table 4 compartiments
Caddy de mesa 4 compartimentos

art.	dim. cm.	col.
41639-30	17x17x10	○
41639-31	17x17x10	●

Compartments/Scomparti 7x7 cm.



W

Table caddy 6 compartments
Portacondimenti 6 comparti
Tisch-Caddy 6-Fächer
Caddy de table 6 compartiments
Caddy de mesa 6 compartimentos

art.	dim. cm.	col.
41639-40	27x17x10	○
41639-41	27x17x10	●
41639-42	27x17x10	●

Compartments/Scomparti 7,5x7,5 cm.



SS

Table-cloth clips, 4 pcs set
Fermatovaglia, set 4 pz
Tischtuch Klammer, 4 Stk
Pincas à nappe, 4 pièces
Pinzas para mantel, 4 piezas

art.
42953-04

For table/Per tavoli h 3 cm.



SS

Napkin holder
Legatovagliolo
Serviettenring
Porteserviette
Servilletero

art.
42955-00



SS

Dome cover

Cloche
Speiseglocke
Cloche
Cubreplatos

art.	Ø cm.	h. cm.
41560-28	29	18



SS

ABS

Pocket crumbler

Raccoglibriciole tascabile
Krümelsammler taschenformat
Ramasse miettes de poche
Recogemigas de bolsillo

art.	dim. cm.
42593-00	14x2,7



SS

Table crumbler

Raccoglibriciole a tubo
Krümelsammler
Ramasse miettes
Pala recogemigas

art.	dim. cm.
41679-23	23,5



Raclette maker, 4 pans

Macchina per raclette, 4 padelle
Raclette Tischgerät, 4 Pfannen
Appareil à raclette, 4 poêlons
Máquina raclette

art.	dim. cm.	W
41318-00	51x10x12	600

Non-stick upper plate for all cooking (vegetables, meats, etc.). – Piastra superiore antiaderente per tutte le cotture (verdure, carne, ecc.).



Raclette maker

Macchina per raclette
Raclette Tischgerät
Appareil à raclette
Máquina raclette

art.	dim. cm.	W
42420-06	44,5x21,5x30	850

Adjustable height. Suitable for cheese size 1/6 to 1/3 of a wheel. In stainless steel and painted steel. – Altezza regolabile. Per da 1/6 a 1/3 di una forma. In acciaio inossidabile e acciaio verniciato.



Raclette maker

Macchina per raclette
Raclette Tischgerät
Appareil à raclette
Máquina raclette

art.	dim. cm.	W
42420-08	46x26,5x40	850

Tiltable cheese holder. Adjustable height. Ideal for 6-8 people, 1/2 shape. Cheese holder in s/s and epoxy painted steel structure. – Porta formaggio inclinabile. Altezza regolabile. Ideale per 6-8 persone, 1/2 forma. Porta formaggio inox e struttura in acciaio verniciato epossidico.



Fondue set, copper

Set fonduta, rame
Fondue-Service, Kupfer
Service à fondue, cuivre
Servicio para fondues, cobre

art.	Ø cm.	h. cm.	lt.
15430-11	16	26	1,45



Cheese fondue set

Set fonduta formaggio
Käsefondue-Service
Service à fondue fromage
Servicio para fondues queso

art.	Ø cm.	h. cm.	lt.
41311-00	20	18	1



SS

Fondue set 13 pcs

Set fonduta 13 pcs
Fondue-Service 13 Stk
Service à fondue 13 pcs
Servicio para fondues 13 pz

art.	Ø cm.	h. cm.	lt.
41312-00	22	23	2,2

**TABLE TOP TAVOLA
SERVING ITEMS COMPLEMENTI**



Dipping forks, 6 pcs

Set forchette, 6 pz
Fonduegabeln, 6 Stk
Curettes à fondue, 6 pièces
Tenedores para fondue, 6 pz

art. l. cm.
15428-06 24



SS

Stand with grill stone

Supporto con pietra ollare
Träger mit Kochstein
Pierre à cuire avec support
Soporte con piedra

art. dim. cm.
41315-02 17x20x12



SS

Table barbecue

Barbecue da tavola
Tischgrillplatte
Barbecue de table
Parrilla de mesa

art. dim. cm.
44227-30 25x38x11,5

Hot plate/Griglia 22x30 cm. Enmelled cast iron and beechwood. – Ghisa smaltata e legno di faggio.



SS

Table barbecue, 1 closed side

Barbecue da tavola, da esterno
Tischgrill, 1 geschlossene Seite
Barbecue de table 1 foyer fermé
Barbaocia de mesa, 1 lado cerrado

art. dim. cm. Kg.
41313-00 33x22x20 7,3

Also for outdoor use. Solid beech board. Can be put in the dishwasher once disassembled.
– Anche per uso all'esterno. Tagliere in faggio massiccio. Può essere lavato in lavastoviglie una volta smontato.



SS

Table barbecue, 2 open sides

Barbecue da tavola, da interno
Tischgrill, 2 offene Seiten
Barbecue de table 2 foyers ouverts
Barbaocia de mesa, 2 lados abiertos

art. dim. cm. Kg.
41314-00 33x22x20 7,3

2 open sides for indoor use. Solid beech board. Can be put in the dishwasher once disassembled. Supplied with 1 steel pan Ø cm 18 and 1 spatula
2 lati aperti per uso interno. Tagliere faggio massiccio. Lavabile in lavastoviglie una volta smontato. Fornito con 1 padella di ferro Ø cm 18 e 1 spatola.



SS

Plate warmer

Rechaud
Speisenwärmer
Chauffe-plats
Calentador de platos

art. Ø cm. h. cm.
41317-20 20 11

Burning time 2 hours with an average flame.
Tempo di combustione 2 ore a fiamma media.



NEW

SS

Plate warmer

Rechaud
Speisenwärmer
Chauffe-plats
Calentador de platos

art. dim. cm.
41569-34 34x13x6



Mussel pot, enamel cast-iron

Cocotte per molluschi, ferro smaltato
Muscheltopf, emaillierts Stahlblech
Casserole coquillage, émaillée
Cacerola para mejillones, esmaltada

art.	Ø cm.	h. cm.	lt.
42414-05	13,5	9,0	0,75
42414-10	18,0	12,0	2,60
42414-15	20,0	13,0	3,30
42414-20	24,0	13,5	5,20

Not suitable for cooking.
Non idonee alla cottura.



Trivet, cork

Sottopentola, sughero
Korkuntersetzer
Sous-plat, liège
Posavastos de corcho

art.	Ø cm.
42413-24	24



Stand with 4 skewers

Supporto con 4 spiedini
Träger mit 4 Fleischspiesen
Support avec 4 brochettes
Soporte con 4 brochetas

art.	Ø cm.	h. cm.
42417-22	22	46



Swing table top waste bin

Portarifiuti da tavola
Tischeimer
Poubelle dé table
Papelera sobremesa, plástico

art.	Ø cm.	h. cm.
42959-13	12	18



Swing table top waste bin

Portarifiuti da tavola
Tischeimer
Poubelle dé table
Papelera sobremesa

art.	Ø cm.	h. cm.
42959-12	12	17



Nut-cracker

Schiaccianoci
Nussknacker
Casse-noix
Cascanueces

art.
48211-00



Nut-cracker

Schiaccianoci
Nussknacker
Casse-noix
Cascanueces

art.	l. cm.
48210-00	15,3



Lobster cracker

Pinza aragosta
Hummerzange
Pince à homard
Pinza bogavante

art.	l. cm.
48239-00	20



Lobster cracker, aluminum

Pinza aragosta, alluminio
Hummerzange, Aluminum
Pince à homard, alu
Pinza bogavante, aluminio

art.	dim. cm.
48240-00	14,5x6,5



Sea urchin cutter

Taglia ricci di mare
Seeigel-Messer
Coupe oursin
Cortador de erizo de mar

art.	dim. cm.
48286-68	6x22



Lobster pick

Stiletto aragosta
Hummergabel
Curette à homard
Tenedor bogavante

art.	l. cm.
48238-00	20



Lobster forks

Forchettine per aragosta
Hummergäbelchen
Curettes à homard
Tenedores bogavante

art.	dim. cm.	U. Pack
41594-18	18	5

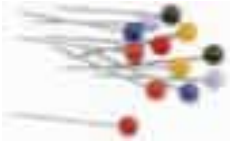

SS

Picks, set 12 pcs

Spilloncini, set 12 pz

Stocher, 12 Stk.

Pic-bigorneaux, set 12 pcs

Pico-caracoles, juego 12 pz

art.

41594-12

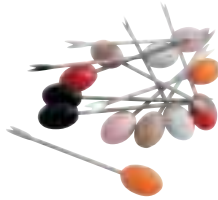

SS

Escargot picks, chromed, set 12 pcs

Forchettine lumache, cromate, set 12 pz

Schneckenabel, verchromed, 12 Stk.

Pic-escargots, chromés, set 12 pcs

Pico-caracoles, cromados, juego 12 pz

art. l. cm.

41686-12 8



PR

Escargot dish

Piatto lumache

Schneckenplatte

Plat à escargots

Plato caracoles

art. Ø cm. cap.

44378-06 19 6



SS

Escargot dish

Piatto lumache

Schneckenplatte

Plat à escargots

Plato caracoles

art. Ø cm. cap.

41687-06 15,5/17,5 6

41687-12 19/22,5 12



SS

Caviar cooler

Coppa caviale

Kaviarkühler

Rafraîchisseur à caviar

Copa caviar

art. Ø cm. h. cm.

41562-18 18 12

Glass bowl Ø 10 cm. – Ciotola vetro Ø 10 cm.



Caviar flatware, mother of pearl

Posate caviale, madreperla

Kaviar-Bestecke, Perlmuttern

Couverts à caviar, nacre

Cuberteria caviar, nácar

art. des. l. cm.

41518-00 spoon 9

41518-01 knife 9

41518-02 fork 9



Seafood display rack, chromed

Supporto acciaio cromato

Unterteil für Austernplatte, verchromt

Support en fil chromé

Soporte cromado para fuente mariscos

art. Ø cm. h. cm.

41593-20 19-25 20



Oyster tray, aluminum

Vassoio frutti di mare, alluminio

Austernplatte, Aluminum

Plat à huîtres, alu

Fuente de mariscos, aluminio

art. Ø cm. h. cm.

41591-32 32 6

41591-36 36 6

41591-40 40 6

41591-45 45 6



SS

Oyster tray

Vassoio frutti di mare

Austernplatte

Plat à huîtres

Fuente de mariscos

art. Ø cm. h. cm.

41592-36 36 4,0

41592-45 45 5,5



SS

Oyster tray

Vassoio frutti di mare

Austernplatte

Plat à huîtres

Fuente de mariscos

art. Ø cm.

41591-90 45-36



SS

Table bag holder

Gancio appendi borsa

Handtaschentischhänger

Crochet de table

Colgador de bolso

art.

41559-04



Wine bucket table clip, chrome
Supporto secchio vino tavola, cromato
Weinkühler-Tischbefestigung, verchromt
Porte-seau à vin, chromé
Soporte de mesa cubo vino, cromado

art.
41558-00

Per/For: 41501-20, 41502-20.



Wine cooler
Secchio vino
Weinkühler
Seau à vin
Cubo vino

art. dim. cm. h. cm.
44946-29 29x19,5 19,5

AY



Bottle cooler
Spumantiera
Flaschenkühler
Rafraichisseur à bouteilles
Cubitera

art. dim. cm. h. cm.
44946-40 40,5x30 25

AY



Wine cooler
Secchio vino
Weinkühler
Seau à vin
Cubo vino

art. Ø cm. h. cm.
44946-20 20 23

AY



Wine cooler
Secchio vino
Weinkühler
Seau à vin
Cubo vino

art. Ø cm. h. cm.
41516-20 20-16 24

SS



Wine cooler
Secchio vino
Weinkühler
Seau à vin
Cubo vino

art. Ø cm. h. cm. col.
41516G20 20-16 24 ●
41516C20 20-16 24 ●

SS



Wine bucket
Secchiello vino
Weinkühler
Seau à vin
Cubo vino

art. Ø cm. h. cm.
41502-20 20-15 20

SS



Wine cooler
Secchiello vino
Weinkühler
Seau à vin
Cubo vino

art. Ø cm. h. cm. bot.
46120-18● 17-12,5 16 1/2
46120-22● 21,5-16 21 1
46120-24● 24-19 22 2

SS



White wine cooler
Secchio vino bianco
Weissweinkühler
Seau à vin blanc
Cubo vino blanco

art. Ø cm. h. cm.
46118-20● 20 25

SS



Wine bucket, aluminum

Secchiello vino, alluminio
Weinkühler, Aluminium
Seau à vin, alu
Cubo vino, alluminio

art.	dim. cm.	lt.	bot.	col.
41507C03	20,5x14x17	2,1	1	●
41507B03	20,5x14x17	2,1	1	●

Hammered surface. – Superficie martellata.



Wine bucket, aluminum

Secchiello vino, alluminio
Weinkühler, Aluminium
Seau à vin, alu
Cubo vino, alluminio

art.	dim. cm.	lt.	bot.	col.
41507C04	25,5x19x20	3,9	1/2	●
41507B04	25,5x19x20	3,9	1/2	●

Hammered surface. – Superficie martellata.



Wine bucket, aluminum

Secchiello vino, alluminio
Weinkühler, Aluminium
Seau à vin, alu
Cubo vino, alluminio

art.	Ø cm.	h. cm.
41501-20	20-15	21



Wine cooler, aluminum

Secchiello vino, alluminio
Weinkühler, Aluminium
Seau à vin, alu
Cubo vino, alluminio

art.	Ø cm.	h. cm.
41501-23	23x20,5	22,5



Wine cooler, aluminum

Secchiello vino, alluminio
Weinkühler, Aluminium
Seau à vin, alu
Cubo vino, alluminio

art.	Ø cm.	h. cm.
41501-40	40,2	25,3

With 6 notches for glasses. – Con 6 fori portacalici.



Wine cooler stand

Colonna portasecchiello
Ständer für Weinkühler
Support seau à champagne
Soporte para cubo

art.	Ø cm.	h. cm.
41505-00	20*	67,6

* Inner diameter. – Diametro interno.



Wine cooler stand

Colonna portasecchiello
Ständer für Weinkühler
Support seau à champagne
Soporte para cubo

art.	Ø cm.	h. cm.
41505-20	20*	70,5

* Inner diameter. – Diametro interno.



Wine cooler stand

Colonna portasecchiello
Ständer für Weinkühler
Support seau à champagne
Soporte para cubo

art.	Ø cm.	h. cm.
41505-17	16*	64
41505-19	20*	64

* Inner diameter. – Diametro interno.



NEW

Wine cooler stand
Colonna portasecchiello
Ständer für Weinkühler
Support seau à champagne
Soporte para cubo

art.	Ø cm.	h. cm.
41505B15	15	71,5

Metal, zinc die-cast. – Metallo, zinco pressofuso.



NEW

Wine cooler, aluminum
Secchio vino, alluminio
Weinkühler, Aluminum
Seau à vin, alu
Cubo vino, aluminio

art.	Ø cm.	h. cm.	lt.
41509B20	15-21,5	22	5

ABS handles. – Maniglie ABS.



SS

Bottle cooler
Glacette termica
Flaschenkühler
Rafraîchisseur à bouteille
Enfriador isotérmico

art.	Ø cm.	h. cm.
41508C12	12/10	20



NEW

Bottle cooler, concrete
Glacette, cemento
Flaschenkühler, Beton
Rafraîchisseur à bouteille, béton
Enfriador, cemento

art.	Ø cm.	h. cm.	-	col.
41504-19	12/10	19	-	●
41504B19	12/10	19	NEW	●



NEW

NEW

Bottle cooler, concrete
Glacette, cemento
Flaschenkühler, Beton
Rafraîchisseur à bouteille, béton
Enfriador, cemento

art.	Ø cm.	h. cm.	col.
41504W20	13/10	19,5	○
41504G20	13/10	19,5	●



SS

Bottle cooler
Glacette termica
Flaschenkühler
Rafraîchisseur à bouteille
Enfriador isotérmico

art.	Ø cm.	h. cm.
41504-09	9,5	22,5



SS

Bottle cooler
Glacette termica
Flaschenkühler
Rafraîchisseur à bouteille
Enfriador isotérmico

art.	Ø cm.	h. cm.
41504-10	10	21



PP

Bottle cooler
Glacette termica
Flaschenkühler
Rafraîchisseur à bouteille
Enfriador isotérmico

art.	Ø cm.	h. cm.
41504-11	10	22



SS

Wine holder

Versavino a molla
Weingestell
Porte-Bouteille
Soporte para botella

art. Ø cm.
41510-08 8



SS

Wine holder

Versavino reversibile
Weingestell
Porte-Bouteille
Soporte para botella

art. l. cm.
46123-00 17



Wine collar, chromed

Collare salvagoccia, cromato
Tropfenfänger, verchromt
Collier anti-gouttes, chromé
Anillo anti-goteo, cromado

art.
41511-00



SS

Wine taster with ring and cord

Tastevin con anello e cordino
Weinprobenschale mit Ring und Schnur
Tastevin avec anneau et cordon
Catador del vino con anillo y cordón

art. Ø cm.
41499-08 8,5



Cognac warmer, palladium

Scaldacognac, palladio
Cognacwärmer, Palladium
Réchaud à cognac, palladium
Calentador brandy, paladio

art. h. cm.
41678-14 14,5



Champagne saber

Sciabola per Sommelier
Champagnersäbel
Sabra à champagne
Sable para Champán

art. l. cm.
41496-40 40



Champagne tongs, chromed

Pinza champagne, cromata
Champagner-Zange, verchromt
Pince à champagne, chromée
Pinza Champaña, cromada

art.
41511-30



SS

Pourer

Versatore
Ausgießer
Verseur
Vertedor

art.
41511-20



Flower vase, nickel plated

Vaso fiori, nichelato
Blumenvase, vernickelt
Vase à fleurs, nickelé
Florero, zinc-niquel

art. Ø cm. h. cm.
42942-16 4 16,5



SS

Flower vase

Vaso fiori
Blumenvase
Vase à fleurs
Florero

art. h. cm.
41628-15 15



NEW



Flower vase

Vaso fiori
Blumenvase
Vase à fleurs
Florero

art. dim. cm. ml.
42942-10 10x4,5x12,5 25



AG

Candelabra 5 lights

Candelabro 5 luci
Kerzenleuchter, 5-flammig
Chandelier, 5 branches
Candelabro, 5 brazos

art. Ø cm. h. cm.
32936-05 13 39

Concrete and glass. – Cemento e vetro.



SS

Candleholder satin finish, set 2 pcs

Portacandela satinato, set 2 pz
Windlicht, mattiert, 2er Set
Bougeoir satin mat, set 2 pcs
Portavela satinado, set 2 pz

art.	Ø cm.	h. cm.
42939-15	5	15



SS

Set 4 tea light candles

Set 4 candele tea light
Kunstteelichter, 4er Set
Set 4 bougies chauffeplat
Set 4 velas de tè

art.	Ø cm.	h. cm.
42446-04	3,65	3,53

Resin. Timer function 5 hours ON/19 OFF. Powered by one CR2450 alkaline battery (not incl.). Working time >50 hours. Flameless moving wick. – Resina. Funzione timer 5 ore ON/19 OFF. 1 batteria alcalina CR2450 (non incl.). Durata > 50 ore. Stoppino mobile senza fiamma.



SS

Set 3 candele

Set 3 candles
Kunstkerzen, 3er Set
Set 3 bougies
Set 3 velas

art.	Ø cm.	h. cm.
42445-03	9	12,5
	9	18,0
	9	23,0

Resin. Timer function 5 hours ON/19 OFF. Powered by 2D alkaline batteries (not incl.). Working time >800 hours. Flameless moving wick. – Resina. Funzione timer 5 ore ON/19 OFF. 2 batterie alcaline D (non incluse). Durata > 800 ore. Stoppino mobile senza fiamma.



Sign holders, chromed

Clip flessibili, cromate
Schildelhalter, verchromt
Porte-étiquettes, chromés
Porta etiquetas con clip, cromate

art.	l. cm.	pcs/pz
41394-02	12	1



SS

Menu stand

Porta menù
Speisekartenhalter
Porte-menu
Portamenús

art.	dim. cm.
42951-08	8x7x2



SS

Table number stand, 4 pcs set

Supporto numero tavola, set 4 pz
Tischnummerständer, Satz 4 Stk
Support numéro de table, set 4 pcs
Soporte número de mesa, set 4 pz

art.	Ø cm.	h. cm.
42954-04	4	10



SS

Table number stand

Supporto numero tavola
Tischnummerständer
Support numéro de table
Soporte número de mesa

art.	Ø cm.	h. cm.
42954-18	7,5	18,5



SS

Card holder

Supporto targhetta
Kartenhalter
Porte-cartes
Portatarjetas

art.	dim. cm.
42952-05	6x5x3



SS

Table sign, 2 pcs set

Targhetta tavola, set 2 pz
Tischaufsteller, Satz 2 Stk
Plaque de table, set 2 pcs
Placa de mesa, set 2 pz

art.	dim. cm.
42951-57	5,5x5x3,5



SS

Table sign, 2 pcs set

Targhetta tavola, set 2 pz
Tischaufsteller, Satz 2 Stk
Plaquette de table, set 2 pcs
Placa de mesa, set 2 pz

art.	dim. cm.
42951-59	5,5x5x3,5



SS

Reception bell

Campanella reception
Rezeptionsklingel
Sonette de réception
Timbre recepción

art.	Ø cm.	h. cm.
41390-00	8,5	6



Table bell

Campanella da tavola
Tischklingel
Sonette de table
Timbre de mesa

art.	Ø cm.	h.
41391-08	8	15,5



W

Newspaper stick

Portagiornale
Zeitungshalter
Canne à journaux
Varilla portaperiodico

art.	l. cm.	col.
48287-18	75	●
48287-19	75	●



SS

Ashtray

Posacenere
Aschenbecher
Cendrier
Cenicero

art.	Ø cm.
48247-10	10



SS

Ashtray

Posacenere
Aschenbecher
Cendrier
Cenicero

art.	Ø cm.	h. cm.
48250-10	10	4,5
48250-12	12	4,5



~~SS~~

Ashtray, chrome plated

Posacenere, cromato
Drehaschenbecher, Metall verchromt
Cendrier, chromé
Cenicero, cromado

art.	Ø cm.	h. cm.
48249-13	13	10,5



NEW
~~SS~~

Ashtray, chrome plated

Posacenere, cromato
Drehaschenbecher, Metall verchromt
Cendrier, chromé
Cenicero, cromado

art.	Ø cm.	h. cm.
48249-10	9,5	11

Glass and metal. – Vetro e metallo.



NEW
~~SS~~

Ashtray, chrome plated

Posacenere, cromato
Aschenbecher, Metall verchromt
Cendrier, chromé
Cenicero, cromado

art.	Ø cm.	h. cm.	col.
48255-01	9,5	8	●
48255-04	9,5	8	○

Glass and metal. – Vetro e metallo.



NEW

SS

~~MF~~

Ashtray with windcover

Posacenere coperchio antivento
Windaschenbecher
Cendrier couvercle anti-vent
Cenicero tapa antiviento

art.	Ø cm.	h. cm.
48249-12	12	5,5



MF

Ashtray, 3 pcs set

Posacenere, set 3 pz
Aschenbecher, 3 Stk
Cendrier, set 3 pièces
Cenicero, 3 pz

art.	Ø cm.	h. cm.	col.
48251-03	8	3	●



MF

Ashtray

Posacenere
Aschenbecher
Cendrier
Cenicero

art.	Ø cm.	h. cm.	col.
48253B09	9,5	4,5	●



MF

Ashtray

Posacenere
Aschenbecher
Cendrier
Cenicero

art.	Ø cm.	h. cm.	col.
48252-10	10	4,0	○
48252-12	12	4,5	○



MF

Ashtray

Posacenere
Aschenbecher
Cendrier
Cenicero

art.	Ø cm.	h. cm.	col.
48252B10	10	4,0	●
48252B12	12	4,5	●

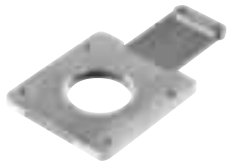

Table cigar cutter

Tagliasigari da tavola
Zigarrenscheider
Coupe-cigares
Guillotina para puros

art.	dim. cm.
48244-07	9x4

Double blad. Assorted models.
Doppia lama. Modelli assortiti.



SS

Table cigar cutter

Tagliasigari da tavola
Zigarrenscheider
Coupe-cigares
Guillotina para puros

art.	dim. cm.
48244-04	4x4



SS

Table cigar cutter

Tagliasigari da tavola
Zigarrenscheider
Coupe-cigares
Guillotina para puros

art.	dim. cm.
48242-09	9x4



SS

Cigar scissors

Forbice sigari
Zigarrenschere
Ciseaux à cigares
Cortador para puros

art.	dim. cm.
48245-10	10x5



SS

Cigar ashtray

Portasigaro con piattino
Aschenbecher mit Zigarrenhalter
Cendrier à cigares
Cenicero para puros

art.	Ø cm.
48241-14	14,5



PMMA

W

Cigar humidor

Vetrina sigari
Zigarren-Vitrine
Vitrine à cigares
Vitrina para puros

art.	dim. cm.
48245-75	30x24x13

With an incorporated hygrometre a small humidifier and liquid. Plexiglass window, cedar wood interior with two removable dividers. Can contain between 50 and 70 cigars according to the cigar ring.

Dotato di igrometro incorporato e un piccolo umidificatore oltre al liquido. Finestra in plexiglass interno di cedro con due divisori removibili. Capienza da 50 a 75 sigari in relazione al ring del sigaro.

PEUGEOT MILLS MACINE



TABLE TOP
TAVOLA



MECHANISMS
MECCANISMI



PEPPER



SALT



WET SEA SALT



LONG PEPPER



CHILI PEPPER



NUTMEG



CINNAMON



FLAX SEED

PEPPER

Made of case-hardened steel for higher, more consistent output with fewer turns. Equipped with a helix-shaped double row of teeth that guide and hold the peppercorns for a perfect grind. The grind is essential for unlocking the full flavour of your pepper. To get the best out of your Peugeot grinding mechanism, we recommend to use peppercorns with a diameter of 6 mm or less. Black, white and dry green peppercorns can be ground in Peugeot pepper mills. The pink berries can be ground only if in a blend (max 15% pink) with one of these peppercorns. Dried coriander is also suitable for the pepper mechanism.

DRY SALT

The Peugeot salt mechanism is designed to grind cooking salt (rock salt). It is made of a special stainless steel that resists corrosion. Its shape is specifically adapted to transform dry salt crystals to a fine powder. To get the best out of your Peugeot salt grinding mechanism, you should use salt with a size of 4 mm max.

WET SEA SALT

For wet sea salt, a specially designed mechanism has been created because the natural consistency and moisture content do not allow the use of an ordinary salt mill. An innovative patented system enables a high-performance grind without blockage even with very humid or compressed salt. This specific mechanism is composed of 3 fins ensuring both resistance and constant output, and of a spiral that mixes the salt and guides it, ensuring a constant flow. Exclusive ceramic mechanism.

NUTMEG

The Peugeot nutmeg mill is equipped with a double stainless steel blade/grater and a strong claw which enables the nutmeg to be very finely ground.

CHILI PEPPER

The chili pepper mechanism is a Peugeot exclusive product. This patented model has a pre-cutting system and a mechanism that grinds dry chili pepper. Like the pepper grinder it has a patented treatment that protects the steel from corrosion while maintaining its sharpness and wear resistance.

PEPE

Realizzato in acciaio, beneficia di un trattamento che lo protegge dalla corrosione, conserva il potere tranciante e lo rende resistente all'usura. Dotato di una doppia fila di denti elicoidali che guidano i grani di pepe verso il basso. Trancia e non schiaccia i grani, per sprigionarne sottilmente sapore e profumo. Consigliamo di utilizzare grani di pepe con un diametro di 6 mm o meno. I grani di pepe neri, bianchi e verdi secchi possono essere macinati nei macinapepe Peugeot. Le bacche rosa possono essere macinate solo se in miscela (max 15% rosa). Il meccanismo del pepe è adatto anche al coriandolo essiccato.

SALE SECCO

Il meccanismo del sale è progettato per macinare il sale da cucina (sale grosso). È fatto di uno speciale acciaio inossidabile resistente alla corrosione. La sua forma è specificamente adattata per trasformare cristalli di sale secco in una polvere fine. Per un risultato ottimale si consiglia di usare sale con una dimensione di 4 mm max.

SALE MARINO UMIDO

Per il sale marino umido, è stato creato un meccanismo apposito. Un innovativo sistema brevettato consente una macinatura ad alte prestazioni senza ostruzioni anche con sale molto umido o compresso. Il meccanismo è composto da 3 alette che ne garantiscono sia la resistenza sia un rendimento costante, e di una spirale che mescola il sale e lo guida assicurandone un flusso costante. Meccanismo esclusivo in ceramica.

NOCE MOSCATA

La macina è dotata di una doppia lama per grattugiare in acciaio inox e di un robusto dischetto uncinato che permette di grattugiare l'intera noce molto finemente.

PEPERONCINO

Questo meccanismo è un prodotto esclusivo Peugeot. Il modello brevettato ha un sistema di pre-taglio e un meccanismo che permettono di macinare il peperoncino essiccato. Come il macinapepe, il meccanismo subisce un trattamento brevettato che protegge l'acciaio dalla corrosione pur mantenendo la sua affilatura e resistenza all'usura.

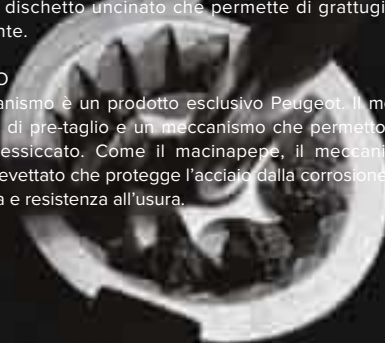



ADJUSTABLE GRINDING SYSTEM

For electric or manual mills.

Patented precision system that enables precise grind adjustment settings. 6 pre-defined levels of grind for pepper and 6 for salt. Rotate the ring at the base of the mill and select one of the positions, each corresponding to a specific grain.

REGOLAZIONE DELLA MACINA

Per macine manuali ed elettriche.

Sistema brevettato che permette una regolazione predefinita della macinatura. 6 Livelli per il pepe e 6 Livelli per il sale. Ruotare l'anello alla base della macina e selezionare una delle posizioni, ognuna corrisponde ad una determinata grana.



CLASSIC ADJUSTABLE SYSTEM

Thumbwheel grind adjustment on electric grinders is found below the grinding mechanism. Grind adjustment nut on manual mills, turn the nut. Clockwise to obtain a finger grind, counter-clockwise to obtain a coarser grind.

REGOLAZIONE CLASSICA

Negli apparecchi elettrici la rotella di regolazione si trova sotto il meccanismo di macinatura. Negli apparecchi manuali la regolazione si effettua ruotando il dado/pomolino. Ruotare in senso orario per ottenere una macinatura più fine, in senso antiorario per ottenere una macinatura più grossa.



PEPPER



SALT





W

PARIS ANTIQUE Pepper/salt mill

Macina pepe/sale
Pfeffer-/Salzmühle
Moulin à poivre/sel
Molinillo pimienta/sal

art.-P art.-S h. cm.

42749P18 42749S18 18

42749P22 42749S22 22

Beech wood antique. – Faggio anticato.



W

PARIS Pepper/salt mill

Macina pepe/sale
Pfeffer-/Salzmühle
Moulin à poivre/sel
Molinillo pimienta/sal

art.-P art.-S h. cm.

42746P12 - 12

42746P18 42746S18 18

42746P22 42746S22 22

42746P30 42746S30 30

Beech wood, chocolate. – Faggio cioccolato.



W

PARIS Pepper/salt mill

Macina pepe/sale
Pfeffer-/Salzmühle
Moulin à poivre/sel
Molinillo pimienta/sal

art.-P art.-S h. cm.

42746P40 - 40

42746P50 - 50

42746P80 - 80

Beech wood, chocolate. – Faggio cioccolato.



W

PARIS Pepper/salt mill

Macina pepe/sale
Pfeffer-/Salzmühle
Moulin à poivre/sel
Molinillo pimienta/sal

art.-P art.-S h. cm.

42747P12 42747S12 12

42747P18 42747S18 18

Beech wood, black lacquered. – Faggio laccato nero.



W

PARIS OLIVE Pepper/salt mill

Macina pepe/sale
Pfeffer-/Salzmühle
Moulin à poivre/sel
Molinillo pimienta/sal

art.-P	art.-S	h. cm.
42718P18	42718S18	18
42718P22	42718S22	22

Olive wood. – Ulivo.



W

SS

SELECT
MOUTURE SUR MESURE

PARIS ICÔNE Pepper/salt mill

Macina pepe/sale
Pfeffer-/Salzmühle
Moulin à poivre/sel
Molinillo pimienta/sal

art.-P	art.-S	h. cm.
42688P18	42688S18	18
42688P22	42688S22	22
42688P30	42688S30	30

Laquered black. – Laccato nero.



NEW

W

SELECT
MOUTURE SUR MESURE

PARIS Pepper/salt mill

Macina pepe/sale
Pfeffer-/Salzmühle
Moulin à poivre/sel
Molinillo pimienta/sal

art.-P	art.-S	h. cm.
42691P12	42691S12	12
42691P18	42691S18	18
42691P22	42691S22	22
42691P30	42691S30	30
42691P40	-	40

Beech wood, black satin. – Faggio, nero satinato.





PARIS Pepper/salt mill

Macina pepe/sale
Pfeffer-/Salzmühle
Moulin à poivre/sel
Molinillo pimienta/sal

art.-P	art.-S	h. cm.
42665P12	42665S12	12
42665P18	42665S18	18
42665P22	42665S22	22
42665P30	42665S30	30
42665P40	42665S40	40

Beech wood, natural. – Faggio naturale.



PARIS Pepper/salt mill

Macina pepe/sale
Pfeffer-/Salzmühle
Moulin à poivre/sel
Molinillo pimienta/sal

art.-P	art.-S	h. cm.
42666P12	42666S12	12
42666P18	42666S18	18
42666P22	42666S22	22
42666P27	42666S27	27
42666P30	42666S30	30
42666P40	42666S40	40

Beech wood, chocolate. – Faggio cioccolato.



PARIS Pepper/salt mill

Macina pepe/sale
Pfeffer-/Salzmühle
Moulin à poivre/sel
Molinillo pimienta/sal

art.-P	art.-S	h. cm.
42694P12	42694S12	12
42694P18	42694S18	18
42694P22	42694S22	22
42694P30	42694S30	30
42694P40	-	40

Beech wood, red passion lacquered.
Faggio laccato red passion.



PARIS GRAPHITE Pepper/salt mill

Macina pepe/sale
Pfeffer-/Salzmühle
Moulin à poivre/sel
Molinillo pimienta/sal

art.-P	art.-S	h. cm.
42721P12	42721S12	12
42721P18	42721S18	18
42721P22	42721S22	22
42721P27	42721S27	27
42721P30	42721S30	30
42721P40	-	40

Beech wood graphite. – Faggio grafite.



PARIS Pepper/salt mill

Macina pepe/sale
Pfeffer-/Salzmühle
Moulin à poivre/sel
Molinillo pimienta/sal

art.-P	art.-S	h. cm.
42667P12	42667S12	12
42667P18	42667S18	18
42667P22	42667S22	22
42667P30	42667S30	30

Beech wood, black lacquered.
Faggio laccato nero.



PARIS Pepper/salt mill

Macina pepe/sale
Pfeffer-/Salzmühle
Moulin à poivre/sel
Molinillo pimienta/sal

art.-P	art.-S	h. cm.
42664P12	42664S12	12
42664P18	42664S18	18
42664P22	42664S22	22
42664P30	42664S30	30
42664P40	-	40

Beech wood, white lacquered.
Faggio laccato bianco.

Paris Ranna

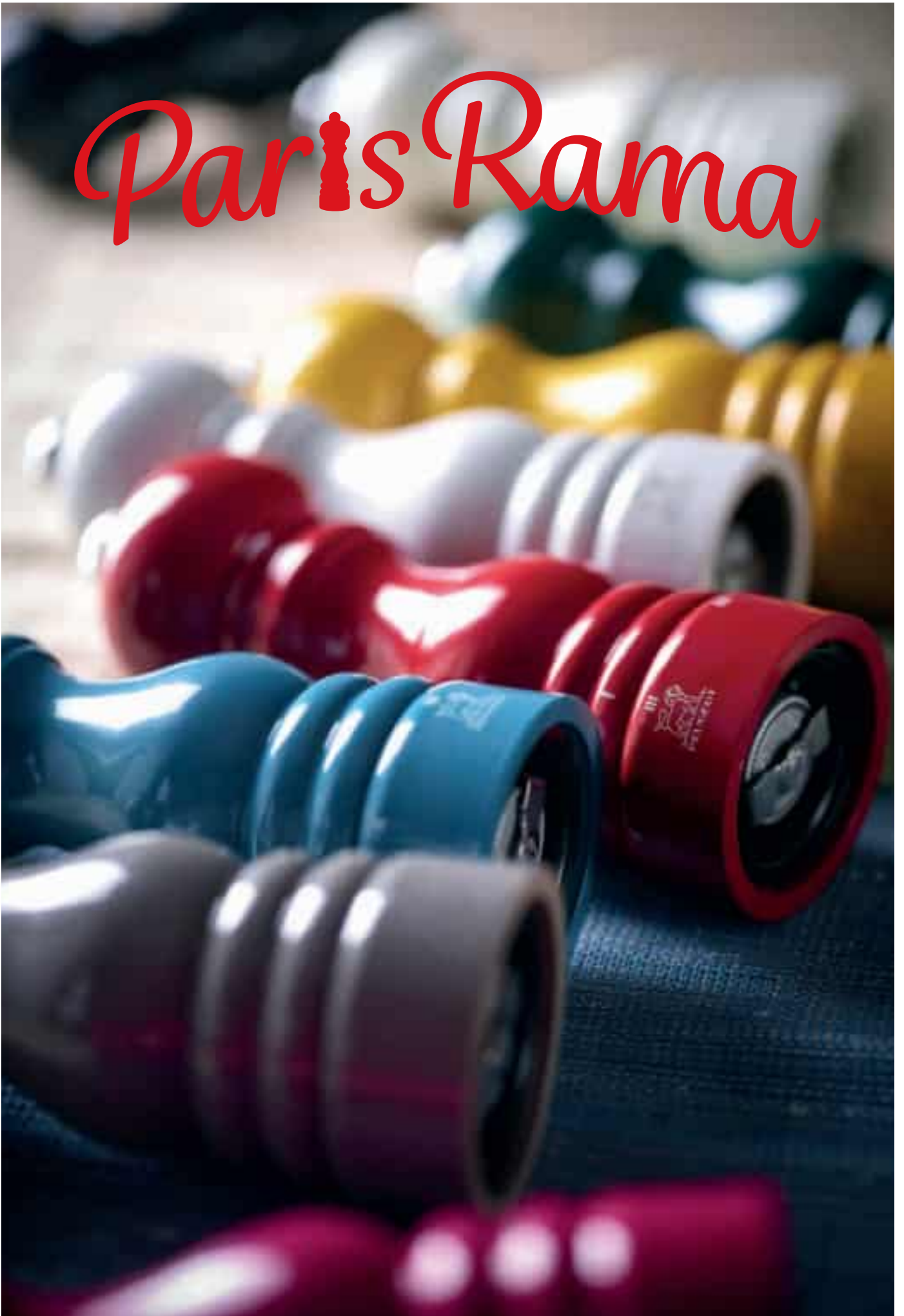



NEW

W

SELECT
MOULIN SUR MESURE

PARISRAMA Pepper/salt mill

Macina pepe/sale
Pfeffer-/Salzmühle
Moulin à poivre/sel
Molinillo pimienta/sal

art.-P art.-S h. cm.
42694P13 42694S13 18

Beech wood, jaune safran lacquered.
Faggio laccato jaune safran.



NEW

W

SELECT
MOULIN SUR MESURE

PARISRAMA Pepper/salt mill

Macina pepe/sale
Pfeffer-/Salzmühle
Moulin à poivre/sel
Molinillo pimienta/sal

art.-P art.-S h. cm.
42694P09 42694S09 18

Beech wood, vert foret lacquered.
Faggio laccato vert foret.



NEW

W

SELECT
MOULIN SUR MESURE

PARISRAMA Pepper mill

Macina pepe
Pfeffermühle
Moulin à poivre
Molinillo pimienta

art. h. cm.
42694P05 18

Beech wood, rose bonbon lacquered.
Faggio laccato rose bonbon.



NEW

W

SELECT
MOULIN SUR MESURE

PARISRAMA Salt mill

Macina sale
Salzmühle
Moulin à sel
Molinillo sal

art. h. cm.
42694S10 18

Beech wood, ivoire lacquered.
Faggio laccato ivoire.



NEW

W

SELECT
MOULIN SUR MESURE

PARISRAMA Salt mill

Macina sale
Salzmühle
Moulin à sel
Molinillo sal

art. h. cm.
42694S07 18

Beech wood, gris perle lacquered.
Faggio laccato gris perle.



NEW

W

SELECT
MOULIN SUR MESURE

PARISRAMA Pepper mill

Macina pepe
Pfeffermühle
Moulin à poivre
Molinillo pimienta

art. h. cm.
42694P11 18

Beech wood, gris taupe lacquered.
Faggio laccato gris taupe.

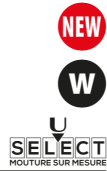

PARISRAMA Pepper/salt mill

Macina pepe/sale
Pfeffer-/Salzmühle
Moulin à poivre/sel
Molinillo pimienta/sal

art.-P art.-S h. cm.
42694P18 42694S18 18

Beech wood, red passion lacquered.
Faggio laccato red passion.



PARISRAMA Pepper mill

Macina pepe
Pfeffermühle
Moulin à poivre
Molinillo pimienta

art. h. cm.
42694P06 18

Beech wood, ardoise lacquered.
Faggio laccato ardoise.



PARISRAMA Pepper mill

Macina pepe
Pfeffermühle
Moulin à poivre
Molinillo pimienta

art. h. cm.
42694P04 18

Beech wood, aubergine lacquered.
Faggio laccato aubergine.



PARISRAMA Pepper/salt mill

Macina pepe/sale
Pfeffer-/Salzmühle
Moulin à poivre/sel
Molinillo pimienta/sal

art.-P art.-S h. cm.
42694P02 42694S02 18

Beech wood, bleu pacifique lacquered.
Faggio laccato bleu pacifique.



NATURE & NATURE BLACK UPCYCLING PROCESS / PROCESSO DI RIUTILIZZO

SORTING
SELEZIONE



DISCARDED WOOD

Knots and differences in grain colour are inherent in the tree's growth and represent the very nature of the wood.

LEGNO SCARTATO

Nodi e differenze di grana di colore sono intrinseche nella crescita dell'albero e rappresentano la vera natura del legno.

BLASTING
SABBIATURA



NEW LEASE OF LIFE

The sandblasting process gives the mills a strong look with their original irregular finish.

NUOVA VITA

Il processo di sabbiatura con la finitura irregolare e originale conferisce alle macine un carattere forte.

VARNISHING
VERNICIATURA



Protection with a solvent-free varnish for everyday use while locking in the wood's natural character.

Una vernice senza solventi rende le macine idonee all'uso quotidiano, pur mantenendo il carattere naturale del legno.

This collection is created from wooden pieces that are discarded at different stages of our manufacturing process (after turning, or after being painted). In order to recycle these pieces and give them a new lease of life, Peugeot carries out a mechanical sandblasting. This is what gives these mills their unusual and irregular texture, endowing them with such a striking organic look. A solvent-free varnish is then applied to protect the wood ensuring its longevity and resistance for lasting daily use. NATURE BLACK comes to life from pieces of wood recycled after painting in the famous chocolate finish. The sandblasting process creates a unique relief that is enhanced by applying a solvent-free matte black paint. The paint together with the texture create an interaction of light with opaque and glossy reflections, instilling its uniqueness in the millstone. A unique play of light, a mix of texture and color.

La collezione NATURE è creata con pezzi di legno che venivano scartati nelle diverse fasi del processo produttivo (dopo la tornitura o dopo la verniciatura). Riprendono ora vita mettendo in mostra le qualità intrinseche del legno. Il processo di sabbiatura con la finitura irregolare e originale conferisce alle macine un carattere forte e dal sorprendente aspetto organico. Ogni pezzo diventa singolare e unico. Una vernice senza solventi protegge il legno garantendone la longevità e la resistenza all'uso quotidiano. NATURE BLACK prende vita da pezzi di legno riutilizzati dopo la verniciatura nella famosa finitura cioccolato. Il processo di sabbiatura crea un rilievo unico che viene esaltato mediante l'applicazione di una vernice nera opaca priva di solventi. La vernice unitamente alla texture, creano un'interazione di luce con riflessi opachi e lucidi instillando nella macina la sua singolarità. Un gioco di luci unico, un mix di texture e colore.



NEW
W

BISTRO NATURE Pepper/salt mill

Macina pepe/sale
Pfeffer-/Salzmühle
Moulin à poivre/sel
Molinillo pimienta/sal

art.-P	art.-S	h. cm.
42627P10	42627S10	10



NEW
W

BISTRO NATURE BLACK Pepper/salt mill

Macina pepe/sale
Pfeffer-/Salzmühle
Moulin à poivre/sel
Molinillo pimienta/sal

art.-P	art.-S	h. cm.
42628P10	42628S10	10



NEW
W

PARIS NATURE Pepper/salt mill

Macina pepe/sale
Pfeffer-/Salzmühle
Moulin à poivre/sel
Molinillo pimienta/sal

art.-P	art.-S	h. cm.
42627P12	42627S12	12
42627P18	42627S18	18
42627P22	42627S22	22
42627P30	42627S30	30
42627P40	-	40



NEW
W

PARIS NATURE BLACK Pepper/salt mill

Macina pepe/sale
Pfeffer-/Salzmühle
Moulin à poivre/sel
Molinillo pimienta/sal

art.-P	art.-S	h. cm.
42628P12	42628S12	12
42628P18	42628S18	18
42628P22	42628S22	22
42628P30	42628S30	30
42628P40	-	40







NEW

SS

SELECT
MOULIN SUR MESURE

PARIS CHEF COPPER Pepper/salt mill

Macina pepe/sale
Pfeffer-/Salzmühle
Moulin à poivre/sel
Molinillo pimienta/sal

art.-P	art.-S	h. cm.
42695P22	42695S22	22

Electroplated copper finish.
Finitura rame elettrolitica.



NEW

SS

SELECT
MOULIN SUR MESURE

PARIS CHEF CARBONE Pepper/salt mill

Macina pepe/sale
Pfeffer-/Salzmühle
Moulin à poivre/sel
Molinillo pimienta/sal

art.-P	art.-S	h. cm.
42696P22	42696S22	22

Special anthracite paint finish.
Verniciatura speciale antracite.



SS

SELECT
MOULIN SUR MESURE

PARIS CHEF Pepper/salt mill

Macina pepe/sale
Pfeffer-/Salzmühle
Moulin à poivre/sel
Molinillo pimienta/sal

art.-P	art.-S	h. cm.
42674P18	42674S18	18
42674P22	42674S22	22
42674P30	42674S30	30



SS

BISTRO CHEF Pepper/salt mill

Macina pepe/sale
Pfeffer-/Salzmühle
Moulin à poivre/sel
Molinillo pimienta/sal

art.-P	art.-S	h. cm.
42624P10	42624S10	10



W

BISTRO Pepper/salt mill

Macina pepe/sale
Pfeffer-/Salzmühle
Moulin à poivre/sel
Molinillo pimienta/sal

art.-P	art.-S	h. cm.
42701-10	42703-10	10

Beech wood, natural. – Faggio naturale.



W

BISTRO Pepper/salt mill

Macina pepe/sale
Pfeffer-/Salzmühle
Moulin à poivre/sel
Molinillo pimienta/sal

art.-P	art.-S	h. cm.
42701P10	42703S10	10

Beech wood, white matt. – Faggio bianco opaco.





W

BISTRO Pepper/salt mill

Macina pepe/sale
Pfeffer-/Salzmühle
Moulin à poivre/sel
Molinillo pimienta/sal

art.-P art.-S h. cm.
42702-10 42704-10 10

Beech wood, chocolate. – Faggio cioccolato.



W

BISTRO Pepper/salt mill

Macina pepe/sale
Pfeffer-/Salzmühle
Moulin à poivre/sel
Molinillo pimienta/sal

art.-P art.-S h. cm.
42702P10 42704S10 10

Beech wood, black matt. – Faggio nero opaco.



W

BISTRO ANTIQUE Pepper/salt mill

Macina pepe/sale
Pfeffer-/Salzmühle
Moulin à poivre/sel
Molinillo pimienta/sal

art.-P art.-S h. cm.
42705P10 42705S10 10

Beech wood antique. – Faggio anticato.



W

BISTRO GRAPHITE Pepper/salt mill

Macina pepe/sale
Pfeffer-/Salzmühle
Moulin à poivre/sel
Molinillo pimienta/sal

art.-P art.-S h. cm.
42713P10 42713S10 10

Beech wood graphite. – Faggio grafite.



W

BISTRO OLIVE Pepper/salt mill

Macina pepe/sale
Pfeffer-/Salzmühle
Moulin à poivre/sel
Molinillo pimienta/sal

art.-P art.-S h. cm.
42714P10 42714S10 10

Olive wood. – Ulivo.



NEW

AY

BISTRO Pepper/salt mill

Macina pepe/sale
Pfeffer-/Salzmühle
Moulin à poivre/sel
Molinillo pimienta/sal

art.-P art.-S h. cm.
42706P10 42706S10 10



W

HOSTELLERIE Pepper mill

Macina pepe
Pfeffermühle
Moulin à poivre
Molinillo pimienta

art. h. cm. col.
42741-22 22 ●
42742-22 22 ●

Natural & chocolate. – Naturale & cioccolato.



W

SS

ROYAN Pepper/salt mill

Macina pepe/sale
Pfeffer-/Salzmühle
Moulin à poivre/sel
Molinillo pimienta/sal

art.-P art.-S h. cm.
42677P14 42677S14 14

Beech wood. Metallic finish that reveals the wood's grains. – Faggio. Finitura metallica che rivela le venature del legno.



TAHITI DUO WATER Pepper/salt mill

Macina pepe/sale
Pfeffer-/Salzmühle
Moulin à poivre/sel
Molinillo pimienta/sal

art. h. cm.
42632-01 15



TAHITI DUO AIR Pepper/salt mill

Macina pepe/sale
Pfeffer-/Salzmühle
Moulin à poivre/sel
Molinillo pimienta/sal

art. h. cm.
42632-02 15



TAHITI DUO FIRE Pepper/salt mill

Macina pepe/sale
Pfeffer-/Salzmühle
Moulin à poivre/sel
Molinillo pimienta/sal

art. h. cm.
42632-03 15



TAHITI DUO EARTH Pepper/salt mill

Macina pepe/sale
Pfeffer-/Salzmühle
Moulin à poivre/sel
Molinillo pimienta/sal

art. h. cm.
42632-04 15



Bistrotoranna





BISTRORAMA Pepper/salt mill

Macina pepe/sale
Pfeffer-/Salzmühle
Moulin à poivre/sel
Molinillo pimienta/sal

art-P	art-S	h. cm.	U. Pack
42630P01	42630S01	10	3

Red passion.



BISTRORAMA Pepper/salt mill

Macina pepe/sale
Pfeffer-/Salzmühle
Moulin à poivre/sel
Molinillo pimienta/sal

art-P	art-S	h. cm.	U. Pack
42630P02	42630S02	10	3

Pacific blue.



BISTRORAMA Pepper/salt mill

Macina pepe/sale
Pfeffer-/Salzmühle
Moulin à poivre/sel
Molinillo pimienta/sal

art-P	art-S	h. cm.	U. Pack
42630P03	42630S03	10	3

Pistachio.



BISTRORAMA Pepper/salt mill

Macina pepe/sale
Pfeffer-/Salzmühle
Moulin à poivre/sel
Molinillo pimienta/sal

art-P	art-S	h. cm.	U. Pack
42630P04	42630S04	10	3

Eggplant.



BISTRORAMA Pepper/salt mill

Macina pepe/sale
Pfeffer-/Salzmühle
Moulin à poivre/sel
Molinillo pimienta/sal

art-P	art-S	h. cm.	U. Pack
42630P05	42630S05	10	3

Candy rose.



BISTRORAMA Pepper/salt mill

Macina pepe/sale
Pfeffer-/Salzmühle
Moulin à poivre/sel
Molinillo pimienta/sal

art-P	art-S	h. cm.	U. Pack
42630P06	42630S06	10	3

Slate lacquer.



BISTRORAMA Pepper/salt mill

Macina pepe/sale
Pfeffer-/Salzmühle
Moulin à poivre/sel
Molinillo pimienta/sal

art-P	art-S	h. cm.	U. Pack
42630P07	42630S07	10	3

Ivory lacquer.





NEW

W

BISTRORAMA Pepper/salt mill

Macina pepe/sale
Pfeffer-/Salzmühle
Moulin à poivre/sel
Molinillo pimienta/sal

art.-P	art.-S	h. cm.	U. Pack
42630P08	42630S08	10	3

Terracotta.



NEW

W

BISTRORAMA Pepper/salt mill

Macina pepe/sale
Pfeffer-/Salzmühle
Moulin à poivre/sel
Molinillo pimienta/sal

art.-P	art.-S	h. cm.	U. Pack
42630P09	42630S09	10	3

Green forest.



NEW

W

BISTRORAMA Pepper/salt mill

Macina pepe/sale
Pfeffer-/Salzmühle
Moulin à poivre/sel
Molinillo pimienta/sal

art.-P	art.-S	h. cm.	U. Pack
42630P10	42630S10	10	3

Pearl grey.



NEW

W

BISTRORAMA Pepper/salt mill

Macina pepe/sale
Pfeffer-/Salzmühle
Moulin à poivre/sel
Molinillo pimienta/sal

art.-P	art.-S	h. cm.	U. Pack
42630P11	42630S11	10	3

Grey.



NEW

W

BISTRORAMA Pepper/salt mill

Macina pepe/sale
Pfeffer-/Salzmühle
Moulin à poivre/sel
Molinillo pimienta/sal

art.-P	art.-S	h. cm.	U. Pack
42630P12	42630S12	10	3

Black lacquer.



NEW

W

BISTRORAMA Pepper/salt mill

Macina pepe/sale
Pfeffer-/Salzmühle
Moulin à poivre/sel
Molinillo pimienta/sal

art.-P	art.-S	h. cm.	U. Pack
42630P13	42630S13	10	3

Yellow saffron.





W
SS

FIDJI GRAPHITE Pepper/salt mill

Macina pepe/sale
Pfeffer-/Salzmühle
Moulin à poivre/sel
Molinillo pimienta/sal

art.-P art.-S h. cm.
42655P15 42655S15 15

Beech wood graphite. – Faggio grafite.



W
SS

FIDJI OLIVE Pepper/salt mill

Macina pepe/sale
Pfeffer-/Salzmühle
Moulin à poivre/sel
Molinillo pimienta/sal

art.-P art.-S h. cm.
42676P15 42676S15 15
42676P20 42676S20 20

Olive wood. – Ulivo.



W
SS

FIDJI Pepper/salt mill

Macina pepe/sale
Pfeffer-/Salzmühle
Moulin à poivre/sel
Molinillo pimienta/sal

art.-P art.-S h. cm.
42767P12 42767S12 12
42767P15 42767S15 15
42767P20 42767S20 20

Beech wood, black matt. – Faggio nero opaco.



NEW

LINE Pepper/salt mill

Macina pepe/sale
Pfeffer-/Salzmühle
Moulin à poivre/sel
Molinillo pimienta/sal

art.-P art.-S h. cm.
42625P12 42625S12 12
42625P18 42625S18 18

**Beech wood and aluminum.
Legno di faggio e alluminio.**



NEW

LINE Pepper/salt mill

Macina pepe/sale
Pfeffer-/Salzmühle
Moulin à poivre/sel
Molinillo pimienta/sal

art.-P art.-S h. cm.
42626P12 42626S12 12
42626P18 42626S18 18

**Beech wood and aluminum.
Legno di faggio e alluminio.**



BALI FONTE Pepper mill

Macina pepe
Pfeffermühle
Moulin à poivre
Molinillo pimienta

art. h. cm. col.
42620P03 8 ●
42620P01 8 ●
42620P02 8 ●

Cast iron. – Ghisa.





NEW

BALI pepper mill/salt dispenser

Macina pepe/Portasale
Pfeffermühle/Salzbehälter
Moulin à poivre/porte-sel
Molinillo pimienta/salero

art.	h. cm.	col.
42620-02	8	●

Cast iron. Bamboo tray. – Ghisa. Vassosio bambù.



NEW

BALI FONTE Pepper mill

Macina pepe
Pfeffermühle/Salzbehälter
Moulin à poivre
Molinillo pimienta

art.	h. cm.	col.
42620P05	8	●



NEW

BALI FONTE Pepper mill

Macina pepe
Pfeffermühle
Moulin à poivre
Molinillo pimienta

art.	h. cm.	col.
42620P06	8	●



W

BAYA Pepper/salt mill

Macina pepe/sale
Pfeffer-/Salzmühle
Moulin à poivre/sel
Molinillo pimienta/sal

art.-P	art.-S	h. cm.
42684P08	42684S08	8

Chocolate & natural. – Cioccolato & naturale.



ABS

AY

BALI Pepper mill

Macina pepe
Pfeffermühle
Moulin à poivre
Molinillo pimienta

art.	h. cm.	col.
42661-03	8	●



ABS

AY

BALI Salt mill

Macina sale
Salzmühle
Moulin à sel
Molinillo sal

art.	h. cm.	col.
42661-06	8	○



AY
SS

SELECT
MOULIN SUR MESURE

DAMAN Pepper/salt mill

Macina pepe/sale
Pfeffer-/Salzmühle
Moulin à poivre/sel
Molinillo pimienta/sal

art.-P	art.-S	h. cm.
42764P16	42764S16	16
42764P21	42764S21	21



W
SS

SELECT
MOULIN SUR MESURE

MADRAS Pepper/salt mill

Macina pepe/sale
Pfeffer-/Salzmühle
Moulin à poivre/sel
Molinillo pimienta/sal

art.-P	art.-S	h. cm.
42705P16	42705S16	16
42705P21	42705S21	21

Beech wood chocolate. – Faggio cioccolato.



W
SS

MADRAS GRAPHITE Pepper/salt mill

Macina pepe/sale
Pfeffer-/Salzmühle
Moulin à poivre/sel
Molinillo pimienta/sal

art.-P	art.-S	h. cm.
42717P16	42717S16	16

Beech wood graphite. – Faggio grafite.



AY

CHAUMONT Pepper/salt mill

Macina pepe/sale
Pfeffer-/Salzmühle
Moulin à poivre/sel
Molinillo pimienta/sal

art.-P	art.-S	h. cm.
42798P11	42798S11	11



AY

VITTEL Pepper/salt mill

Macina pepe/sale
Pfeffer-/Salzmühle
Moulin à poivre/sel
Molinillo pimienta/sal

art.-P	art.-S	h. cm.
42796P16	42796S16	16
42796P23	42796S23	23



AY

NANCY Wet sea salt mill

Macina per sale umido
Mühle für Feuchtes Meersalz
Moulin à sel humide
Molinillo sal húmeda

art.	h. cm.
42728S18	18



AY

NANCY Pepper/salt mill

Macina pepe/sale
Pfeffer-/Salzmühle
Moulin à poivre/sel
Molinillo pimienta/sal

art.-P	art.-S	h. cm.
42727-09	42728-09	9
42727-12	42728-12	12
42727-18	42728-18	18





AY

NANCY Pepper/salt mill

Macina pepe/sale
Pfeffer-/Salzmühle
Moulin à poivre/sel
Molinillo pimienta/sal

art.-P	art.-S	h. cm.
42727-22	42728-22	22
42727-30	42728-30	30
42727-38	42728-38	38



AY

W

OLERON Wet sea salt mill

Macina per sale umido
Mühle für Feuchtes Meersalz
Moulin à sel humide
Molinillo sal húmeda

art.	h. cm.
42670N14	14

Beech wood. – Faggio.



AY

W

OLERON Wet sea salt mill

Macina per sale umido
Mühle für Feuchtes Meersalz
Moulin à sel humide
Molinillo sal húmeda

art.	h. cm.
42670B14	14

Beech wood. – Faggio.



AY

MOLENE Wet sea salt mill

Macina per sale umido
Mühle für Feuchtes Meersalz
Moulin à sel humide
Molinillo sal húmeda

art.	h. cm.
42670W14	14

White. – Bianco.



AY

SS

OSLO Wet sea salt mill

Macina per sale umido
Mühle für Feuchtes Meersalz
Moulin à sel humide
Molinillo sal húmeda

art.	h. cm.
42678W14	14



AY

SS

OSLO Pepper/salt mill

Macina pepe/sale
Pfeffer-/Salzmühle
Moulin à poivre/sel
Molinillo pimienta/sal

art.-P	art.-S	h. cm.
42678P14	42678S14	14



AY

W

OSLO GRAPHITE Pepper/salt mill

Macina pepe/sale
Pfeffer-/Salzmühle
Moulin à poivre/sel
Molinillo pimienta/sal

art.-P	art.-S	h. cm.
42679P12	42679S12	12

Beech wood graphite. – Faggio grafite.





AY
W

OLERON Pepper/salt mill

Macina pepe/sale
Pfeffer-/Salzmühle
Moulin à poivre/sel
Molinillo pimienta/sal

art.-P art.-S h. cm.
42662P14 42662S14 14

Beech wood. – Faggio.



AY
W

OLERON Herbs/chili mill

Macina erbe/peperoncino
Kräuter-/Paprikamühle
Moulin à herbes/piment
Molinillo hierbas/chile

art. h. cm.
42662C14 14

Beech wood. – Faggio.



AY
SS

OUESSANT Pepper/salt mill

Macina pepe/sale
Pfeffer-/Salzmühle
Moulin à poivre/sel
Molinillo pimienta/sal

art.-P art.-S h. cm.
42669P14 42669S14 14



AY
SS

OUESSANT Herbs/chili mill

Macina erbe/peperoncino
Kräuter-/Paprikamühle
Moulin à herbes/piment
Molinillo hierbas/chile

art. h. cm.
42669C14 14



AY
W

OLERON Pepper/salt mill

Macina pepe/sale
Pfeffer-/Salzmühle
Moulin à poivre/sel
Molinillo pimienta/sal

art.-P art.-S h. cm.
42663P14 42663S14 14

Beech wood. – Faggio.



AY
W

OLERON Herbs/chili mill

Macina erbe/peperoncino
Kräuter-/Paprikamühle
Moulin à herbes/piment
Molinillo hierbas/chile

art. h. cm.
42663C14 14

Beech wood. – Faggio.



W

ISEN Nutmeg mill

Macina noce moscata
Muskatmühle
Moulin à mouscade
Molinillo nuez moscada

art. h. cm. col.
42689-15 15 ●
42690-15 15 ●

Natural & black matt. – Naturale & nero opaco.





SS
AY

DAMAN Nutmeg mill
Macina noce moscata
Muskatmühle
Moulin à mouscade
Molinillo nuez moscada

art. h. cm.
42764M15 15

Magnetic stopper. Compartment for 3 nutmegs.
Tappo magnetico. Scompartimento per 3 noci.



W
AY

MADRAS Nutmeg mill
Macina noce moscata
Muskatmühle
Moulin à mouscade
Molinillo nuez moscada

art. h. cm.
42705M15 15

Beech wood chocolate. Magnetic stopper.
Compartment for 3 nutmegs. – Faggio cioccolato.
Tappo magnetico. Scompartimento per 3 noci.



AY
ABS

TIDORE Nutmeg mill
Macina noce moscata
Muskatmühle
Moulin à mouscade
Molinillo nuez moscada

art. h. cm.
42720-01 11

Chromed. Compartment for 7/8 nutmegs.
Cromata. Serbatoio per 7/8 noci.



NEW

SELECT
MOUTURE SUR MESURE

MAESTRO GRAPHITE Pepper mill
Macina pepe
Pfeffermühle
Moulin à poivre
Molinillo pimienta

art.
42621P11



NEW

MAESTRO Set of 3 jars
Set 3 vasetti intercambiabili
Set 3 Gläser
Set 3 réservoirs interchangeables
Juego de 3 tarros

art.
42621P03

Incl. erasable marker.
Incl. pennarello cancellabile.





BBQ Pepper mill

Macina pepe
Pfeffermühle
Moulin à poivre
Molinillo pimienta

art. h. cm.

42631P30 30



PALACE Pepper/salt mill

Macina pepe/sale
Pfeffer-/Salzmühle
Moulin à poivre/sel
Molinillo pimienta/sal

art.-P art.-S h. cm.

42725P10 42725S10 10



MIGNONNETTE Pepper/salt mill

Macina pepe/sale
Pfeffer-/Salzmühle
Moulin à poivre/sel
Molinillo pimienta/sal

art.-P art.-S h. cm.

42723P10 42723S10 10



LANKA Cinnamon shaker/mill

Macina & spargi cannella
Zimt Shaker-/Mühle
Shaker et moulin à cannelle
Especiero y molinillo de canela

art. h. cm.

42685-22 22-7

To grind cinnamon sticks (6 cm max). Shaker and mill function. – Per macinare bastoncini di cannella (max 6 cm). Funzione shaker e macina.





W
SS

ISEN Flax seeds mill

Macina semi lino/sesamo

Leinsamen-Mühle

Moulin à graines de lin

Molino de semillas de lino

art. h. cm.

42680-13 13

Supplied with spoon of 5 g. and brush.

Fornito con un cucchiaino da 5 g. e scovolino.



W
SS

ISEN Long pepper mill

Macina pepe lungo

Langer Pfeffermühle

Moulin à poivres longs

Molinillo de pimienta larga

art. h. cm.

42681-16 16

To grind long pepper and very large peppercorns. Adjustable grinding. Comes with cleaning brush. Also works for cardamom, star anise, tonka beans, cloves, coriander. – Per macinare pepe lungo e grani di pepe molto grandi. Regolabile. Fornito con scovolino. Funziona anche con cardamomo, anice stellato, fave tonka, chiodi di garofano, coriandolo.



NEW
SS
ABS

CIRO Oil & vinegar pourer 9 pcs

Versa olio e aceto, display 9 pz

Öl- und Essigausgießer, 9 Stk

Verseur huile & vinaigre, 9 pcs

Vertedor de aceite y vinagre, 9 pz

art.

42629-09

Fits in most bottles. Neck Ø 17,5-21 mm. Leak-proof system. 4 settings: close, drop, drizzle, continous. Dishwasher safe. – Si adatta alla maggior parte delle bottiglie. Collo Ø 17,5-21 mm. 4 impostazioni: chiuso, goccia, goccioline, flusso continuo. Sistema antigoccia. Lavabile in lavastoviglie.







AY

PC



ALASKA Duo, pepper/salt mill

Duo, macinapepe/sale, elettrici

Duo, Pfeffer-/Salzmühle

Duo, moulin à poivre/sel

Duo, molinillo pimienta/sal

art. h. cm.

42660-02 17



ABS



ZELI Pepper/salt mill

Macina pepe/sale

Pfeffer-/Salzmühle

Moulin à poivre/sel

Molinillo pimienta/sal

art.-P art.-S h. cm.

42801P14 42801S14 14

Stainless steel look. – Imitazione inox.



SS



SELECT
MOUTURE SUR MESURE

ELIS SENSE Pepper/salt mill

Macina pepe/sale

Pfeffer-/Salzmühle

Moulin à poivre/sel

Molinillo pimienta/sal

art.-P art.-S h. cm.

42785S20 42786S20 20

With small dish and spice vial with funnel.
Con vassoietto e fiala dosatrice con imbuto.



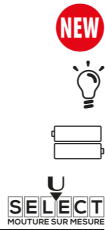

DAMAN Duo, pepper/salt mill
Duo, macinapepe/sale, elettrici
Duo, Pfeffer-/Salzmühle
Duo, moulin à poivre/sel
Duo, molinillo pimienta/sal

art. h. cm.
42763-02 16

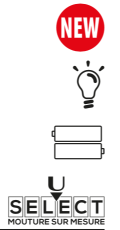

DAMAN
Macina pepe/sale
Pfeffer-/Salzmühle
Moulin à poivre/sel
Molinillo pimienta/sal

art.-P art.-S h. cm.
42763P16 42763S16 16



LINE Duo, pepper/salt mill
Duo, macinapepe/sale, elettrici
Duo, Pfeffer-/Salzmühle
Duo, moulin à poivre/sel
Duo, molinillo pimienta/sal

art. h. cm.
42622-02 15



LINE Pepper/salt mill
Macina pepe/sale
Pfeffer-/Salzmühle
Moulin à poivre/sel
Molinillo pimienta/sal

art.-P art.-S h. cm.
42622P15 42622S15 15

USB - Rechargeable. – Ricaricabile via USB.

USB - Rechargeable. – Ricaricabile via USB.

PEUGEOT APPOLIA



TABLE TOP
TAVOLA



ENAMELLED CERAMIC BAKEWARE CERAMICA SMALTATA DA FORNO



FACILE DA PULIRE

With the range of Appolia vitrified enamel ceramics, Peugeot demonstrates its know-how and expertise in the field of oven dishes.



COLORE E BRILLANTEZZA
DI LUNGA DURATA

It is in France, in the heart of Brittany, in its ceramic factory founded more than 80 years ago, that Peugeot produces Appolia products. The workshop has awarded the EPV label "Entreprise du Patrimoine Vivant" - a sign of recognition by the State that distinguishes French companies with excellent craftsmanship and industrial know-how.



SUPERFICIE ULTRA
LISCIA ANTIABRASIONE

A noble material, Peugeot ceramic guarantees regular and homogeneous cooking for a healthy and tasty cuisine. A well-kept secret, the recipe for ceramic paste, a mix of clay, kaolin and feldspar, gives the product a remarkable resistance to mechanical shocks.

Simple and contemporary lines, Appolia has been designed to offer practicality and express flavors.



Con la gamma di ceramiche smaltate Appolia, Peugeot dimostra il suo know-how e la sua competenza nel campo delle pirofile da forno.

È in Francia, nel cuore della Bretagna, nella sua manifattura di ceramica fondata da più di 80 anni, che Peugeot produce i prodotti Appolia. L'officina è stata premiata con l'etichetta EPV "Entreprise du Patrimoine Vivant" - un segno di riconoscimento da parte dello Stato che distingue le aziende francesi con un'eccellente know-how artigianale e industriale.

Un materiale nobile, la ceramica Peugeot garantisce una cottura regolare e omogenea per una cucina sana e gustosa. Un segreto ben custodito, la ricetta della pasta ceramica, un mix di argilla, caolino e feldspato, conferisce al prodotto una notevole resistenza agli urti meccanici.

Linee pulite e contemporanee, Appolia è stata progettata per offrire praticità ed esprimere i sapori.

Appolia dishes are suitable for use in the oven (250°C), microwave, freezer (-20°C). Dishwasher safe. Produced with 100% natural ingredients (mixture of clays, kaolin, silica, feldspar), 100% recyclable. They guarantee a delicate and tasty, healthy and homogeneous cooking. They have exceptional thermal inertia: they retain heat for up to 30 minutes - they help keep food hot or cold. The material is not porous, does not absorb odors, greases or liquids. The hardness of the final product gives the oven dishes a high mechanical resistance to shocks, scratches and acids. The resistance of Peugeot vitrified enamel has been tested by an independent laboratory. Easy to clean with a simple sponge. Long-lasting color and shine. Comfortable and easy to use, wide and striped handles for a secure grip; rounded corners, facilitate service and cleaning; deep, they offer more volume; allow the retention of cooking juices in order to preserve all the flavors, they are stackable one inside the other to save space. A collection for every day, beautiful, durable and versatile from the kitchen to the table. Available in 6 colors: red, ecru, blue - timeless and essential shades; slate, eggplant, terracotta - contemporary and chic shades.

Le pirofile Appolia sono idonee all'uso in forno (250°C), microonde, congelatore (-20°C). Lavabili in lavastoviglie. Prodotte con ingredienti naturali al 100% (miscela di argille, caolino, silice, feldspato), 100% riciclabili. Garantiscono una cottura delicata e gustosa, sana e omogenea. Hanno eccezionale inerzia termica: trattengono il calore fino a 30 minuti - aiutano a mantenere il cibo caldo o freddo. Il materiale non è poroso, non assorbe odori, grassi o liquidi. La durezza del prodotto finale conferisce alle pirofile un'elevata resistenza meccanica agli urti, graffi e acidi. La resistenza dello smalto vetrificato di Peugeot è stata testata da un laboratorio indipendente. Facile da pulire con una semplice spugna. Colore e brillantezza di lunga durata. Comode e facili da usare, maniglie larghe e striate per una presa sicura; angoli arrotondati, facilitano il servizio e la pulizia; profonde, offrono più volume; consentono la ritenzione dei succhi di cottura in modo da preservare tutti i sapori, sono impilabili l'una nell'altra per un risparmio di spazio. Una collezione per tutti i giorni, bella, durevole e versatile dalla cucina alla tavola. Disponibile in 6 colori: rosso, ecru, blu - tonalità senza tempo ed essenziali; ardesia, melanzana, terracotta - tonalità contemporanee e chic.





Rectangular baker RED

Pirofila rettangolare
Rechteckige Ofenschale
Plat four rectangulaire
Plato horno rectangular

art.	cm. int.	cm. est.	lt.	Kg.
44701R22	18x12x4,5	22x13x5	0,85	0,68
44701R25	20x15,5x5,5	25x16,8x6,2	1,4	0,9
44701R32	26x20x6,5	32x21,7x7,2	2,7	1,7
44701R36	30x22x6,8	36x23,6x7,5	3,8	2,2
44701R40	33x25,7x7,5	40x27,2x8,3	5,2	2,8



Square baker RED

Pirofila quadra
Quadratische Ofenschale
Plat four carré
Plato horno cuadrado

art.	cm. int.	cm. est.	lt.	Kg.
44702R18	13x13x4,5	18x14x5	0,66	0,55
44702R21	16,3x16,3x5,4	21x17,5x6	1,1	0,8
44702R28	22,5x22,5x6,5	28x23,7x7,2	2,7	1,6
44702R36	29,5x29,5x7,5	36x31x8,2	5,4	2,8



Round baker RED

Pirofila tonda
Runde Ofenschale
Plat four rond
Plato horno redondo

art.	Ø cm.	h. cm.	cm. est.	lt.	Kg.
44703R27	23	6	27x23,4x6,7	2,1	1,15
44703R34	30	7	34x29,5x7,7	3,8	2,10



Soufflé dish RED

Pirofila soufflé
Soufflé Ofenschale
Plat four soufflé
Plato horno soufflé

art.	Ø cm.	h. cm.	cm. est.	lt.	Kg.
44704R22	22	8,5	24x21,7x9,7	2,40	1,50

NEW



Oval baker RED

Pirofila ovale
Ovale Ofenschale
Plat four ovale
Plato horno ovalado

art.	cm. int.	cm. est.	lt.	Kg.
44706R31	27x20x6	31x21,5x7	2,2	1,4
44706R40	34,5x25,5x7,5	40x27,2x8,2	4,5	2,4



Tray RED

Vassoio
Tablett
Plateau
Bandeja

art.	cm. int.	cm. est.	lt.	Kg.
44707R40	34,5x16x1,5	40x17,8x2,5	-	1,35

NEW



Round baker RED
Pirofila tonda
Runde Ofenschale
Plat four rond
Plato horno redondo

art.	Ø cm.	h. cm.	cm. est.	lt.	Kg.
44708R28	28	4,5	33x28,3x5,4	2,2	1,5



Round baker RED
Pirofila tonda
Runde Ofenschale
Plat four rond
Plato horno redondo

art.	Ø cm.	h. cm.	cm. est.	lt.	Kg.
44708R30	30	3,5	35x30,5x4,3	2,40	1,60

NEW



Rectangular baker RED
Pirofila rettangolare
Rechteckige Ofenschale
Plat four rectangulaire
Plato horno rectangular

art.	cm. int.	cm. est.	lt.	Kg.
44709R31	26x11x8	31x12,4x8,7	2,00	1,30

NEW



Terrine dish with lid RED
Terrina con coperchio
Terrine mit Deckel
Terrine avec couvercle
Plato horno pan con tapa

art.	cm. int.	cm. est.	lt.	Kg.
44710R20	15,5x9,2x6	20x11x7,5	0,65	0,85

NEW





Rectangular baker TERRACOTTA

Pirofila rettangolare
Rechteckige Ofenschale
Plat four rectangulaire
Plato horno rectangular

art.	cm. int.	cm. est.	lt.	Kg.
44701T25	20x15,5x5,5	25x16,8x6,2	1,4	0,9
44701T32	26x20x6,5	32x21,7x7,2	2,7	1,7
44701T40	33x25,7x7,5	40x27,2x8,3	5,2	2,8

Square baker TERRACOTTA

Pirofila quadra
Quadratische Ofenschale
Plat four carré
Plato horno cuadrado

art.	cm. int.	cm. est.	lt.	Kg.
44702T21	16,3x16,3x5,4	21x17,5x6	1,1	0,8
44702T28	22,5x22,5x6,5	28x23,7x7,2	2,7	1,6
44702T36	29,5x29,5x7,5	36x31x8,2	5,4	2,8





Rectangular baker EGGPLANT

Pirofila rettangolare
Rechteckige Ofenschale
Plat four rectangulaire
Plato horno rectangular

art.	cm. int.	cm. est.	lt.	Kg.
44701M25	20x15,5x5,5	25x16,8x6,2	1,4	0,9
44701M32	26x20x6,5	32x21,7x7,2	2,7	1,7
44701M40	33x25,7x7,5	40x27,2x8,3	5,2	2,8

Square baker EGGPLANT

Pirofila quadra
Quadratische Ofenschale
Plat four carré
Plato horno cuadrado

art.	cm. int.	cm. est.	lt.	Kg.
44702M21	16,3x16,3x5,4	21x17,5x6	1,1	0,8
44702M28	22,5x22,5x6,5	28x23,7x7,2	2,7	1,6
44702M36	29,5x29,5x7,5	36x31x8,2	5,4	2,8





Rectangular baker ECRU

Pirofila rettangolare
Rechteckige Ofenschale
Plat four rectangulaire
Plato horno rectangular

art.	cm. int.	cm. est.	lt.	Kg.
44701C22	18x12x4,5	22x13x5	0,85	0,68
44701C25	20x15,5x5,5	25x16,8x6,2	1,4	0,9
44701C32	26x20x6,5	32x21,7x7,2	2,7	1,7
44701C36	30x22x6,8	36x23,6x7,5	3,8	2,2
44701C40	33x25,7x7,5	40x27,2x8,3	5,2	2,8



Square baker ECRU

Pirofila quadra
Quadratische Ofenschale
Plat four carré
Plato horno cuadrado

art.	cm. int.	cm. est.	lt.	Kg.
44702C18	13x13x4,5	18x14x5	0,66	0,55
44702C21	16,3x16,3x5,4	21x17,5x6	1,1	0,8
44702C28	22,5x22,5x6,5	28x23,7x7,2	2,7	1,6
44702C36	29,5x29,5x7,5	36x31x8,2	5,4	2,8



Round baker ECRU

Pirofila tonda
Runde Ofenschale
Plat four rond
Plato horno redondo

art.	Ø cm.	h. cm.	cm. est.	lt.	Kg.
44703C27	23	6	27x23,4x6,7	2,1	1,15
44703C34	30	7	34x29,5x7,7	3,8	2,10



Soufflé dish ECRU

Pirofila soufflé
Soufflé Ofenschale
Plat four soufflé
Plato horno soufflé

art.	Ø cm.	h. cm.	cm. est.	lt.	Kg.
44704C22	22	8,5	24x21,7x9,7	2,40	1,50

NEW



Oval baker ECRU

Pirofila ovale
Ovale Ofenschale
Plat four ovale
Plato horno ovalado

art.	cm. int.	cm. est.	lt.	Kg.
44706C31	27x20x6	31x21,5x7	2,2	1,4
44706C40	34,5x25,5x7,5	40x27,2x8,2	4,5	2,4



Tray ECRU

Vassoio
Tablett
Plateau
Bandeja

art.	cm. int.	cm. est.	lt.	Kg.
44707C40	34,5x16x1,5	40x17,8x2,5	-	1,35

NEW



NEW

Round baker ECRU

Pirofila tonda
Runde Ofenschale
Plat four rond
Plato horno redondo

art.	Ø cm.	h. cm.	cm. est.	lt.	Kg.
44708C28	28	4,5	33x28,3x5,4	2,2	1,5
44708C30	30	3,5	35x30,5x4,3	2,40	1,60

Rectangular baker ECRU

Pirofila rettangolare
Rechteckige Ofenschale
Plat four rectangulaire
Plato horno rectangular

art.	cm. int.	cm. est.	lt.	Kg.
44709C31	26x11x8	31x12,4x8,7	2,00	1,30



Bread pan with lid ECRU

Stampo pane con coperchio
Brotform mit Deckel
Plaque boulangère multipains a/couv
Plato panadero con tapa

art.	cm. int.	cm. est.	lt.	Kg.
44705C37	31,5x21	37,5x22,7x7,5	-	3,0





Rectangular baker BLUE

Pirofila rettangolare
Rechteckige Ofenschale
Plat four rectangulaire
Plato horno rectangular

art.	cm. int.	cm. est.	lt.	Kg.
44701B25	20x15,5x5,5	25x16,8x6,2	1,4	0,9
44701B32	26x20x6,5	32x21,7x7,2	2,7	1,7
44701B36	30x22x6,8	36x23,6x7,5	3,8	2,2
44701B40	33x25,7x7,5	40x27,2x8,3	5,2	2,8



Square baker BLUE

Pirofila quadra
Quadratische Ofenschale
Plat four carré
Plato horno cuadrado

art.	cm. int.	cm. est.	lt.	Kg.
44702B21	16,3x16,3x5,4	21x17,5x6	1,1	0,8
44702B28	22,5x22,5x6,5	28x23,7x7,2	2,7	1,6
44702B36	29,5x29,5x7,5	36x31x8,2	5,4	2,8



Square baker BLUE

Pirofila tonda
Runde Ofenschale
Plat four rond
Plato horno redondo

art.	Ø cm.	h. cm.	cm. est.	lt.	Kg.
44703B27	23	6	27x23,4x6,7	2,1	1,15
44703B34	30	7	34x29,5x7,7	3,8	2,10



Soufflé dish BLUE

Pirofila soufflé
Soufflé Ofenschale
Plat four soufflé
Plato horno soufflé

art.	Ø cm.	h. cm.	cm. est.	lt.	Kg.
44704B22	22	8,5	24x21,7x9,7	2,40	1,50

NEW



Round baker BLUE

Pirofila tonda
Runde Ofenschale
Plat four rond
Plato horno redondo

art.	Ø cm.	h. cm.	cm. est.	lt.	Kg.
44708B28	28	4,5	33x28,3x5,4	2,2	1,5
44708B30	30	3,5	35x30,5x4,3	2,40	1,60



Rectangular baker BLUE

Pirofila rettangolare
Rechteckige Ofenschale
Plat four rectangulaire
Plato horno rectangular

art.	cm. int.	cm. est.	lt.	Kg.
44709B31	26x11x8	31x12,4x8,7	2,00	1,30

NEW





Rectangular baker SLATE

Pirofila rettangolare
Rechteckige Ofenschale
Plat four rectangulaire
Plato horno rectangular

art.	cm. int.	cm. est.	lt.	Kg.
44701S22	18x12x4,5	22x13x5	0,85	0,68
44701S25	20x15,5x5,5	25x16,8x6,2	1,4	0,9
44701S32	26x20x6,5	32x21,7x7,2	2,7	1,7
44701S36	30x22x6,8	36x23,6x7,5	3,8	2,2
44701S40	33x25,7x7,5	40x27,2x8,3	5,2	2,8



Square baker SLATE

Pirofila quadra
Quadratische Ofenschale
Plat four carré
Plato horno cuadrado

art.	cm. int.	cm. est.	lt.	Kg.
44702S18	13x13x4,5	18x14x5	0,66	0,55
44702S21	16,3x16,3x5,4	21x17,5x6	1,1	0,8
44702S28	22,5x22,5x6,5	28x23,7x7,2	2,7	1,6
44702S36	29,5x29,5x7,5	36x31x8,2	5,4	2,8



Round baker SLATE

Pirofila tonda
Runde Ofenschale
Plat four rond
Plato horno redondo

art.	Ø cm.	h. cm.	cm. est.	lt.	Kg.
44703S27	23	6	27x23,4x6,7	2,1	1,15
44703S34	30	7	34x29,5x7,7	3,8	2,10



Soufflé dish SLATE

Pirofila soufflé
Soufflé Ofenschale
Plat four soufflé
Plato horno soufflé

art.	Ø cm.	h. cm.	cm. est.	lt.	Kg.
44704S22	22	8,5	24x21,7x9,7	2,40	1,50

NEW



Oval baker SLATE

Pirofila ovale
Ovale Ofenschale
Plat four ovale
Plato horno ovalado

art.	cm. int.	cm. est.	lt.	Kg.
44706S31	27x20x6	31x21,5x7	2,2	1,4
44706S40	34,5x25,5x7,5	40x27,2x8,2	4,5	2,4



Tray SLATE

Vassoio
Tablett
Plateau
Bandeja

art.	cm. int.	cm. est.	lt.	Kg.
44707S40	34,5x16x1,5	40x17,8x2,5	-	1,35

NEW



Round baker SLATE

Pirofila tonda
Runde Ofenschale
Plat four rond
Plato horno redondo

art.	Ø cm.	h. cm.	cm. est.	lt.	Kg.
44708S28	28	4,5	33x28,3x5,4	2,2	1,5



NEW

Round baker SLATE

Pirofila tonda
Runde Ofenschale
Plat four rond
Plato horno redondo

art.	Ø cm.	h. cm.	cm. est.	lt.	Kg.
44708S30	30	3,5	35x30,5x4,3	2,40	1,60



NEW

Rectangular baker SLATE

Pirofila rettangolare
Rechteckige Ofenschale
Plat four rectangulaire
Plato horno rectangular

art.	cm. int.	cm. est.	lt.	Kg.
44709S31	26x11x8	31x12,4x8,7	2,00	1,30



NEW

Terrine dish with lid SLATE

Terrina con coperchio
Terrine mit Deckel
Terrine avec couvercle
Plato horno pan con tapa

art.	cm. int.	cm. est.	lt.	Kg.
44710S20	15,5x9,2x6	20x11x7,5	0,65	0,85



INDIVIDUAL PORTIONS - FROM THE KITCHEN TO THE TABLE
LE MONOPORZIONI - DALLA CUCINA SERVINTAVOLA





Pirofila Rettangolare Monoporzione ECRU

Pirofila Rettangolare Monoporzione
Rechteckige Ofenschale 1 Portion
Plat four rectangulaire portion individuelle
Plato horno rectangular porción individual

art.	cm. int.	cm. est.	lt.	Kg.
44701C22	18x12x4,5	22x13x5	0,85	0,68



Pirofila Quadra Monoporzione ECRU

Pirofila Quadra Monoporzione
Quadratische Ofenschale 1 Portion
Plat four carré portion individuelle
Plato horno cuadrado porción individual

art.	cm. int.	cm. est.	lt.	Kg.
44702C18	13x13x4,5	18x14x5	0,66	0,55



Pirofila Rettangolare Monoporzione RED

Pirofila Rettangolare Monoporzione
Rechteckige Ofenschale 1 Portion
Plat four rectangulaire portion individuelle
Plato horno rectangular porción individual

art.	cm. int.	cm. est.	lt.	Kg.
44701R22	18x12x4,5	22x13x5	0,85	0,68



Pirofila Quadra Monoporzione RED

Pirofila Quadra Monoporzione
Quadratische Ofenschale 1 Portion
Plat four carré portion individuelle
Plato horno cuadrado porción individual

art.	cm. int.	cm. est.	lt.	Kg.
44702R18	13x13x4,5	18x14x5	0,66	0,55



Pirofila Rettangolare Monoporzione SLATE

Pirofila Rettangolare Monoporzione
Rechteckige Ofenschale 1 Portion
Plat four rectangulaire portion individuelle
Plato horno rectangular porción individual

art.	cm. int.	cm. est.	lt.	Kg.
44701S22	18x12x4,5	22x13x5	0,85	0,68



Pirofila Quadra Monoporzione SLATE

Pirofila Quadra Monoporzione
Quadratische Ofenschale 1 Portion
Plat four carré portion individuelle
Plato horno cuadrado porción individual

art.	cm. int.	cm. est.	lt.	Kg.
44702S18	13x13x4,5	18x14x5	0,66	0,55



YELLOW SAFFRON - STRONG AND BRIGHT.
GIALLO ZAFFERANO - FORTE E BRILLANTE.



Rectangular baker
Pirofila rettangolare
Rechteckige Ofenschale
Plat four rectangulaire
Plato horno rectangular

art.	cm. int.	cm. est.	lt.	Kg.
44701Y25	20x15,5x5,5	25x16,8x6,2	1,4	0,9
44701Y32	26x20x6,5	32x21,7x7,2	2,7	1,7
44701Y36	30x22x6,8	36x23,6x7,5	3,8	2,2
44701Y40	33x25,7x7,5	40x27,2x8,3	5,2	2,8



Square baker
Pirofila quadra
Quadratische Ofenschale
Plat four carré
Plato horno cuadrado

art.	cm. int.	cm. est.	lt.	Kg.
44702Y21	16,3x16,3x5,4	21x17,5x6	1,1	0,8
44702Y28	22,5x22,5x6,5	28x23,7x7,2	2,7	1,6
44702Y36	29,5x29,5x7,5	36x31x8,2	5,4	2,8

SATIN BLACK - SOBER WITH CHARACTER AND ELEGANCE.
NERO SATINATO - SOBRIO CON CARATTERE ED ELEGANTE.

NEW



Rectangular baker

Pirofila rettangolare
 Rechteckige Ofenschale
 Plat four rectangulaire
 Plato horno rectangular

art.	cm. int.	cm. est.	lt.	Kg.
44701K22	18x12x4,5	22x13x5	0,85	0,68
44701K25	20x15,5x5,5	25x16,8x6,2	1,4	0,9
44701K32	26x20x6,5	32x21,7x7,2	2,7	1,7
44701K36	30x22x6,8	36x23,6x7,5	3,8	2,2
44701K40	33x25,7x7,5	40x27,2x8,3	5,2	2,8

Square baker

Pirofila quadra
 Quadratische Ofenschale
 Plat four carré
 Plato horno cuadrado

art.	cm. int.	cm. est.	lt.	Kg.
44702K18	13x13x4,5	18x14x5	0,66	0,55
44702K21	16,3x16,3x5,4	21x17,5x6	1,1	0,8
44702K28	22,5x22,5x6,5	28x23,7x7,2	2,7	1,6
44702K36	29,5x29,5x7,5	36x31x8,2	5,4	2,8



Big heart dish
Pirofila cuore
Herz Ofenschale
Plat four cœur
Plato corazón

art.	cm. int.	cm. est.	lt.	Kg.	Por.
44711-01	25,1x24,3x5,3	25,8x25x6	1,7	1,35	4-6



Small heart dish, set 2 pcs
Stampo cuore piccolo, set 2 pezzi
Herz-Ofenschale, klein, 2 Stk
Petit plat cœur, set 2 pièces
Plato corazón pequeño, 2 piezas

art.	cm. int.	cm. est.	lt.	Kg.	Por.
44711-02	12,8x12,6x4,1	13,4x13,2x4,7	0,35	0,35	1

STACKABLE RAMEKINS

NEW





Ramekin, set 2 pcs RED
Stampo ramekin, set 2 pezzi
Pastetenform, 2 Stk
Ramequin, set 2 pièces
Molde ramekin, 2 piezas

art.	cm. int.	cm. est.	lt.	Kg.	Por.
44713R02	8,3x8,3x5	11x11x5,6	0,2	0,23	1



Ramekin, set 2 pcs ECRU
Stampo ramekin, set 2 pezzi
Pastetenform, 2 Stk
Ramequin, set 2 pièces
Molde ramekin, 2 piezas

art.	cm. int.	cm. est.	lt.	Kg.	Por.
44713C02	8,3x8,3x5	11x11x5,6	0,2	0,23	1



Ramekin, set 2 pcs SLATE
Stampo ramekin, set 2 pezzi
Pastetenform, 2 Stk
Ramequin, set 2 pièces
Molde ramekin, 2 piezas

art.	cm. int.	cm. est.	lt.	Kg.	Por.
44713S02	8,3x8,3x5	11x11x5,6	0,2	0,23	1



Ramekin, set 2 pcs SATIN BLACK
Stampo ramekin, set 2 pezzi
Pastetenform, 2 Stk
Ramequin, set 2 pièces
Molde ramekin, 2 piezas

art.	cm. int.	cm. est.	lt.	Kg.	Por.
44713K02	8,3x8,3x5	11x11x5,6	0,2	0,23	1

SERIES LIVING

TABLE TOP
TAVOLA



A complete stainless steel line, that is able to join assortment, beauty, strength and functionality. Quality items that can be used in order to set the most charming tables and buffets, but also in order to have a well-equipped kitchen. The easiest way to serve with charm any kind of dishes: from spaghetti to meat, fish, bread, vegetables, cheese and fruit. It is also indicated for tiny preparations such as sweets, olives and pickles. Nothing will unintentionally escape!

Una linea completa capace di coniugare assortimento, bellezza, robustezza e funzionalità, realizzata in acciaio inox. Oggetti di qualità per apparecchiare le tavole ed i buffet più raffinati, ma anche per disporre quotidianamente di una cucina super-attezzata. Il modo più pratico per servire con eleganza e facilità ogni tipo di pietanza dagli spaghetti alla carne, pesce, pane, verdure, formaggi e frutta ma anche piccoli alimenti come dolci, olive e sottaceti. Niente potrà sfuggire inavvertitamente!



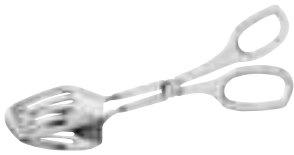

Vegetables serving plier

Forbice per verdure
Salad-/Gemüsezange
Pince à légumes
Pinza verduras

art.	dim. cm.
12550-81	24



Serving plier

Forbice tutto servire
Servierzange
Pince à servir
Pinza servir

art.	dim. cm.
12550-83	21,0
12550-84	26,5
12550-85	24,0



Pie plier

Forbice per torta
Kuchenzange
Pince à tarte
Pinza pasteles

art.	dim. cm.
12550-80	28



Hors-d'oeuvres and pastry plier

Forbice per antipasti e dolci
Vorspeisen-/Pâtisseriezange
Pince à hors-d'oeuvres et pâtisserie
Pinza entremeses y pasteles

art.	dim. cm.
12550-87	15
12550-89	20



Pastry plier

Forbice per dolci
Gebäckzange
Pince à pâtisserie
Pinza pasteles

art.	dim. cm.
12550-88	18



Fruit tongs

Molla per frutta
Fruchtzange
Pince à fruits
Pinza frutas

art.	dim. cm.
12550-50	23,5



Spaghetti tongs

Molla per spaghetti
Spaghettizange
Pince à spaghetti
Pinza espagueti

art.	dim. cm.
12550-73	21
12550-74	30



Toast and pastry tongs

Molla per toast e dolci
Toast-/Gebäckzange
Pince à toast et tarte
Pinza pasteles y tostadas

art.	dim. cm.
12550-77	21
12550-78	24



Multipurpose tongs

Molla universale
Universalzange
Pince universelle
Pinza universal

art.	dim. cm.
12550-58	30



Serving tongs

Molla tutto servire
Servierzange
Pince à servir
Pinza asados y verduras

art.	dim. cm.
12550-68	21
12550-69	26
12550-70	30



Bread and pastry tongs

Molla per pane e pasticceria
Brot-/Gebäckzange
Pince à pain et pâtisserie
Pinza pan y pasteles

art.	dim. cm.
12550-62	18
12550-63	23
12550-64	26



Snail tongs

Molla per lumache
Schneckenzange
Pince à escargots
Pinza caracoles

art. dim. cm.
12550-60 17



Asparagus tongs

Molla per asparagi
Spargelzange
Pince à asperges
Pinza espárragos

art. dim. cm.
12550-66 23



Ice tongs

Molla per ghiaccio
Eiszange
Pince à glace
Pinza hielo

art. dim. cm.
12550-56 17,5



Sugar tongs

Molla per zucchero
Zuckerzange
Pince à sucre
Pinza azúcar

art. dim. cm.
12550-53 12



Sugar tongs

Molla per zucchero
Zuckerzange
Pince à sucre
Pinza azúcar

art. dim. cm.
12550-54 12,5



Ice tongs

Molla per ghiaccio
Eiszange
Pince à glace
Pinza hielo

art. dim. cm.
12550-55 18,5



Panettone knife

Coltello panettone
Tortennmesser
Couteau à gâteau
Cuchillo tarta

art. dim. cm.
12550-34 32



Cake server

Pala torta
Tortenheber
Pelle à gâteau
Pala tarta

art. dim. cm.
12550-02 30



Serving fork

Forchetta a servire
Serviergabel
Fourchette à servir
Tenedor servir

art. dim. cm.
12550-11 29,5
12550-12 26,0



Serving spoon

Cucchiaio a servire
Servierlöffel
Cuiller à servir
Cuchara servir

art. dim. cm.
12550-13 30,0
12550-14 25,5
12550-22 39,0





Serving spoon perforated

Cucchiaio a servire forato
Servierlöffel, perforiert
Cuiller à servir perforée
Cuchara servir, perforada

art.	dim. cm.
12550-25	25,5
12550-26	30,0



Ladle

Mestolo
Mestolo
Schöpfer
Louche
Cazo

art.	dim. cm.
12550-01	25,5



Sauce ladle

Coppino salsa
Coppino salsa
Dressingschöpfer
Louche à sauce
Cazillo salsas

art.	dim. cm.
12550-20	16



Perforated sauce ladle

Coppino forato
Dressingschöpfer, gelocht
Louche à sauce percée
Cazillo, perforado

art.	dim. cm.
12550-21	16,5



Spaghetti serving fork

Forchettone spaghetti
Forchettone spaghetti
Spaghettivorlegegabel
Fourchette à servir spaghetti
Tenedor servir espagueti

art.	dim. cm.
12550-15	28,5



Rice ladle

Cucchiaio risotto
Cucchiaio risotto
Reislöffel
Cuiller à risotto
Cuchara arroz

art.	dim. cm.
12550-16	28



Meat fork

Forchettone
Forchettone
Tranchiergabel
Fourchette
Tenedor

art.	dim. cm.
12550-30	32



Roast beef knife

Coltello arrosto
Coltello arrosto
Tranchiermesser
Couteau à rôtis
Cuchillo roastbeef

art.	dim. cm.
12550-33	32



Salt spoon

Cucchiaio sale
Cucchiaio sale
Salzlöffel
Cuiller à sel
Cucharita para sal

art.	dim. cm.	U. Pack
12550-17	6,5	6



Ice tea spoon

Cucchiaio bibita
Cucchiaio bibita
Limonadenlöffel
Cuillère à soda
Cuchara refresco

art.	dim. cm.	U. Pack
12550-36	19,5	6



Oyster fork

Forchettina ostriche
Forchettina ostriche
Austerngabel
Fourchette à huîtres
Tenedor ostras

art.	dim. cm.	U. Pack
12550-43	14	6



Escargot fork

Forchetta per lumache
Schneckengabel
Fourchette à escargots
Tenedor caracoles

art.	dim. cm.	U. Pack
12550-19	14	6



Ice spoon

Cucchiaio ghiaccio
Eislöffel
Cuillère à glace
Cuchara hielo

art.	dim. cm.
12550-04	22



Dressing spoon

Cucchiaio salsa
Saucenlöffel
Cuillère à sauce
Cuchara salsa

art.	dim. cm.
12550-06	22



Monoportion spoon

Cucchiaio monoporzione
Monoporzion-Löffel
Cuillère monoportion
Cuchara monoporción

art.	dim. cm.	U. Pack
12550-03	9,5	6
12550-07	12,0	6



Monoportion fork

Forchetta monoporzione
Monoporzion-Gabel
Fourchette monoportion
Tenedor monoporción

art.	dim. cm.	U. Pack
12550-05	9,5	6



Monoportion fork

Forchetta monoporzione
Monoporzion-Gabel
Fourchette monoportion
Tenedor monoporción

art.	dim. cm.	U. Pack
12550-09	12	6



DISPLAY & PRESENTATION

BUFFET





MF

Square bowl

Ciotola quadra
Schüssel, quadratisch
Bol carré
Cuenco cuadrado

art.	dim. cm.	col.
44847B09	9x9x4	●
44847B13	12,5x12,5x6,5	●
44847B20	19x19x9	●
44847-09	9x9x4	○
44847-13	12,5x12,5x6,5	○
44847-20	19x19x9	○



MF

Round bowl

Ciotola tonda
Schüssel, rund
Bol ronde
Cuenco redondo

art.	Ø cm.	h. cm.	col.
44846B05	5,5	4,0	●
44846B09	9,0	4,5	●
44846B13	13,0	6,5	●
44846-05	5,5	4,0	○
44846-09	9,0	4,5	○
44846-13	13,0	6,5	○



MF

Party plate

Piattino fingerfood
Fingerfood-Teller
Petit assiette
Platillo

art.	dim. cm.	col.
44844-01	9,5x9,5x1,5	○
44844B01	9,5x9,5x1,5	●





MF

Tray, square

Vassoio quadro
Tablett, quadratisch
Plateau carré
Bandeja, cuadrada

art.	dim. cm.
44841-18	18x18
44841-21	21x21
44841-26	26,5x26,5
44841-37	37x37
44841-51	51x51



MF

Tray, square

Vassoio quadro
Tablett, quadratisch
Plateau carré
Bandeja, cuadrada

art.	dim. cm.
44841B51	51x51



MF

Sushi tray

Vassoio sushi
Sushiplatte
Plateau sushi
Bandeja sushi

art.	dim. cm.
44842B31	31x10,5
44842B53	53x18



MF

Sushi tray

Vassoio sushi
Sushiplatte
Plateau sushi
Bandeja sushi

art.	dim. cm.
44842-31	31x10,5
44842-35	35,5x18
44842-30	30x21
44842-53	53x18



MF

Tray

Vassoio
Tablett
Plateau
Bandeja

art.	dim. cm.	GN
44843-11	53x32,5	1/1
44843-12	32,5x26,5	1/2
44843-24	53x16,2	2/4
44843-13	32,5x17,5	1/3
44843-14	26,5x16,2	1/4



MF

Tray

Vassoio
Tablett
Plateau
Bandeja

art.	dim. cm.	GN
44843B11	53x32,5	1/1
44843B12	32,5x26,5	1/2
44843B24	53x16,2	2/4
44843B13	32,5x17,5	1/3
44843B14	26,5x16,2	1/4



MF

Round dish

Piatto tondo
Platte, rund
Plat rond
Bandeja redonda

art.	Ø cm.
44845-30	30
44845-38	38
44845-41	41
44845-51	51



SAN

Roll-top cover

Coperchio roll-top
Rolltophaube
Couvercle roll-top
Campana roll-top

art.	Ø cm.	h. cm.	fits/per
41447-38	38	20	44846-38



MF

Bowl

Ciotola
Schale
Bol
Cuenco

art.	Ø cm.	h. cm.	ml.
44466-07	7	6	50



MF

Bowl

Ciotola
Schale
Bol
Cuenco

art.	dim. cm.	lt.
44466-11	7,5x7x4,5	0,05



MF

Bowl

Ciotola
Schale
Bol
Cuenco

art.	dim. cm.	lt.
44466-12	11,5x7,5x3	0,06



MF

Bowl

Ciotola
Schale
Bol
Cuenco

art.	dim. cm.	lt.
44466-13	11,5x6x5,5	0,04



MF

Bowl

Ciotola
Schale
Bol
Cuenco

art.	dim. cm.	lt.
44466-14	8,5x7x6	0,07



MF

Bowl

Ciotola
Schale
Bol
Cuenco

art.	dim. cm.	lt.
44466-15	8x8x4	0,1



MF

Bowl

Ciotola
Schale
Bol
Cuenco

art.	dim. cm.	lt.
44466-16	35x4,5x3	0,2



MF

Party spoon

Cucchiaio finger-food
Finger-food-Löffel
Cuiller
Cucharita

art.	dim. cm.	col.
44850-11	11x4,3	○



MF

Party spoon

Cucchiaio finger-food
Finger-food-Löffel
Cuiller
Cucharita

art.	dim. cm.	col.
44850B11	10x4,5	●



MF

Party spoon

Cucchiaio finger-food
Finger-food-Löffel
Cuiller
Cucharita

art.	dim. cm.	col.
44850-13	13,5x4,5	○





MF

Party spoon
Cucchiaio finger-food
Finger-food-Löffel
Cuiller
Cucharita

art.	dim. cm.	col.
44850B13	13,5x4,5	●



MF

Party spoon
Cucchiaio finger-food
Finger-food-Löffel
Cuiller
Cucharita

art.	dim. cm.	col.
44850-12	10x4,5x1	○



MF

Party spoon
Cucchiaio finger-food
Finger-food-Löffel
Cuiller
Cucharita

art.	dim. cm.	col.
44850B12	10x4,5x1	●



MF

Party spoon
Cucchiaio finger-food
Finger-food-Löffel
Cuiller
Cucharita

art.	dim. cm.	col.
44850G12	10x4,5x1	●



MF

Party spoon
Cucchiaio finger-food
Finger-food-Löffel
Cuiller
Cucharita

art.	dim. cm.
44851-01	14,5x4,5



PVD

SS

Party spoon
Cucchiaio gourmet
Gourmet-Löffel
Cuiller gourmet
Cuchara gourmet

art.	dim. cm.	U. Pack	col.
42988-99	13,5x4,5x4,5	6	●
42988C99	13,5x4,5x4,5	6	●
42988G99	13,5x4,5x4,5	6	●



FINE MELAMINE SERIES EASY



Withstands temperatures from -20°C to +70°C.

Termoresistenti da -20°C a +70°C.



Serving board

Tagliere
Servier-Brett
Planche
Tabla

art.	Ø cm.	h. cm.
44470-30	30	1
44470-40	40	1



Platter

Plancia
Tablett
Plateau
Bandeja

art.	dim. cm.	GN
44470-11	53,0x32,5x1	1/1
44470-24	53,0x16,2x1	2/4
44470-12	32,5x26,5x1	1/2
44470-13	32,5x17,5x1	1/3
44470-14	26,5x16,5x1	1/4



Platter

Plancia
Tablett
Plateau
Bandeja

art.	dim. cm.
44470-73	20x10x2
44470-74	30x10x2
44470-75	30x15x2



Bowl

Ciotola
Schüssel
Bol
Bol Ensalada

art.	dim. cm.	lt.
44470-03	19x19x9	1,5
44470-04	25x25x12	3,8



Cake/cheese tray

Piatto torta/formaggi
Kuchen/Käseplatte
Plat gâteau/fromage
Bandeja pasteles/queso

art.	Ø cm.	h. cm.
44470-22	21,5	2,5
44470-31	30,5	3,5
44470-38	37,5	4,0

With non-slip feet. With carved edge fixing the cover. – Con piedini antiscivolo. Con bordo fissa-coperchio.



Dome cover

Campana
Haube
Cloche
Campana

art.	dim. cm.	fits/per
41414-21	21x17	44470-22
41414-31	30x22	44470-31
41414-36	36x27	44470-38



PC



Ciotola
Schüssel
Bol
Cuenco

art.	Ø cm.	h. cm.	lt.
44860-21	21	8,5	1,8
44860-25	25	8,5	2,5
44860-27	27	8,5	3,0

Acacia wood.



Bowl
Ciotola
Schüssel
Bol
Cuenco

art.	Ø cm.	h. cm.	lt.
41446-18	18	9,5	1,0
41446-23	23	12,5	2,2

Concrete. – Cemento.



Bowl
Ciotola
Schüssel
Bol
Cuenco

art.	Ø cm.	h. cm.	lt.
41445-22	22,0	10,5	1,1
41445-26	26,0	13,0	1,7
41445-30	29,5	14,5	2,5

Concrete. – Cemento.





W

Stand

Alzata
Ständer
Support
Soporte

art.	Ø cm.	h. cm.
41445-01	15	10
41445-02	35	15

Acacia wood. – Fig. bowls/ciotole 41445-22/26/30.



W

Stand

Alzata
Ständer
Support
Soporte

art.	Ø cm.	h. cm.
41445-05	20	10,5
41445-06	30,5	15
41445-07	30,5	20

Acacia wood.



PC

Cover

Coperchio
Deckel
Couvercle
Tapa

art.	Ø cm.	h. cm.
41414-31	30	22

Fits to / Per art: 41445-06/07.



W

Stand

Alzata
Ständer
Support
Soporte

art.	dim. cm.
41445-09	53x16,2x20

Acacia wood.



PC

Cover

Coperchio
Deckel
Couvercle
Tapa

art.	dim. cm.	GN
41420-24	53x16,2x10,5	2/4

Fits to /Per art: 41445-09.





W

Buffet stand
Espositore buffet
Buffetgestell
Présentoir
Expositor de buffet

art. dim. cm.
42460-53 53x21x50

Shelves/Ripiani: 30 x 15 - 40 x 17,5 - 53 x 19 cm.



W

Buffet stand
Espositore buffet
Buffetgestell
Présentoir
Expositor de buffet

art. dim. cm.
42470-53 53x21x50

Shelves/Ripiani: 30 x 15 - 40 x 17,5 - 53 x 19 cm.



W
AR

Serving stand 2-tier
Alzata 2 piani
Servierstand 2-stufig
Support 2 niveaux
Soporte 2 pisos

art. dim. cm.
41207-02 25x4,5x34,5

Beech. Slate cm. 31x13 - 41x18.
Faggio. Ardesia cm. 31x13 - 41x18.



W
AR

Serving stand 3-tier
Alzata 3 piani
Servierstand 3-stufig
Support 3 niveaux
Soporte 3 pisos

art. dim. cm.
41207-03 25x4,5x54

Beech. Slate cm. 21x8 - 31x13 - 41x18.
Faggio. Ardesia cm. 21x8 - 31x13 - 41x18.



W

Stand
Alzata
Ständer
Support
Soporte

art. dim. cm.
42463A00 20x20x17,5

Acacia wood.



W

Stand
Alzata
Ständer
Support
Soporte

art. dim. cm.
42463B00 20x20x17,5

Acacia wood.



FE

Stand
Alzata
Ständer
Support
Soporte

art. Ø cm. h. cm.
44840-40 15,5-18 8
44840-41 15,5-18 10
44840-42 15,5-18 18

Black anti-slide coating.
Rivestimento antiscivolo nero.

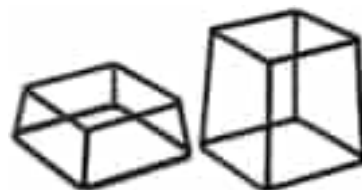

FE

Stand
Alzata
Ständer
Support
Soporte

art. dim. cm.
44840-08 18x18x8
44840-10 18x18x10
44840-18 18x18x18

Black anti-slide coating.
Rivestimento antiscivolo nero.



FE

Stand
Alzata
Ständer
Support
Soporte

art. h. cm.
44840-30 8
44840-31 12
44840-32 18

Black anti-slide coating.
Rivestimento antiscivolo nero.



Stand chromed
Alzata cromata
Ständer, verchromt
Support chromé
Soporte cromado

art.	GN
44840-50	1/1-2/4
44840-51	1/2-1/4
44840-52	1/3-2/3



Stand
Alzata
Ständer
Support
Soporte

art.	GN
44840-55	1/1-2/4
44840-56	1/2-1/4
44840-57	1/3-2/3

Black coating. – Rivestimento nero.



Tray
Vassoio
Tablett
Plateau
Bandeja

art.	dim. cm.	GN
44477-76	53x32,5x3	1/1
44477-77	32,5x26,5x3	1/2
44477-78	32,5x17,6x3	1/3
44477-79	26,5x16,2x3	1/4
44477-80	35,4x32,5x3	2/3
44477-81	53x16,2x3	2/4



Cutting board
Tagliere
Schneidebrett
Planche à découper
Table de corte

art.	dim. cm.
44840-54	35,4x32,5x3,5

Walnut/Noce. Fits stands/Per supporti 44840-52 & 44840-57.



Drawer with black handle
Cassetto con pomolo nero
Schublade, schwarzer Griff
Tiroir poignée noire
Cajón con pomo negro

art.	dim. cm.
44840-58	34x32x17,5

Fits stand 44840-57. – Per supporto 44840-57.



Stand/basket
Alzata/cesto
Ständer/Korb
Support/panier
Soporte/cesta

art.	Ø cm.	h. cm.	col.
44476-52	10,5-8	8	●



Stand/basket
Alzata/cesto
Ständer/Korb
Support/panier
Soporte/cesta

art.	Ø cm.	h. cm.	col.
44476-53	10,5-8	8	●



FE



Stand/basket

Alzata/cesto
Ständer/Korb
Support/panier
Soporte/cesta

art.	Ø cm.	h. cm.	col.
44476-51	10,5-8	8	●



FE

Stand/basket chromed

Alzata/cesto cromato
Ständer/Korb, verchromt
Support/panier, chromé
Soporte/cesta cromado

art.	Ø cm.	h. cm.
44476-30	15	10,5
44476-31	21	20,0



SS

Fruit stand, 3 tiers

Alzata frutta, 3 piani
Obstständer, 3-stöckig
Etagère à fruits, 3 étages
Frutero 3 pisos

art.	Ø cm.	h. cm.
42940-03	32-38-48	50



PMMA

Buffet diplay

Display per buffet
Büffetgestell
Etagère à buffet
Expositor para buffet

art.	dim. cm.
41870-01	54x47x63

Shelves/Ripiani:
47x34 - 37x25 - 27x17 - 23x13 cm.

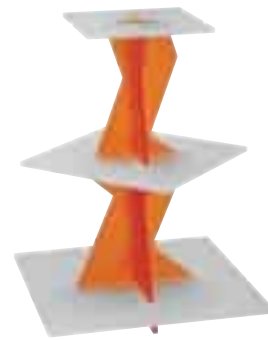

PMMA

Buffet diplay

Display per buffet
Büffetgestell
Etagère à buffet
Expositor para buffet

art.	dim. cm.
41870-02	40x40x53

Shelves/Ripiani:
40x40 - 30x30 - 22x22 - 27x17 - 23x13 cm.



PMMA

Buffet diplay

Display per buffet
Büffetgestell
Etagère à buffet
Expositor para buffet

art.	Ø cm.	h. cm.
41870-03	28	29

Shelves/Ripiani:
38x30x21 - 38x30x13 - 38x30x5 cm.



PMMA

Buffet diplay

Display per buffet
Büffetgestell
Etagère à buffet
Expositor para buffet

art.	dim. cm.
41870-04	40x27x29

Shelves/Ripiani:
40x27x21 - 40x27x13 - 40x27x5 cm.



Wedding cake stand, aluminum

Alzata per torte, alluminio
Hochzeitstortenständer, Aluminium
Support pour tourte de mariage, alu
Pedestal para tartas, aluminio

art.	Ø cm.
47100-03	20-26-32
47100-04	20-26-32-40
47100-05	20-26-32-40-45

Distance between tiers 16,5 cm.

Distanziali h. 16,5 cm.



Wedding cake stand, aluminum

Alzata per torte, alluminio
Hochzeitstortenständer, Aluminium
Support pour tourte de mariage, alu
Pedestal para tartas, aluminio

art.	Ø cm.
47100-06	20-26-32-40-45-50
47100-07	16-20-26-32-40-45-50
47100-08	16-20-26-32-40-45-50-55

Distance between tiers 16,5 cm.

Distanziali h. 16,5 cm.



Lighting column (seafood tray base)

Colonna luminosa (base vassoio frutti mare)
Lichtsäule (Meeresfrüchten-Schale-Basis)
Socle lumineux (à plateau fruit de mer)
Columna luminosa (base bandeja mariscos)

art.	Ø cm.	h. cm.
42979-00	30	21

Stainless steel base plate ø 30 cm., PMMA column, LED-light box and remote control.

Base inox ø cm 30, colonna PMMA, scatola luci-LED con telecomando.



Oyster plate

Piatto frutti di mare
Austernplatte
Plat à huîtres
Fuente de mariscos

art.	Ø cm.	h. cm.
42979-36	36	4,5

The plate has a centering element which keeps it anchored to the column.



Oyster plate

Piatto frutti di mare
Austernplatte
Plat à huîtres
Fuente de mariscos

art.	Ø cm.	h. cm.
42979-45	45	5,5

Sotto il piatto è fissato un elemento di centraggio che lo mantiene ancorato alla colonna luminosa.



Chocolate fountain

Fontana cioccolato
Schokoladenbrunnen
Fontaine à chocolat
Fuente para chocolate

art.	Ø cm.	h. cm.	lt.	W
42982-08	38	80	3,5	370

230V-50Hz-Amps 1,6A. Minimum quantity of chocolate necessary for operation is about 3.5 kg, the maximum is 8 kg. – Quantità minima di cioccolato richiesta per funzionare è di circa 3,5 kg e può contenerne fino a 8 kg.



Cocktail fountain

Fontana cocktails
Cocktails-Laufbrunnen
Fontaine à cocktails
Fuente cocktail

art.	Ø cm.	h. cm.	lt.
42981-73	42	56	15

10W 220V. NOT recommend for use with fizzy drinks or champagne. – Prodotto NON consigliato per liquidi gasati o champagne.



SS

SS



SS

Punch bowl

Coppa punch
Punchbowle
Rafraîchisseur

Cubitera para champán

art.	Ø cm.	lt.
11956-37	36	9,5
11956-42	42	15,0



PC

Punch bowl

Coppa punch
Punchbowle
Rafraîchisseur

Cubitera para champán

art.	Ø cm.	lt.
41541-44	44	15

Stainless steel bottom ring. – Piede inox.



AY

Bottle cooler

Spumantiera
Flaschenkühler
Rafraîchisseur à bouteilles
Cubitera

art.	dim. cm.
44946-40	40,5x30x25



AY

Party tub

Secchio portabottiglie
Flaschenkühler-Bowle
Rafraîchisseur à bouteilles
Cubitera enfriador de botellas

art.	dim. cm.
44946-04	40x28x23



AY

Party tub

Secchio portabottiglie
Flaschenkühler-Bowle
Rafraîchisseur à bouteilles
Cubitera enfriador de botellas

art.	dim. cm.
44946B05	35x35x20



NEW



Party tub metal look

Secchio portabottiglie
Flaschenkühler-Bowle
Rafraîchisseur à bouteilles
Cubitera enfriador de botellas

art.	dim. cm.	lt.
41506-11	40x28x22	11

Galvanized metal with PVC insert.
Metallo galvanizzato con inserto PVC.



NEW



Party tub black metal look

Secchio portabottiglie
Flaschenkühler-Bowle
Rafraîchisseur à bouteilles
Cubitera enfriador de botellas

art.	dim. cm.	lt.
41506B11	40x28x22	11

Galvanized metal with PVC insert.
Metallo galvanizzato con inserto PVC.



NEW



Party tub copper look

Secchio portabottiglie
Flaschenkühler-Bowle
Rafraîchisseur à bouteilles
Cubitera enfriador de botellas

art.	dim. cm.	lt.
41506C11	40x28x22	11

Galvanized metal with PVC insert.
Metallo galvanizzato con inserto PVC.

STAINLESS STEEL TRAYS
VASSOI INOX





Tray, oval
Vassoio ovale
Tablett, oval
Plateau ovale
Bandeja oval

art.	dim. cm.
66325-30	30x19
66325-35	35x22
66325-41	41x26
66325-46	46x29
66325-54	54x37
66325-85	85x58
66325-99	100x68



Tray, rectangular
Vassoio rettangolare
Serviertablett, rechteckig
Plateau rectangulaire
Bandeja rectangular

art.	dim. cm.
66320-28	28x20
66320-35	35x30
66320-40	40x26
66320-50	50x38
66320-65	65x50
66320-85	85x50
66320-99	100x50



Tray, rectangular
Vassoio rettangolare
Serviertablett, rechteckig
Plateau rectangulaire
Bandeja rectangular

art.	dim. cm.
66324-40	40x26
66324-50	50x38
66324-65	65x50
66324-85	85x50
66324-99	100x50



Tray, oval
Vassoio ovale
Tablett, oval
Plateau ovale
Bandeja oval

art.	dim. cm.
41651-20	20x14
41651-25	25x18
41651-30	30x22
41651-35	35x22
41651-40	40x26



Tray, oval
Vassoio ovale
Tablett, oval
Plateau ovale
Bandeja oval

art.	dim. cm.
41651-45	45x29
41651-50	50x35
41651-55	55x38
41651-60	60x42
41651-65	65x45



Tray, round
Vassoio tondo
Tablett, rund
Plateau rond
Bandeja redonda

art.	Ø cm.
66326-30	30
66326-35	35
66326-40	40
66326-60	60
66326-80	80



Fish tray
Vassoio pesce
Fischplatte
Plat à poisson
Salmonera

art.	dim. cm.
66345-55	55x23
66345-65	65x27
66345-74	74x29



Fish tray
Vassoio pesce
Fischplatte
Plat à poisson
Salmonera

art.	dim. cm.
41654-80	80x31
41654-99	100x35



Tray
Vassoio
Tablett
Plateau
Bandeja

art.	dim. cm.	GN
41436-11	53x32,5	1/1
41436-12	32,5x26,5	1/2





Tray
Vassoio
Tablett
Plateau
Bandeja

art. dim. cm. GN
41430-11 53x32,5x5 1/1

Chrome plated handles. Useful height 4 cm.
Maniglie cromate. Altezza utile 4 cm.

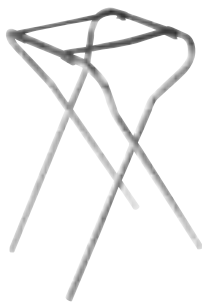

Tray stand, chromed
Stand per vassoi, cromato
Tablett-Träger, verchromt
Porte plateaux, chromé
Soporte para bandejas, cromado

art. dim. cm.
44093-00 38x 48x74



W

Tray stand
Stand per vassoi
Tablett-Träger
Porte plateaux
Soporte para bandejas

art. dim. cm.
44093-01 42x43x82



NEW

PP

Non-slip tray, round
Vassoio antiscivolo, rotondo
Tablett, rutschfest, rund
Plateau antidérapant, rond
Bandeja antideslizante, redonda

art. Ø cm.
41863-35 35



NEW

PP

Non-slip tray, oval
Vassoio antiscivolo, ovale
Tablett, rutschfest, oval
Plateau antidérapant, ovale
Bandeja antideslizante, oval

art. dim. cm.
41864-56 56x68



NEW

PP

Non-slip tray, rectangular
Vassoio antiscivolo, rettangolare
Tablett, rutschfest, rechteckig
Plateau antidérapant, rectangulaire
Bandeja antideslizante, rectangular

art. dim. cm.
41865-40 41x56,5



ACRYLIC MIRRORS
SPECCHI ACRILICI PMMA



Mirror, square

Specchio quadrato
Spiegel, quadratisch
Miroir carré
Espejo cuadrado

art.	dim. cm.
41885-40	40x40
41885-45	45x45
41885-50	50x50
41885-60	60x60



Mirror, oval

Specchio ovale
Spiegel, oval
Miroir ovale
Espejo oval

art.	dim. cm.
41877-45	45x30
41877-61	61x45,5
41877-81	81x61
41877-99	100x70



Mirror, rectangular

Specchio rettangolare
Spiegel, rechteckig
Miroir rectangulaire
Espejo rectangular

art.	dim. cm.
41878-45	45x30
41878-61	61x46
41878-81	81x58,5
41878-99	100x70



Mirror, octagon

Specchio ottagonono
Spiegel, achteckig
Miroir octogonal
Espejo octogonal

art.	Ø cm.
41879-30	30
41879-40	40
41879-50	50
41879-61	61



Mirror, hexagon

Specchio esagono
Spiegel, Sechseck
Miroir hexagon
Espejo hexágono

art.	Ø cm.
41880-38	38
41880-61	61



Mirror, comma

Specchio virgola
Spiegel, Komma
Miroir virgule
Espejo vírgula

art.	Ø cm.
41875-40	40,6
41875-61	61,0



Mirror, segment

Specchio spicchio
Spiegel, Segment
Miroir quartier
Espejo segmento

art.	Ø cm.
41881-30	30,5
41881-40	40,5



Mirror, circle

Specchio cerchio
Spiegel, Kreis
Miroir cercle
Espejo aro

art.	Ø cm.
41876-30	30,5
41876-38	38,0
41876-45	45,0
41876-58	58,0



Mirror, cube

Specchio cubo
Spiegel, Würfel
Miroir cube
Espejo cubo

art.	dim. cm.
41882-15	15x15x15
41882-20	20x20x20
41882-25	25x25x25
41882-30	30x30x30

POLYPROPYLENE BASKETS
CESTI IN POLIPROPILENE SERIE ELITE



Bread basket

Cesto pane
Brotkorb
Corbeille à pain
Cesta pan

art.	dim. cm.	GN	col.
42967-03	53x32,5x6,5	1/1	●
42967-04	32,5x26,5x6,5	1/2	●
42967-05	32,5x17,5x6,5	1/3	●
42967-06	26,4x16,2x6,5	1/4	●
42967-07	17,6x16,2x6,5	1/6	●
42967-08	32,5x35,4x6,5	2/3	●



Bread basket

Cesto pane
Brotkorb
Corbeille à pain
Cesta pan

art.	dim. cm.	GN	col.
42967-13	53x32,5x10	1/1	●
42967-14	32,5x26,5x10	1/2	●
42967-15	32,5x17,5x10	1/3	●
42967-16	26,4x16,2x10	1/4	●
42967-17	17,6x16,2x10	1/6	●
42967-18	32,5x35,4x10	2/3	●



Bread basket

Cesto pane
Brotkorb
Corbeille à pain
Cesta pan

art.	dim. cm.	GN	col.
42967-63	53x32,5x6,5	1/1	●
42967-64	32,5x26,5x6,5	1/2	●
42967-65	32,5x17,5x6,5	1/3	●
42967-66	26,4x16,2x6,5	1/4	●
42967-67	17,6x16,2x6,5	1/6	●
42967-68	32,5x35,4x6,5	2/3	●



Bread basket

Cesto pane
Brotkorb
Corbeille à pain
Cesta pan

art.	dim. cm.	GN	col.
42967-73	53x32,5x10	1/1	●
42967-74	32,5x26,5x10	1/2	●
42967-75	32,5x17,5x10	1/3	●
42967-76	26,4x16,2x10	1/4	●
42967-77	17,6x16,2x10	1/6	●
42967-78	32,5x35,4x10	2/3	●





Bread basket

Cesto pane
Brot-Korb
Corbeille à pain
Cesta pan

art.	dim. cm.	h. cm.	col.
42973-45	45x40	16/27	●



Bread basket

Cesto pane
Brot-Korb
Corbeille à pain
Cesta pan

art.	dim. cm.	h. cm.	col.
42973-60	60x40	16/27	●

With removable divider. – Con divisorio mobile.



Bread basket

Cesto pane
Brot-Korb
Corbeille à pain
Cesta pan

art.	dim. cm.	h. cm.	col.
42973-30	30x40	16/27	●



French stick bread basket

Cesta baguettes
Brotkorb für Baguette
Corbeille à baguettes
Cesta pan francés

art.	Ø cm.	h. cm.	col.
42967-35	35	25/42	●



French stick bread basket

Cesta baguettes
Brotkorb für Baguette
Corbeille à baguettes
Cesta pan francés

art.	Ø cm.	h. cm.	col.
42972-28	30	38	●



Bread basket

Cesto pane
Brotkorb
Corbeille à pain
Cesta pan

art.	dim. cm.	col.
42972-01	40x20x5	●
42972-02	40x30x5	●
42972-03	60x20x5	●
42972-04	60x40x5	●



Bread basket

Cesto pane
Brotkorb
Corbeille à pain
Cesta pan

art.	Ø cm.	h. cm.	-	col.
42968-42	42	12	-	●
42968M42	42	12	NEW	●



Bread basket GN 1/1

Cesto pane
Brotkorb
Corbeille à pain
Cesta pan

art.	dim. cm.	-	col.
42967-53	53x32,5x15,5	-	●
42967M53	53x32,5x15,5	NEW	●



Bread basket

Cesto pane
Brotkorb
Corbeille à pain
Cesta pan

art.	Ø cm.	h. cm.	-	col.
42969-31	31/37	6/12	-	●
42969M31	31/37	6/12	NEW	●



Bread basket

Cesto pane
Brotkorb
Corbeille à pain
Cesta pan

art.	dim. cm.	h. cm.	-	col.
42967-43	45x42	17/24	-	●
42967M43	45x42	17/24	NEW	●



Bread basket

Cesto pane
Brotkorb
Corbeille à pain
Cesta pan

art.	dim. cm.	col.
42993-40	40X30X10	●
42993M40	40X30X10	●



Bread basket

Cesto pane
Brotkorb
Corbeille à pain
Cesta pan

art.	dim. cm.	col.
42991-25	25x19X6,5	●
42991M25	25x19X6,5	●



Bread basket

Cesto pane
Brotkorb
Corbeille à pain
Cesta pan

art.	dim. cm.	col.
42991-32	32x23X7	●
42991M32	32x23X7	●



Bread basket

Cesto pane
Brotkorb
Corbeille à pain
Cesta pan

art.	Ø cm.	h. cm.	col.
42990-16	16	8	●
42990M16	16	8	●



Bread basket

Cesto pane
Brotkorb
Corbeille à pain
Cesta pan

art.	Ø cm.	h. cm.	col.
42990-20	20	8	●
42990M20	20	8	●



Bread basket

Cesto pane
Brotkorb
Corbeille à pain
Cesta pan

art.	Ø cm.	h. cm.	col.
42990-29	29	7	●
42990M29	29	7	●



Bread basket

Cesto pane
Brotkorb
Corbeille à pain
Cesta pan

art.	Ø cm.	h. cm.	col.
42974M13	13	10	●
42974B13	13	10	●



Egg basket

Cesto uova
Eier-Korb
Panier à oeufs
Cesta para huevos

art.	Ø cm.	h. cm.	-	col.
42949B26	26	17	NEW	●
42949-26	26	17	-	●

Fabric lining. For around 20 eggs.
Fodera in tessuto. Per circa 20 uova.



Cutlery dispenser

Portaposate
Besteck-Ablage
Panier à couverts
Cesta portacubiertos

art.	dim. cm.	-	col.
42584B05	53x32,5x9	NEW	●
42584-05	53x32,5x9	-	●



Cutlery dispenser

Portaposate
Besteck-Ablage
Panier à couverts
Cesta portacubiertos

art.	dim. cm.	-	col.
42584-04	53x32,5x10	-	●
42584M04	53x32,5x10	NEW	●



Cutlery dispenser

Portaposate
Besteck-Ablage
Panier à couverts
Cesta portacubiertos

art.	dim. cm.	col.
42584-07	26x18x15	●
42584-06	26x18x15	●





Cutlery dispenser
Portaposate
Besteck-Ablage
Panier à couverts
Cesta portacubiertos

art.	dim. cm.	-	col.
42584-02	27x10x4,5	-	●
42584M02	27x10x4,5	NEW	●



Cutlery dispenser
Portaposate
Besteck-Ablage
Panier à couverts
Cesta portacubiertos

art.	Ø cm.	h. cm.	-	col.
42584-01	12	15	-	●
42584M01	12	15	NEW	●



Bread basket
Cesto pane
Brotkorb
Corbeille à pain
Cesta pan

art.	dim. cm.	GN	col.
42461-11	56,5x36x10	1/1	●
42967-11	56,5x36x10	1/1	●

With frame to fix the cover.
Con telaio per fissare il coperchio.



Roll-top cover
Coperchio roll-top
Rolltophaube
Couvercle roll-top
Tapa roll-top

art.	dim. cm.	GN
41415-11	53x32,5x17	1/1

Chrome handle. – Maniglia cromata.



Roll-top cover
Coperchio roll-top
Rolltophaube
Couvercle roll-top
Tapa roll-top

art.	dim. cm.	GN
42452-53	53x32,5x17	1/1

Chrome handle. – Maniglia cromata.



Cover
Coperchio
Kuppelhaube
Couvercle
Campana

art.	dim. cm.	GN
41419-12	33x28x17	1/2

One front cut. – Con apertura frontale.



Cover
Coperchio
Kuppelhaube
Couvercle
Campana

art.	dim. cm.	GN
41418-11	54x33x20	1/1

One front cut. – Con apertura frontale.



Cover
Coperchio
Kuppelhaube
Couvercle
Campana

art.	dim. cm.	GN
41418-12	54x33x20	1/1

Totally closed. – Chiuso.



Bread basket
Cesto pane
Brotkorb
Corbeille à pain
Cesta pan

art.	Ø cm.	h. cm.	-	col.
42461B35	35	12	NEW	●
42461-35	35	12	-	●

With frame to fix the cover.
Con telaio per fissare il coperchio.



Roll-top cover
Coperchio roll-top
Rolltophaube
Couvercle roll-top
Campana roll-top

art.	Ø cm.	h. cm.
42452-35	38	20

Chrome handle. – Maniglia cromata.



Roll-top cover
Coperchio roll-top
Rolltophaube
Couvercle roll-top
Campana roll-top

art.	Ø cm.	h. cm.
41447-38	38	20

Chrome knob. – Pomolo cromato.



Roll-top cover
Coperchio roll-top
Rolltophaube
Couvercle roll-top
Campana roll-top

art.	Ø cm.	h. cm.
41945-38	38	20

Chrome knob. – Pomolo cromato.

POLYPROPYLENE BASKETS
CESTI IN POLIPROPILENE SERIE LINE



Bread basket

Cesto pane
Brotkorb
Corbeille à pain
Cesta pan

art.	Ø cm.	h. cm.
42948-18	10	7
42948-20	20	7
42948-25	25	7



Bread basket

Cesto pane
Brotkorb
Corbeille à pain
Cesta pan

art.	dim. cm.
42948-23	23x15x6,5



Bread basket

Cesto pane
Brotkorb
Corbeille à pain
Cesta pan

art.	Ø cm.	h. cm.
42935-19	19	9
42935-26	26	9



Bread basket

Cesto pane
Brotkorb
Corbeille à pain
Cesta pan

art.	Ø cm.	h. cm.
42944-23	23	7



Bread basket

Cesto pane
Brotkorb
Corbeille à pain
Cesta pan

art.	dim. cm.
42945-27	27x20x10



Bread basket

Cesto pane
Brotkorb
Corbeille à pain
Cesta pan

art.	dim. cm.
42945-18	18x13x6,5
42945-23	23x15x6,5





Bread basket

Cesto pane
Brotkorb
Corbeille à pain
Cesta pan

art.	dim. cm.
42936-23	23x19x9



Bread basket

Cesto pane
Brotkorb
Corbeille à pain
Cesta pan

art.	dim. cm.
42936-24	24x17x8
42936-28	28x16x8,5



Bread basket

Cesto pane
Brotkorb
Corbeille à pain
Cesta pan

art.	dim. cm.
42946-23	23x10x6
42946-37	37,5x15x7



Bread basket

Cesto pane
Brotkorb
Corbeille à pain
Cesta pan

art.	dim. cm.
42947-23	23x15x7
42947-30	30x22x7
42947-40	41x29x7



Bread basket

Cesto pane
Brotkorb
Corbeille à pain
Cesta pan

art.	Ø cm.	h. cm.
42968-38	38	10



Bread basket stand

Alzata ceste
Körbe-Gestell
Etagère à corbeilles
Soporte ceste pan

art.	dim. cm.
42870-59	30,5x59x58

For baskets 42968-38 and 42967-13.
Per cesti 42968-38 e 42967-13.



Basket with black wire stand

Cesto con supporto filo nero
Korbdrahtgestell, schwarz
Panier support en fil noir
Cesta estructura alambre negro

art.	dim. cm.
41220-02	40x30
41220-03	60x40



Basket with black wire stand

Cesto con supporto filo nero
Korbdrahtgestell, schwarz
Panier support en fil noir
Cesta estructura alambre negro

art.	Ø cm.	h. cm.
41220-01	38	15,5



Basket with black wire stand

Cesto con supporto filo nero
Korbdrahtgestell, schwarz
Panier support en fil noir
Cesta estructura alambre negro

art.	Ø cm.	h. cm.
41220-04	33	15,5



Basket with black wire stand

Cesto con supporto filo nero
Korbdrahtgestell, schwarz
Panier support en fil noir
Cesta estructura alambre negro

art.	Ø cm.	h. cm.
41220-05	43	15,5



Wire stand black, 2 tiers

Supporto filo nero, 2 piani
Brotkorb-Drahtgestell, Doppeldecker
Support en fil noir, 2 étages
Estructura alambre negro, 2 alturas

art.	dim. cm.	GN
41220-06	44,5x26x22	1/2

Baskets not included. – Cesti non inclusi.



Wire stand black

Supporto filo nero
Drahtgestell, schwarz
Support en fil noir
Estructura alambre negro

art.	dim. cm.	GN
41220-07	49,5x30x13,5	1/1

Basket not included. – Cesto non incluso.



Black wire basket

Cesto in filo nero
Drahtkorb, schwarz
Panier en fil noir
Cesta alambre negro

art.	dim. cm.	GN
41220-11	53x32,5x7,5	1/1

**Fits cover / Coperchio idoneo:
41418B11, 41418-11, 41418-12.**



Black wire basket

Cesto in filo nero
Drahtkorb, schwarz
Panier en fil noir
Cesta alambre negro

art.	dim. cm.	GN
41220-12	32,5x26,5x7,5	1/2

**Fits cover / Coperchio idoneo:
41419B12, 41419-12.**



Black wire basket

Cesto in filo nero
Drahtkorb, schwarz
Panier en fil noir
Cesta alambre negro

art.	dim. cm.	GN
41220-24	53x16,2x7,5	2/4

Fits cover / Coperchio idoneo: 41420-24.



Cover front cut

Coperchio apertura frontale
Kuppelhaube, Front-Ausschnitt
Couvercle ouverture frontale
Campana apertura frontal

art.	dim. cm.	GN
41418B11	54x33x20	1/1

Die cast zinc knob. – Maniglia in zinco pressofuso.



Cover front cut

Coperchio apertura frontale
Kuppelhaube, Front-Ausschnitt
Couvercle ouverture frontale
Campana apertura frontal

art.	dim. cm.	GN
41419B12	33x28x17	1/2

Die cast zinc knob. – Maniglia in zinco pressofuso.



Canvas egg bag

Cesto uova cotone
Eiertasche, Baumwolle
Panier à oeufs, coton
Cesta huevos, algodón

art.	Ø cm.	h. cm.	col.
42873-01	20	23,5	●
42873-02	20	23,5	●

With stone pillow. To heat up in microwave for 90 sec. at 500 Watt. Machine washable up to 30°C (except pillow). – Con cuscino noccioli di ceramica. Scaldare in microonde per 90 secondi a 500 Watt. Lavabile in lavatrice max 30°C (escluso cuscino).





Canvas bag, round

Cesto cotone, rotondo
Brottasche, rund, Baumwolle
Panier à pain rond, coton
Cesta pan redonda, algodón

art.	Ø cm.	h. cm.	col.
42875-17	17	11	●
42875-20	20	12	●

Cotton, machine-washable up to 30° C.
Cotone, lavabile a macchina fino a 30° C.



Canvas bag, round

Cesto cotone, rotondo
Brottasche, rund, Baumwolle
Panier à pain rond, coton
Cesta pan redonda, algodón

art.	Ø cm.	h. cm.	col.
42875B17	17	11	●
42875B20	20	12	●

Cotton, machine-washable up to 30° C.
Cotone, lavabile a macchina fino a 30° C.



NEW

Canvas bag, round

Cesto cotone, rotondo
Brottasche, rund, Baumwolle
Panier à pain rond, coton
Cesta pan redonda, algodón

art.	Ø cm.	h. cm.	col.
42876-12	12	15	●

Cotton, machine-washable up to 30° C.
Cotone, lavabile a macchina fino a 30° C.



Canvas bag, oval

Cesto cotone, ovale
Brottasche, oval, Baumwolle
Panier à pain ovale, coton
Cesta pan , algodón

art.	dim. cm.	col.
42876-20	20x15x10	●
42876-25	25x18x12	●

Cotton, machine-washable up to 30° C.
Cotone, lavabile a macchina fino a 30° C.



NEW



Buffet box 2 compartments

Espositore buffet 2 sezioni
Buffet Box, 2 Fächer
Boîte à buffet 2 sections
Caja para buffet 2 secciones

art.	dim. cm.
42464-02	36x33,5x16

Natural oak. – Rovere naturale.



NEW



Buffet box

Espositore buffet
Buffet Box
Boîte à buffet
Caja para buffet

art.	dim. cm.	ext.
42464-03	36x29x28	70,5x37x53,5

Natural oak. – Rovere naturale.



NEW



Bread box

Cassetta pane
Brotkiste
Caisse à pain
Cajón para pan

art.	dim. cm.
42874-01	34x26x12,5
42874-02	34x26x20

Beech wood. – Faggio.



Bread cutting board

Tagliere
Brotschneidbrett
Planche à découper
Tabla de corte

art. dim. cm.
42874-03 52x34x2

Beech wood. – Faggio.



Cutting board tray

Vassoio per tagliere
Schneidbrett-Tablett
Plateau pour planche à découper
Bandeja para tabla de corte

art. dim. cm.
42874-04 60x35,5x3,5



Bread slicer

Taglia pane
Brotschneidergerät
Coupe-pain
Corta-pan

art. dim. cm.
49833-00 40x11x15

Stainless steel blade 35 cm. – Lama inox 35 cm.



Pretzel stand

Porta Brezel
Brezel-ständer
Support à brezel
Soporte para brezel

art. Ø cm. h. cm.
42870-50 22 50

Beechwood. – Faggio.



Sign holders, chromed

Clip flessibili, cromate
Schildhalter, verchromt
Porte-étiquettes, chromés
Porta etiquetas con clip, cromade

art. l. cm. pcs/pz
41394-02 12 1



All purpose tongs

Molla universale
Universalzange
Pince universelle
Pinza universal

art. l. cm. col.
41506-19 19,5 ●
41506C19 19,5 ●
41506B19 19,5 ●

Mirror polished, with fastening clip.
Finitura lucida, con clip di fissaggio.





Chalkmarker

Penna a gesso liquido

Kreidestifte

Stylo à craie liquide

Rotulador de tiza líquida

art.	Ø mm.	col.
47832-00	5	○
47832-01	5	●
47832-02	5	●
47832-03	5	●
47832-04	5	●
47832-05	5	●

Clean with water. Writes on all non porous surfaces. – Pulire con acqua. Scrive su tutte le superfici non porose.



Chalkmarker

Penna a gesso liquido

Kreidestifte

Stylo à craie liquide

Rotulador de tiza líquida

art.	Ø mm.	col.
47832-10	15	○
47832-11	15	●
47832-12	15	●
47832-13	15	●
47832-14	15	●
47832-15	15	●



Sandwich board

Lavagna cavalletto bifacciale

Gehwegtafel

Tableau chevalet 2 faces

Pizarra en ángulo

art.	dim. cm.	h. cm.
44185-50	50x72	85
44185-70	69x100	120

MDF surface with wooden frame. Lavagna in MDF con cornice in legno.



Wall board

Lavagna da muro

Wandtafel

Tableau mural

Pizarra murale

art.	dim. cm.
44187-40	40x60
44187-60	60x80

MDF surface. – Lavagna in MDF.

BUFFET SYSTEM



ACACIA WOOD for a multifunctional buffet system that adapts in height and width to all space requirements. The stackable and non-slip reversible boxes can be used individually or connected with flat GN trays.

LEGNO DI ACACIA per un sistema multifunzionale che si adatta in altezza e larghezza a tutte le esigenze di spazio. Le scatole reversibili, impilabili e antiscivolo possono essere utilizzate singolarmente o collegate con i piani GN.



Box
Scatola
Wendebox
Boîte
Caja

art.	dim. cm.	GN
42463A02	55,5x35x10,5	1/1



NEW

Box
Scatola
Wendebox
Boîte
Caja

art.	dim. cm.	GN
42463A12	55,5x35x20	1/1



Box
Scatola
Wendebox
Boîte
Caja

art.	dim. cm.	GN
42463A04	55,5x18,5x10,5	2/4



Box
Scatola
Wendebox
Boîte
Caja

art.	dim. cm.	GN
42463A05	35x29x10,5	1/2



NEW

Box
Scatola
Wendebox
Boîte
Caja

art.	dim. cm.	GN
42463A15	35x29x20	1/2



Box
Scatola
Wendebox
Boîte
Caja

art.	dim. cm.	GN
42463A08	29x18,5x10,5	1/4





Box
Scatola
Wendebox
Boîte
Caja

art.	dim. cm.	GN
42463B02	55,5x35x10,5	1/1



NEW

Box
Scatola
Wendebox
Boîte
Caja

art.	dim. cm.	GN
42463B12	55,5x35x20	1/1



Box
Scatola
Wendebox
Boîte
Caja

art.	dim. cm.	GN
42463B04	55,5x18,5x10,5	2/4



Box
Scatola
Wendebox
Boîte
Caja

art.	dim. cm.	GN
42463B05	35x29x10,5	1/2



NEW

Box
Scatola
Wendebox
Boîte
Caja

art.	dim. cm.	GN
42463B15	35x29x20	1/2



Box
Scatola
Wendebox
Boîte
Caja

art.	dim. cm.	GN
42463B08	29x18,5x10,5	1/4



NEW

Buffet stand
Supporto buffet
Buffetgestell
Présentoir buffet
Soporte para buffet

art.	dim. cm.	GN
42463-02	49x38,5x48	1/1-1/2



NEW

Buffet stand 3 pieces
Espositore buffet 3 pezzi
Buffetgestell 3-teilig
Présentoir buffet 3 pièces
Expositor buffet 3 piezas

art.	dim. cm.
42460-40	40x40x33

Rubberwood, wenge.
1. 40x40x33 ; 2. 40x37x20 ; 3. 40x34x9 cm.



NEW

Buffet stand 2-tier

Espositore buffet 2 piani
Buffetgestell 3-stufig
Présentoir buffet 2 étages
Expositor buffet 2 alturas

art. dim. cm.
41209-06 80x23x40,5

Oak wood, metal PVC coated.

Rovere, metallo con rivestimento PVC.



NEW

Buffet board

Mensola buffet
Buffet-Brett
Planche à buffet
Tabla de buffet

art. dim. cm.
41209-05 80x20x2

Oak wood. – Rovere.



NEW

Buffet stand

Supporto buffet
Buffetständer
Présentoir buffet
Soporte para buffet

art. dim. cm.
41209-02 19x23x40,5



NEW

Buffet stand

Supporto buffet
Buffetständer
Présentoir buffet
Soporte para buffet

art. dim. cm.
41209-01 12x12x7

Metal PVC coated.

Metallo con rivestimento PVC.



NEW

Buffet board

Tavola buffet
Buffet-Brett
Planche à buffet
Tabla de buffet

art. dim. cm. GN
41209-03 53x32,5x2,5 1/1

Oiled oak wood board.

Tavola in legno di rovere oliato.



NEW

Buffet board

Tavola buffet
Buffet-Brett
Planche à buffet
Tabla de buffet

art. dim. cm. GN
41209-04 53x16,5x2,5 2/4

Oiled oak wood board.

Tavola in legno di rovere oliato.



NEW

W

SAN

SS

Showplate, 3-pcs set

Vetrina, set 3 pezzi
Buffetvitrine, 3-teilig
Etagère, set 3 pièces
Vitrina, 3 elementos

art. Ø cm. h. cm.
41905-38 43 4,5

Roll-top 41447-38 not included.

Coperchio 41447-38 non incluso.





SAN

Roll-top cover
Coperchio roll-top
Rolltophaube
Couvercle roll-top
Campana roll-top

art.	Ø cm.	h. cm.
41447-38	38	20

Chrome knob. – Pomolo cromato.



SAN

SS

Showplate, 2-pcs set
Vetrina, set 2 pezzi
Buffetvitrine, 2-teilig
Etagère, set 2 pièces
Vitrina, 2 elementos

art.	Ø cm.	h. cm.
41447-02	38	21



SAN

SS

Showplate, 5-pcs set
Vetrina, set 5 pezzi
Buffetvitrine, 5-teilig
Etagère, set 5 pièces
Vitrina, 5 elementos

art.	Ø cm.	h. cm.
41447-05	38	24



SAN

Roll-top cover
Coperchio roll-top
Rolltophaube
Couvercle roll-top
Campana roll-top

art.	Ø cm.	h. cm.
41945-38	38	20



PC

Roll-top cover
Coperchio roll-top
Rolltophaube
Couvercle roll-top
Campana roll-top

art.	dim. cm.	GN
41415-11	53x32,5x17	1/1

Chrome knob. – Pomolo cromato.



W

PP

PS

Ice-box, 3 pcs set
Box portagiaccio, set 3 pz
Eisbox, 3-teilig
Boîte à glaçons, 3 pièces
Cubitera, 3 elementos

art.	dim. cm.
41412-11	53x32,5x12,5

Box wenge + plastic deep tray + drainer plate.
Base wengé + vasca plastica + griglia.

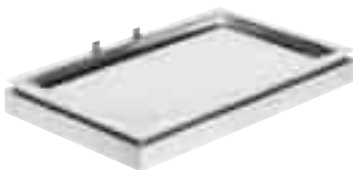

SS

Cool plate
Vetrina refrigerata
Buffet-Vitrine, kühlbar
Vitrine réfrigérée
Vitrina refrigerada

art.	dim. cm.	GN
42450-00	53x32,5x8,5	1/1

GN 1/1 base element, s/s platter, cooler.
Base GN 1/1, vassoio inox, eutettico.



W

SS

Cool plate
Vetrina refrigerata
Buffet-Vitrine, kühlbar
Vitrine réfrigérée
Vitrina refrigerada

art.	dim. cm.	GN
42460-00	53x32,5x8,5	1/1

GN 1/1 base element, s/s platter, cooler.
Base GN 1/1, vassoio inox, eutettico.



W

SS

Cool plate
Vetrina refrigerata
Buffet-Vitrine, kühlbar
Vitrine réfrigérée
Vitrina refrigerada

art.	dim. cm.	GN
42470-00	53x32,5x8,5	1/1

GN 1/1 base element, s/s platter, cooler.
Base GN 1/1, vassoio inox, eutettico.



Eutectic pad

Accumulatore di freddo
Kühlakku
Cartouche eutectique
Placa eutética

art.	dim. cm.
42450-AD	41x21x2,5



GN roll-top cover

Coperchio GN roll-top
GN-Rolltophaube
Couvercle roll-top, GN
Tapa roll-top, GN

art.	GN
42452-53	1/1



Tray

Vassoio
Tablett
Plateau
Bandeja

art.	GN
42451-11	1/1
42451-12	1/2



Cutting board

Tagliere
Tranchierbrett
Planche à découper
Plancha para cortar

art.	GN
42470-06	1/1



Cutting board

Tagliere
Tranchierbrett
Planche à découper
Plancha para cortar

art.	GN
42460-06	1/1



Cooled buffet showcase

Vetrina refrigerata
Buffet-Vitrine, kühlbar
Vitrine réfrigérée
Vitrina refrigerada

art.	dim. cm.	col.
42470-63	63,5x42,5x31	●

Woodbase with fixed roll-top cover, plastic case, GN 1/1 melamine tray, cooling unit. – Base legno con coperchio roll-top fisso, vasca plastica, GN 1/1 in melamina, placca eutettica.



Cooled buffet showcase

Vetrina refrigerata
Buffet-Vitrine, kühlbar
Vitrine réfrigérée
Vitrina refrigerada

art.	dim. cm.	col.
42460-63	63,5x42,5x31	●

Woodbase with fixed roll-top cover, plastic case, GN 1/1 melamine tray, cooling unit. – Base legno con coperchio roll-top fisso, vasca plastica, GN 1/1 in melamina, placca eutettica.



Cutlery dispenser

Portaposate
Besteck-Behälter
Bac à couverts
Caja portacubiertos

art.	dim. cm.	col.
42470-64	57,5x37x12	●



Cutlery dispenser

Portaposate
Besteck-Behälter
Bac à couverts
Caja portacubiertos

art.	dim. cm.	col.
42460-64	57,5x37x12	●



MF

Bowl

Ciotola
Schüssel
Bol
Cuenco

art.	Ø cm.	h. cm.	lt.	col.
44837B05	14	6,5	0,5	●
44837B20	20	9,2	1,8	●
44837B25	23	10,0	2,5	●



MF

Bowl

Ciotola
Schüssel
Bol
Cuenco

art.	Ø cm.	h. cm.	lt.	col.
44837-05	14	6,5	0,5	○
44837-20	20	9,2	1,8	○
44837-25	23	10,0	2,5	○



Set 12 small bowls

Conf. 12 ciotoline
Satz 12 Mini-Gläser
Set 12 mini bols
Juego 12 cuencos

art.	Ø cm.	h. cm.	ml.
41204-10	7	5,5	90



Bowl, glass

Ciotola, vetro
Glasschüssel
Bol en verre
Cuenco vidrio

art.	Ø cm.	h. cm.	lt.
41425-AA	7,5	3,5	0,09
41405-AA	14,0	6,5	0,5
41400-AA	23,0	10,0	2,5



PC

Airtight cover

Coperchio ermetico
Frischhaltedeckel
Couvercle hermétique
Tapa hermética

art.	Ø cm.
42452-14	14
42452-23	23



AY

Cover

Coperchio
Deckel
Couvercle
Tapa

art.	Ø cm.
42453-23	23



W

Cool bowl

Ciotola refrigerata
Kühlschale
Bol réfrigérée
Cuenco refrigerdo

art.	dim. cm.	lt.	col.
42470-27	27,5x27,5x14	2,5	●

Wood base, s/s container, melamine bowl, cooling unit. – Base legno, contenitore inox, ciotola melamina, placca eutettica.



W

Cool bowl

Ciotola refrigerata
Kühlschale
Bol réfrigérée
Cuenco refrigerdo

art.	dim. cm.	lt.	col.
42460-27	27,5x27,5x14	2,5	●

Wood base, s/s container, melamine bowl, cooling unit. – Base legno, contenitore inox, ciotola melamina, placca eutettica.



BUFFET DISPLAY & PRESENTATION



AY

PC

SS

Cool bowl

Ciotola refrigerata
Kühlschale
Bol réfrigérée
Cuenco refrigerado

art.	Ø cm.	h. cm.	lt.
41448-06	14	9,0	0,6
41448-10	14	11,5	1,0

Base + cooler + bowl + cover.

Base + eutettico + ciotola + coperchio.



AY

PC

SS

Cool bowl

Ciotola refrigerata
Kühlschale
Bol réfrigérée
Cuenco refrigerado

art.	Ø cm.	h. cm.	lt.
41448-25	22	14	2,5
41448-40	22	18	4,0

Base + cooler + bowl + cover.

Base + eutettico + ciotola + coperchio.



Buffet stand, chrome plated

Alzata, cromata
Buffet-Gestell, Metall hartverchromt
Présentoir, chromé
Soporte, cromado

art.	dim. cm.
41442-03	61x24x35

3 glass bowls ø cm 23 + 3 covers.

3 ciotole ø cm 23 + covers.



MF

Bowl

Ciotola
Schüssel
Bol
Cuenco

art.	dim. cm.	col.
44884-12	12,5x12,5x6	○
44884-19	19x19x9,5	○
44884-25	25x25x12	○
44884B12	12,5x12,5x6	●
44884B19	19x19x9,5	●
44884B25	25x25x12	●



SAN

Cover

Coperchlo
Deckel
Couvercle
Tapa

art.	dim. cm.
44885-19	19x19
44885-25	25x25

With spoon notch. – Con spacco cucchiaio.



Serving stand, chrome plated

Alzata, cromata
Serviergestell, Metall hartverchromt
Présentoir, chromé
Soporte platos, cromado

art.	dim. cm.	col.
42962C26	18,5x15,5x26	●
42962C44	29x19,5x43	●

26: for 3 plates max. Ø 17 cm, inside Ø 10,5 cm.

44: for 3 plates max. Ø 27 cm, inside Ø 18 cm.



Serving stand

Alzata
Serviergestell
Présentoir
Soporte platos

art.	dim. cm.
42962-26	18,5x15,5x26
42962-30	29x19,5x30
42962-44	29x19,5x43

26: for 3 plates max. Ø 17 cm, inside Ø 10,5 cm.

30: for 2 plates max. Ø 27 cm, inside Ø 18 cm.

44: for 3 plates max. Ø 27 cm, inside Ø 18 cm.



NEW

Serving stand

Alzata
Serviergestell
Présentoir
Soporte platos

art.	dim. cm.
42962B30	29x19,5x30
42962B44	29x19,5x43

30: for 2 plates max. Ø 27 cm, inside Ø 18 cm.

44: for 3 plates max. Ø 27 cm, inside Ø 18 cm.



Buffet ladder, chrome plated

Espositore buffet, cromato
Buffet-Leiter, verchromt
Escalier à buffet, chromé
Escalera para buffet, cromada

art.	dim. cm.
41912-03	30x30x48

With 4 bowls ø cm 14 + lids.

Con 4 ciotole ø cm 14 + coperchi.





Buffet ladder, chrome plated

Espositore buffet, cromato
Büffet-Leiter, verchromt
Escalier à buffet, chromé
Escalera para buffet, cromada

art. dim. cm.
41912-04 30x30x48

With 6 bowls ø cm 14. – Con 6 ciotole ø cm 14.



Buffet ladder, chrome plated

Espositore buffet, cromato
Büffet-Leiter, verchromt
Escalier à buffet, chromé
Escalera para buffet, cromada

art. dim. cm.
41913-03 39x31x66

With 4 bowls ø cm 23 + lids.
Con 4 ciotole ø cm 23 + coperchi.



Buffet ladder, chrome plated

Espositore buffet, cromato
Büffet-Leiter, verchromt
Escalier à buffet, chromé
Escalera para buffet, cromada

art. dim. cm.
41913-04 39x31x66

With 6 bowls ø cm 23. – Con 6 ciotole ø cm 23.



GN

Buffet ladder, chrome plated

Espositore buffet, cromato
Büffet-Leiter, verchromt
Escalier à buffet, chromé
Escalera para buffet, cromada

art. dim. cm. GN
41403-01 31,5x32x48 1/3



GN

Buffet ladder, chrome plated

Espositore buffet, cromato
Büffet-Leiter, verchromt
Escalier à buffet, chromé
Escalera para buffet, cromada

art. dim. cm. GN
41403-02 31,5x41,5x48 1/2





Buffet ladder, chrome plated

Espositore buffet, cromato
Büffet-Leiter, verchromt
Escalier à buffet, chromé
Escalera para buffet, cromada

art. dim. cm. GN
41403-03 31,5x56x66 1/2



Buffet ladder, chrome plated

Espositore buffet, cromato
Büffet-Leiter, verchromt
Escalier à buffet, chromé
Escalera para buffet, cromada

art. dim. cm. GN
41403-04 52x59x66 1/1



Multi rack

Multi-distributore
Multi Rack
Distributeur
Dispensador

art. dim. cm.
41911-02 19x24x28



Multi rack

Multi-distributore
Multi Rack
Distributeur
Dispensador

art. dim. cm.
41911-03 19x24x41



Multi rack

Multi-distributore
Multi Rack
Distributeur
Dispensador

art. dim. cm.
41911-04 19x24x53



Canister with lid, glass

Barattolo vetro con coperchio
Vorratsglas
Bocal en verre avec couvercle
Tarro vidrio con tapa

art.	Ø cm.	h. cm.	lt.
41590-01	11,5	16,0	0,9
41590-02	14,0	21,5	2,0
41590-04	18,0	26,0	4,0
41590-06	20,0	30,0	6,0

Lid with seal. – Tappo con guarnizione.



Canister with lid, glass

Barattolo vetro con coperchio
Vorratsglas
Bocal en verre avec couvercle
Tarro vidrio con tapa

art.	Ø cm.	h. cm.	lt.
41591-10	11	18	1,0
41591-15	12	21	1,5

Lid with seal. – Tappo con guarnizione.





W

Cereal-bar

Espositore cereali
Cerealien-Buffer-Ständer
Présentoir à céréales
Expositor de cereale

art.	dim. cm.	col.
42470-43	43x17x13,5	●

3 glasses lt. 2 with airtight cover.
3 vasi lt. 2 con coperchio ermetico.



W

Cereal-bar

Espositore cereali
Cerealienständer
Présentoir à céréales
Expositor de cereales

art.	dim. cm.	col.
42460-43	43x17x13,5	●

3 glasses lt. 2 with airtight cover.
3 vasi lt. 2 con coperchio ermetico.



Jam bar

Espositore marmellate
Konfitürenständer
Présentoir à confitures
Expositor de mermeladas

art.	dim. cm.	ml.
41206-05	34,5x9x8,5	3x176



AY

Cereal-bar

Espositore per cereali
Cerealien-Bar
Présentoir à céréales
Expositor de cereales

art.	dim. cm.	lt.
41806-03	39,5x12x26	3x1



AY

Cereal pitcher

Caraffa cereali
Cerealienkaraffe
Pichet à céréales
Jarra de cereales

art.	Ø cm.	dim. cm.	lt.
41806-00	9	25,5	1



NEW

SAN

SS

Cereal dispenser

Distributore di cereali
Cerealienspender
Distributeur à céréales
Dispensador de cereales

art.	dim. cm.	lt.
41810B04	22x17,5x52	4,5



SAN

SS

Cereal dispenser

Distributore di cereali
Cerealienspender
Distributeur à céréales
Dispensador de cereales

art.	dim. cm.	lt.
41810-04	22x17,5x52	4,5



SAN

SS

Cereal dispenser

Distributore di cereali
Cerealienspender
Distributeur à céréales
Dispensador de cereales

art.	dim. cm.	lt.
41810-09	22x35x52	2x4,5



PC

SS

Cereal dispenser

Distributore di cereali
Cerealienspender
Distributeur à céréales
Dispensador de cereales

art.	dim. cm.	lt.
41909-08	33x24x64	7



PC

SS

Cereal dispenser

Distributore di cereali
Cerealienspender
Distributeur à céréales
Dispensador de cereales

art.	dim. cm.	lt.
41807-12	30,5x28,5x60,5	3x4



SS

SS

Juice dispenser

Distributore di succhi
Saftdispenser
Distributeur à jus
Dispensador de zumos

art.	dim. cm.	lt.
41901-08	36x26x55	8



SS

SS

Juice dispenser duo

Distributore di succhi duo
Saftdispenser duo
Distributeur à jus duo
Dispensador de zumo, doble

art.	dim. cm.	lt.
41901-16	36x54x55	2x8



SS

SS

Juice dispenser

Distributore di succhi
Saftdispenser
Distributeur à jus
Dispensador de zumos

art.	dim. cm.	lt.
18353-17	22x35x56	7

With 1 cooling unit. – Con 1 eutettico.



SS

SS

Juice dispenser

Distributore di succhi
Saftdispenser
Distributeur à jus
Dispensador de zumos

art.	dim. cm.	lt.
41800-05	33x22x52	5



SS

SS

Juice dispenser duo

Distributore di succhi duo
Saftdispenser duo
Distributeur à jus duo
Dispensador de zumo, doble

art.	dim. cm.	lt.
41800-10	42,5x30,5x52	2x5



SS

SS

Milk dispenser

Distributore di latte
Milchkanne
Distributeur à lait
Dispensador de leche

art.	dim. cm.	lt.
41801-05	33x22x50	5



W

Cereal dispenser

Distributore di cereali
Cerealienspender
Distributeur à céréales
Dispensador de cereales

art.	dim. cm.	lt.	col.
42470-45	21x20x55,5	4,5	●
42460-45	21x20x55,5	4,5	●

Maple/Wenge. – Acero/Wengè.





NEW

Beverage dispenser

Distributore di bevande
Getränkspender
Distributeur de boissons
Dispensador de bebidas

art.	Ø cm.	h. cm.	lt.
41808B07	20	45	7

Glass container, s/s tap, base and lid black metal. – Contenitore in vetro, rubinetto inox, base e coperchio in metallo nero.



NEW

SS

MF

Drip tray

Griglia raccogli gocce
Tropfenschale
Bac d'égouttage
Rejilla recoge gotas

art.	Ø cm.	h. cm.
41808B90	9,5	1,5



W

Juice dispenser

Distributore di succhi
Saftdispenser
Distributeur à jus de fruit
Dispensador de zumo

art.	dim. cm.	lt.
41808-04	16x24x35	4



W

Juice dispenser

Distributore di succhi
Saftdispenser
Distributeur à jus de fruit
Dispensador de zumo

art.	dim. cm.	lt.	col.
42470-74	31x20x42	4	●
42470-76	35,5x22x50	6	●

Maple. With 2 cooling units. elements, top and base. – Acero. Con 2 eutettici, coperchio e base.



W

Juice dispenser

Distributore di succhi
Saftdispenser
Distributeur à jus de fruit
Dispensador de zumo

art.	dim. cm.	lt.	col.
42460-74	31x20x42	4	●
42460-76	35,5x22x50	6	●

Wenge. With 2 cooling units. elements, top and base. – Wengè. Con 2 eutettici, coperchio e base.



W

PR

SS

Milk dispenser

Distributore di latte
Milchkanne
Distributeur à lait
Dispensador de leche

art.	dim. cm.	lt.
41900-04	23x32x42	4
41900-10	27x38,5x45	10

Beechwood. With cooling units.
Faggio. Con eutettici.



SS

PP

Insulated dispenser

Distributore termico
Iso-Dispenser
Distributeur isothermique
Dispensador térmico

art.	Ø cm.	h. cm.	lt.
41904-10	24	42>46,5	9,5



SS

Air pot

Caraffa termica
Thermopumpkanne
Pot à air isothermique
Jarra térmica

art.	lt.
42406-35	3,5
42406-40	4,0



SS

Air pot

Caraffa termica
Thermopumpkanne
Pot à air isothermique
Jarra térmica

art.	lt.
42400-19	1,9
42400-25	2,5
42400-30	3,0

ATLANTIC BUFFET SYSTEM

BUFFET & PRESENTATION



Conceived and designed in the round and rectangular versions with different opening systems to meet any need ABS Atlantic Buffet System chafing dishes combine contemporary flexibility and functionality. All the parts of these simple-shaped, stackable, 100% stainless steel hygienic items can be easily taken apart for thorough cleaning.

The line comes from the expertise that only Sambonet Paderno can offer to top catering services. The lid is equipped with a new, transparent window made of unbreakable glass that lets you see the delicacies held in the chafing dishes. The gradual closing mechanism and the special lid removal method make the whole System even more effective.

Pensati e ideati nelle versioni rotonde, rettangolari con aperture differenziate per soddisfare ogni esigenza, gli scaldavivande ABS Atlantic Buffet System interpretano la funzionalità e la flessibilità contemporanea. Semplici nella forma, impilabili, igienici poiché realizzati in acciaio inox, facilmente smontabili in tutte le loro parti per una pulizia impeccabile, gli elementi appartenenti alla linea nascono dall'expertise che solo Sambonet Paderno è in grado di garantire alla ristorazione d'eccellenza. Grazie alla trasparenza del nuovo oblò in vetro temperato, i coperchi offrono visibilità alla prelibatezza dei contenuti degli scaldavivande. Il meccanismo di chiusura graduale e lo speciale metodo di rimozione dei coperchi rende ancora più performante l'intero Sistema.



ATLANTIC TOP UNITS - DA APPOGGIO



TOP UNIT - Chafing dish round

Scaldavivande tondo
Chafing Dish, rund
Chafing dish rond
Chafing dish redondo

art.	Ø cm.	h. cm.	lt.
18176-30	30	15	2,8
18176-36	36	15	5,0
18176-40	40	17	7,8



TOP UNIT - Chafing dish round

Scaldavivande tondo
Chafing Dish, rund
Chafing dish rond
Chafing dish redondo

art.	Ø cm.	h. cm.	lt.
18176I30	30	15	2,8
18176I36	36	15	5,0
18176I40	40	17	7,8



TOP UNIT - Chafing dish round

Scaldavivande tondo
Chafing Dish, rund
Chafing dish rond
Chafing dish redondo

art.	Ø cm.	h. cm.	lt.
18166-24	24	15	2,0
18166-30	30	15	2,8
18166-36	36	15	5,0
18166-40	40	17	7,8



TOP UNIT - Chafing dish round

Scaldavivande tondo
Chafing Dish, rund
Chafing dish rond
Chafing dish redondo

art.	Ø cm.	h. cm.	lt.
18166I30	30	15	2,8
18166I36	36	15	5,0
18166I40	40	17	7,8



TOP UNIT - Chafing dish rectangular

Scaldavivande rettangolare
Chafing Dish, rechteckig
Chafing dish rectangulaire
Chafing dish rectangular

art.	dim. cm.	lt.
18172-54	57x47x18	10



TOP UNIT - Chafing dish rectangular

Scaldavivande rettangolare
Chafing Dish, rechteckig
Chafing dish rectangulaire
Chafing dish rectangular

art.	dim. cm.	lt.
18162-54	57x47x18	10

ATLANTIC BUILT-IN UNITS - DA INCASSO



BUILT-IN UNIT - Chafing dish rectangular

Scaldavivande rettangolare
Chafing Dish, rechteckig
Chafing dish rectangulaire
Chafing dish rectangular

art.	dim. cm.	lt.	std	V-W
18162A55	57x47x18	10		
18162E55	57x47x18	10	EU	250-360
18162U55	57x47x18	10	US	120-450



art.	dim. cm.	lt.	std	V-W
18172A55	57x47x18	10		
18172E55	57x47x18	10	EU	250-360
18172U55	57x47x18	10	US	120-450

ATLANTIC ON STAND UNITS - CON SUPPORTO



Chafing dish, solid alcohol heating

Scaldavivande a combustibile solido
Chafing Dish mit Brennstoff beheizt
Chafing dish chauffage combustible solide
Chafing dish calefacción combustible sólido

art.	Ø cm.	h. cm.	lt.
18176A30	30	27	2,8
18176A36	36	27	5,0
18176A40	40	28	7,8



Chafing dish, solid alcohol heating

Scaldavivande a combustibile solido
Chafing Dish mit Brennstoff beheizt
Chafing dish chauffage combustible solide
Chafing dish calefacción combustible sólido

art.	Ø cm.	h. cm.	lt.
18166A24	24	27	2,0
18166A30	30	27	2,8
18166A36	36	27	5,0
18166A40	40	28	7,8



Chafing dish, electric heating

Scaldavivande, riscaldamento elettrico
Chafing Dish, elektrisch beheizt
Chafing dish chauffage électrique
Chafing dish calefacción eléctrica

art.	Ø cm.	h. cm.	lt.	std	V-W
18176E30	30	27	2,8	EU	250-190
18176E36	36	27	5,0	EU	250-190
18176E40	40	28	7,8	EU	250-190
18176U36	36	27	5,0	US	120-240
18176U40	40	28	7,8	US	120-240





Chafing dish, electric heating

Scaldavivande, riscaldamento elettrico
Chafing Dish, elektrisch beheizt
Chafing dish chauffage électrique
Chafing dish calefacción eléctrica

art.	Ø cm.	h. cm.	lt.	std	V-W
18166E24	24	27	2,0	EU	250-80
18166E30	30	27	2,8	EU	250-190
18166E36	36	27	5,0	EU	250-190
18166E40	40	28	7,8	EU	250-190
18166U24	24	27	2,0	US	120-170
18166U36	36	27	5,0	US	120-240
18166U40	40	28	7,8	US	120-240



Petite marmite

Petite marmite
Petite marmite
Petite marmite
Petite marmite

art.	Ø cm.	h. cm.	lt.	std	V-W
18168A24	24	35	7	-	-
18168E24	24	35	7	EU	250-80
18168U24	24	35	7	US	120-170

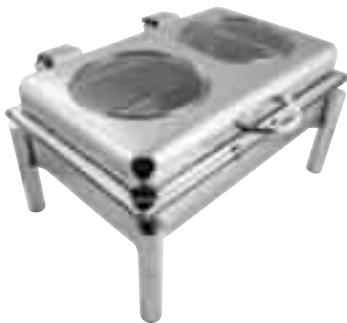

Chafing dish rectangular

Scaldavivande rettangolare
Chafing Dish, rechteckig
Chafing dish rectangulaire
Chafing dish rectangular

art.	dim. cm.	lt.	std	V-W
18172A54	57x47x30,5	10	-	-
18172E54	57x47x30,5	10	EU	250-360
18172U54	57x47x30,5	10	US	120-450



Chafing dish rectangular

Scaldavivande rettangolare
Chafing Dish, rechteckig
Chafing dish rectangulaire
Chafing dish rectangular

art.	dim. cm.	lt.	std	V-W
18162A54	57x47x30,5	10	-	-
18162E54	57x47x30,5	10	EU	250-360
18162U54	57x47x30,5	10	US	120-450

ASIA LINE



Chafing dish rectangular

Scaldavivande rettangolare
Chafing Dish, rechteckig
Chafing dish rectangulaire
Chafing dish rectangular

art.	dim. cm.	lt.	std	V-W
18132A54	67,5x44x42	10	-	-
18132E54	67,5x44x42	10	EU	250-360
18132U54	67,5x44x42	10	US	120-450

Chafing dish, to be built in

Scaldavivande da incasso

Einbau Chafing Dish

Chafing dish encastrable

Chafing dish encastrable

art.	dim. cm.	lt.	std	V-W
18132A55	67,5x44x34,5	10	-	-
18132E55	67,5x44x34,5	10	EU	250-360
18132U55	67,5x44x34,5	10	US	120-450

Chafing dish round

Scaldavivande tondo

Chafing Dish, rund

Chafing dish rond

Chafing dish redondo

art.	Ø cm.	h. cm.	lt.	std	V-W
18136A33	33	44	3,5	-	-
18136E33	33	44	3,5	EU	250-200
18136U33	33	44	3,5	US	120-240
18136A40	40	58	6,0	-	-
18136E40	40	58	6,0	EU	250-360
18136U40	40	58	6,0	US	120-450

Chafing dish round, to be built in

Scaldavivande tondo da incasso

Einbau Chafing Dish, rund

Chafing dish rond encastrable

Chafing dish redondo encastrable

art.	Ø cm.	h. cm.	lt.	std	V-W
18136A34	33	34,5	3,5	-	-
18136E34	33	34,5	3,5	EU	250-200
18136U34	33	34,5	3,5	US	120-240
18136A41	40	43,0	6,0	-	-
18136E41	40	43,0	6,0	EU	250-360
18136U41	40	43,0	6,0	US	120-450

Chafing dish rectangular

Scaldavivande rettangolare

Chafing Dish, rechteckig

Chafing dish rectangulaire

Chafing dish rectangular

art.	dim. cm.	lt.	std	V-W
41690A11	63,5x35x32	8,5	-	-
41690E11	63,5x35x32	8,5	EU	250-360
41690U11	63,5x35x32	8,5	US	120-450

Chafing dish rectangular

Scaldavivande rettangolare

Chafing Dish, rechteckig

Chafing dish rectangulaire

Chafing dish rectangular

art.	dim. cm.	lt.	std	V-W
41691A11	71,5x52x45	8,5	-	-
41691E11	71,5x52x45	8,5	EU	250-360
41691U11	71,5x52x45	8,5	US	120-450





Coffee urn
Scaldacaffè
Kaffeedispenser
Réchaud à café
Calentador de café

art.	dim. cm.	lt.	std	V-W
41903A10	31x33,5x54,5	10,5	-	-
41903E10	31x33,5x54,5	10,5	EU	220-80
41903U10	31x33,5x54,5	10,5	US	110-170



Samovar
Pyramid

art.	dim. cm.	lt.	Tea pot	std	V-W
49856-04	35,5x30x45,2	4	Lt 1,2	EU	2500

Teapot with strainer. Cable length approx. 130 cm. With 2 heating elements 2000W and 500W.
Teiera con colino. Lunghezza cavo circa 130 cm. Con 2 resistenze 2000W e 500W.



Samovar
Romanov

art.	dim. cm.	lt.	Tea pot	std	V-W
49855-05	34x27x59	5	Lt 1,3	EU	1800

Teapot with strainer. Cable length approx. 100 cm. With 2 heating elements 1300W and 500W.
Teiera con colino. Lunghezza cavo circa 100 cm. Con 2 resistenze 1300W e 500W.



Samovar
Soraya

art.	dim. cm.	lt.	Tea pot	std	V-W
49855-10	35,2x44,5x69	10	Lt 1,6	EU	3000

Teapot with strainer. Cable length approx. 130 cm. With 2 heating elements 2300W and 700W.
Teiera con colino. Lunghezza cavo circa 130 cm. Con 2 resistenze 2300W e 700W.



Samovar
Katharina

art.	dim. cm.	lt.	Tea pot	std	V-W
49855-15	39,5x44,5x74,5	15	Lt 2,0	EU	3000

Teapot with strainer. Cable length approx. 130 cm. With 2 heating elements 2300W and 700W.
Teiera con colino. Lunghezza cavo circa 130 cm. Con 2 resistenze 2300W e 700W.



Coffee percolator
Percolatore per caffè
Kaffee-Perkolator
Percolateur à café
Percolator de café

art.	Ø cm.	h. cm.	lt.	std	V-W
49846-05	28	38,5	4,5	EU	950
49846-09	28	38,5	9,2	EU	950
49846-15	33	54	15	EU	1650



Soup kettle
Zuppiera
Suppenwärmer
Marmite à soupe
Olla de sopa

art.	Ø cm.	h. cm.	lt.	std	V-W
49847-38	38	36,5	10	EU	230-450/550



Soup kettle
Zuppiera
Suppenwärmer
Marmite à soupe
Olla de sopa

art.	Ø cm.	h. cm.	lt.	std	V-W
49847-08	33	37	10	EU	230-400



Soup kettle
Zuppiera
Suppenkessel
Marmite à soupe
Olla de sopa

art.	Ø cm.	h. cm.	lt.
49790-09	48	32	10



ACCESSORIES, SPARE PARTS AND COMPONENTS



Induction cooker, to be built into counter
Piastra ad induzione, da incasso
Induktionsplatte, thekeneinbau
Plaque à induction, montage en comptoir
Placa a inducción para emportar

art.	std	dim. cm.
18162-RB	EU	36X38x12,5

Schott ceran hob, timer (0-180 min.), 1-10 power levels, temperature range 60°C-240°C. – Piano in vetroceramica Schott, timer 0-180 minuti, 1-10 livelli di potenza, temperatura 60-240°C.



Induction cooker
Piastra ad induzione
Induktionsplatte
Plaque à induction
Placa a inducción

art.	std	dim. cm.
18162-RA	EU	30X37x10

Stainless steel body, Schott ceran hob, led display, timer (0-180 min.), 1-10 power levels, temperature range 60°C-240°C. – Corpo inox, piano in vetroceramica Schott, display a led, timer 0-180 minuti, 1-10 livelli di potenza, temperatura 60-240°C.



Induction station
Postazione induzione
Induktionsstation
Station d'induction
Estación inducción

art.	std	dim. cm.
49999-04	EU	35,4x32,5x19 900

Induction plate with temperature regulator 60>140°C. Black metal support, walnut wood insert and stainless steel frame. – Piastra a induzione con regolatore di temperatura 60>140°C. Supporto in metallo nero, inserto in legno di noce e cornice inox.



Round stand
Supporto rotondo
Gestell, rund
Support round
Soporte redondo

art.	Ø cm.
18166-AA	24
18166-AM	30
18166-AB	36
18166-AC	40



Rectangular stand
Supporto rettangolare
Gestell, rechteckig
Support rectangulaire
Soporte rectangular

art.	dim. cm.
18162-AA	57x47



Soup tureen without lid
Zuppiera senza coperchio
Suppensüssel ohne Deckel
Soupière sans couvercle
Sopera sin tapa

art.	Ø cm.	lt.
18168-GA	24	7



Round food pan, stainless steel
Portavivande tondo, inox
Einsatzbehälter, rund, Edelstahl Rostfrei
Bac rond, inox
Baño-maria redondo, inox

art.	Ø cm.	h. cm.	lt.
18136-EA	33	6,0	3,5
18136-EB	40	7,5	6,0

For ASIA round chafing dishes.
Per scaldavivande ASIA tondi.



Round food pan, stainless steel
Portavivande tondo, inox
Einsatzbehälter, rund, Edelstahl Rostfrei
Bac rond, inox
Baño-maria redondo, inox

art.	Ø cm.
18166-EG	24
18166-EM	30
18166-EH	36
18166-EI	40

For ABS round chafing dishes.
Per scaldavivande ABS tondi.



Round porcelain insert
Inserto tondo, porcellana
Porzellaneinsatz, rund
Bac rond, porcelaine
Baño-maria redondo, porcelana

art.	Ø cm.	h. cm.
44352-30	33	5,7
44352-40	40	7,5

For ASIA round chafing dishes.
Per scaldavivande ASIA tondi.



Round porcelain insert, 2 food sections
Inserto tondo, porcellana, 2 scomparti
Porzellaneinsatz 2-tlg., rund
Bac rond, porcelaine, 2 compartements
Baño-maria redondo, porcelana 2 compartimentos

art.	Ø cm.	h. cm.
44355-30	37	7,5
44355-40	43	7,5

For ASIA round chafing dishes cm 33-40.
Per scaldavivande ASIA tondi cm 33-40.



Round porcelain insert
Inserto tondo, porcellana
Porzellaneinsatz, rund
Bac rond, porcelaine
Baño-maria redondo, porcelana

art.	Ø cm.
18166-EL	30
18166-EC	36
18166-EB	40

For ABS round chafing dishes.
Per scaldavivande ABS tondi.



Round porcelain insert, 2 food sections
Inserto tondo, porcellana, 2 scomparti
Porzellaneinsatz 2-tlg., rund
Bac rond, porcelaine, 2 compartements
Baño-maria redondo, porcelana 2 compartimentos

art.	Ø cm.
18166-ED	36
18166-EJ	40

For ABS round chafing dishes.
Per scaldavivande ABS tondi.



Food pan GN 1/1, stainless steel
Bacinella GN 1/1, inox
GN-Behälter 1/1, Edelstahl Rostfrei
Bac GN 1/1, inox
Baño-maria GN 1/1, inox

art.	dim. cm.
14102-04	53x32,5x4
14102-06	53x32,5x6,5



Food pan GN 1/1, porcelain
Bacinella GN 1/1, porcellana
GN-Behälter 1/1, Porzellan
Bac GN 1/1, porcelaine
Baño-maria GN 1/1, porcelana

art.	dim. cm.
44332-03	53x32,5x2
44332-06	53x32,5x6,5



Fuel Holder, stainless steel
Portacombustibile, inox
Brennstoffhalterung, Edelstahl Rostfrei
Porte Brûleur, inox
Contenedor de combustible, inox

art.	Ø cm.	h. cm.
41809-09	9	6,5

Suitable for chafing dishes items 41690 and 41691. – Adatto per gli scaldavivande art. 41690 e 41691.



Fuel Holder, stainless steel
Portacombustibile, inox
Brennstoffhalterung, Edelstahl Rostfrei
Porte Brûleur, inox
Contenedor de combustible, inox

art.	Ø cm.	h. cm.
18132-FB	10	7,5

Suitable for chafing dishes items 18152 and 18156. – Adatto per gli scaldavivande art. 18152 e 18156.



Fuel Holder, stainless steel
Portacombustibile, inox
Brennstoffhalterung, Edelstahl Rostfrei
Porte Brûleur, inox
Contenedor de combustible, inox

art.
18136-KA

Kit for ABS round ø cm 24-30-36. – Set per scaldavivande ABS ø cm 24-30-36.



Fuel Holder, stainless steel
Portacombustibile, inox
Brennstoffhalterung, Edelstahl Rostfrei
Porte Brûleur, inox
Contenedor de combustible, inox

art.
18132-KA

Kit for ABS rectangular and round ø cm 40. – Set per scaldavivande ABS rettangolari e ø cm 40.



Jelly fuel

Gel combustibile
Brenngel
Gel combustible
Combustible gel

art.	lt.	gr.
41695-15	-	200
41695-10	1	-
41695-50	5	-



Thermoregulator

Termoregolatore
Thermoregler
Thermorégulateur
Termorregulador

art.	std
18132-AE	EU

For rectangular and round units ø cm 30-33-36-40. – Per scaldavivande rettangolari e tondi ø cm 30-33-36-40.



Thermoregulator

Termoregolatore
Thermoregler
Thermorégulateur
Termorregulador

art.	std
18132-AU	US

For rectangular and round units ø cm 30-33-36-40. – Per scaldavivande rettangolari e tondi ø cm 30-33-36-40.



Electric heating units

Piastre elettriche
Elektro-Heizelemente
Corps de chauffe électriques
Calentadores eléctricos

art.	std	V-W
18136-KE	EU	220-200
18136-KU	US	110-240

Cm. 20x20 - For ASIA round chafing dishes cm 33. – Per scaldavivande ASIA tondo cm 33.



Electric heating units

Piastre elettriche
Elektro-Heizelemente
Corps de chauffe électriques
Calentadores eléctricos

art.	std	V-W
18166-KP	EU	220-180

Cm. 20x21 - For ABS round ø cm 30.
Per scaldavivande ABS tondo ø cm 30.



Electric heating units

Piastre elettriche
Elektro-Heizelemente
Corps de chauffe électriques
Calentadores eléctricos

art.	std	V-W
18166-KE	EU	220-200
18166-KU	US	110-240

Cm. 20x25 - For ABS round ø cm 36-40.
Per scaldavivande ABS tondo ø cm 36-40.

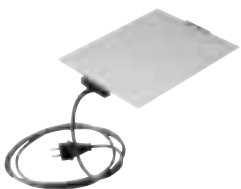

Electric heating units

Piastre elettriche
Elektro-Heizelemente
Corps de chauffe électriques
Calentadores eléctricos

art.	std	V-W
18132-KE	EU	220-380
18132-KU	US	110-450

Cm. 20x25 - For ASIA rectangular and round chafing dishes cm 40. – Per scaldavivande ASIA rettangolari e tondi cm 40.

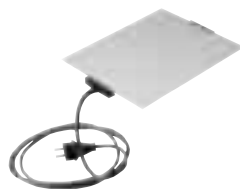

Electric heating units

Piastre elettriche
Elektro-Heizelemente
Corps de chauffe électriques
Calentadores eléctricos

art.	std	V-W
18162-KE	EU	220-380
18162-KU	US	110-450

Cm. 20x25 - For ABS rectangular.
Per scaldavivande ABS rettangolari.



Electric heating units

Piastre elettriche
Elektro-Heizelemente
Corps de chauffe électriques
Calentadores eléctricos

art.	std	V-W
18341-KE	EU	220-60
18341-KU	US	110-170

Cm. Ø 13,5 - For ABS round ø cm 24.
Per scaldavivande ABS tondo ø cm 24.

DINING ROOM TROLLEYS CARRELLI SALA

BUFFET



PP

Serving trolley

Carrello servizio

Servierwagen

Chariot à servir

Carro de servicio

art. dim. cm. col.

49995-04 97x51x99 ●

Swivel casters for easy manoeuvrability. Ergonomic handles, high load capacity 135 kg (45 kg per shelf). Ultra-quiet mark-resistant casters. – Maniglie ergonomiche arrotondate, pannelli laterali e bordo paraurti arrotondato. Portata 135 kg (45 kg per ripiano). Ruote girevoli, antitraccia e silenziose.



NEW SERVICE CONCEPT



2-tier service trolleys with hygienic plexiglas dome cover double side opening and 4 standard swivel wheels, 2 with brake. A new way of serving food safely and fighting COVID 19 by clearly dividing the kitchen side and the service side to avoid contamination and have the most hygienic service possible.

Carrelli di servizio a 2 piani dotati di cupola igienica in plexiglas apribile sui 2 lati e 4 ruote girevoli di cui 2 con freno. Un nuovo modo di servire gli alimenti in sicurezza e combattere COVID 19 dividendo chiaramente il lato cucina e il lato servizio per evitare contaminazioni e avere il servizio più igienico possibile.



Serving trolley

Carrello servizio
Servierwagen
Chariot à servir
Carro de servicio

art. dim. cm.
49996-00 89x47x103

Chromed structure, shelves elm color, perimeter barrier lower deck, sliding plate shelf upper deck, wheels Ø 100 mm.

Struttura cromata, ripiani color olmo, spondine di contenimento piano inferiore, pianetto estraibile, ruote Ø 100 mm.



Serving trolley

Carrello servizio
Servierwagen
Chariot à servir
Carro de servicio

art. dim. cm.
49996-01 89x47x103

Chromed structure, shelves elm color, wheels Ø 100 mm.

Struttura cromata, ripiani color olmo, ruote Ø 100 mm.



Serving trolley

Carrello servizio
Servierwagen
Chariot à servir
Carro de servicio

art. dim. cm.
49996-05 89x47x103

Painted structure, shelves grey color, wheels Ø 100 mm.

Struttura verniciata, ripiani colore grigio, ruote Ø 100 mm.





A range of service tables and trolleys designed to allow guests to comfortably and safely receive and consume breakfast or dinner in their room. Hot boxes made of AISI 304 stainless steel with double insulated wall. Analog thermostat 30-90°C with indicator light. Equipped with two inner height-adjustable grids. Suitable for dishes up to Ø 32 cm. Refrigerated boxes made of AISI 304 stainless steel with double insulated wall with chilling pack -32°C inserted in a condensate collector basket placed on the upper grid. Chill for about 5 hours. Room service tables: chromes tube structure, 2 castors with brake. Top Ø 90 cm made of CDF (Compact Density Fibreboard). Can carry up to 2 boxes.

Una gamma di tavoli e carrelli per il servizio in camera per permettere agli ospiti di ricevere e consumare comodamente e in piena sicurezza la colazione o la cena in stanza. Box termici in acciaio inox AISI 304 a doppia parete coibentata. Termostato analogico 30-90°C con spia luminosa di funzionamento. Forniti con due griglie interne regolabili in altezza. Idonei per piatti fino a Ø 32 cm. Box refrigerati in acciaio inox AISI 304 a doppia parete coibentata. Refrigerazione a mezzo di una piastra eutettica -32°C inserita in un cesto di raccolta posizionato sulla griglia superiore. Raffreddare per c.ca 5 ore. Tavolini: struttura in tubo cromato, 2 ruote con freno. Piano Ø 90 cm in CDF (Compact Density Fibreboard). Possono trasportare fino a 2 box.



Thermic hot box

Box termico
Speisen-Kaste
Caisson thermique
Cajón térmico

art. dim. cm. W
44094-00 38x40,5x51,2 500

Refrigerated box

Box refrigerato
Speisen-Kaste
Caisson réfrigéré
Cajón refrigerado

art. dim. cm.
44094R00 38x40,5x51





Room service table

Tavolino room service
Zimmerservice-Tisch
Table de restauration en chambre
Carrito de servicio de habitaciones

art.	Ø cm.	h. cm.	closed/chiuso
44094-03	90/54,6	78,6	74x54x117

With fold down flaps for easy crossing of doors and lifts. With capsizable top for stacking when not in use. – Con flaps pieghevoli per attraversare porte e ascensori. Ribaltabile e impilabile quando non in uso.



Room service table with hot box

Tavolino room service con hot box
Zimmerservice-Tisch mit Hot Box
Table de restauration en chambre avec hot box
Carrito de servicio de habitaciones con hot box

art.	Ø cm.	h. cm.	W
44094-04	90/54,6	78,6	500

44094-00 + 44094-03.



Serving trolley

Carrello servizio
Servierwagen
Chariot à servir
Carro de servicio

art.	des.	dim. cm.
49996-01	trolley	89x47x103
44094-00	hot box	38x40,5x51,2
44094R00	cold box	38x40,5x51

With hygienic plexiglas dome cover double side opening. The trolley can be equipped with 2 hot and/or cold boxes. Ideal for maintaining the temperature of food and for the room service. – Cupola igienica in plexiglas apribile sui 2 lati. Il carrello è equipaggiabile con 2 box termici caldi e/o freddi. Ideale per mantenere la temperatura delle portate e per il servizio in camera.



Serving trolley

Carrello servizio
Servierwagen
Chariot à servir
Carro de servicio

art.	des.	dim. cm.
49996-05	trolley	89x47x103
44094-00	hot box	38x40,5x51,2
44094R00	cold box	38x40,5x51

With hygienic plexiglas dome cover double side opening. The trolley can be equipped with 2 hot and/or cold boxes. Ideal for maintaining the temperature of food and for the room service. – Con cupola igienica in plexiglas apribile sui 2 lati. Il carrello è equipaggiabile con 2 box termici caldi e/o freddi. Ideale per mantenere la temperatura delle portate e per il servizio in camera.



Breakfast tray with legs

Vassoio colazione con gambe
Frühstückstablett mit Beinen
Plateau petit déjeuner avec jambes
Bandeja desayuno con patas

art.	dim. cm.	col.
19902-38	58,5x38,5x30	●

Wengè.



Room service tray

Vassoio room service
Zimmerservice-Tablett
Plateau room-service
Bandeja room service

art.	dim. cm.	col.
19901-35	52x35	●
19901-40	60x40	●
19901-47	71x47	●

Dark walnut. – Noce scuro.

SERIES 14000

STORAGE & TRANSPORT
STOCCAGGIO E TRASPORTO



Molded in one-piece with double-wall construction made of polypropylene. Resistant to shock, high temperatures and chemicals. Designed to give optimum protection to glass and chinaware as well as to maximise water circulation and drying in professional dishwasher. Easy and quickly stackable without tools or screws. Base racks have comfortable hand grips on all four sides facilitating handling.

Realizzati in polipropilene, stampati unipezzo a doppio spessore. Resistenti agli urti ed alte temperature, agenti chimici e residui alimentari. Concepiti per assicurare una protezione ottimale a bicchieri e stoviglie, il loro design permette inoltre una perfetta circolazione dell'acqua di lavaggio ed una rapida e perfetta asciugatura. Facili e veloci da impilare. Leggeri e maneggevoli, tutti i cestelli di base sono dotati di maniglie integrali su tutti i lati.





9-Compartment base

Cestello 9 bicchieri
Grundkorb für 9 Gläser
Panier de base 9 verres
Cesta 9 compartimentos

art. mm.
14001-09 500x500x103

**Compartments / Scomparti 151x151x42 mm.
ø max 151 mm.**



9-Compartment extender

Estensore per cestello 9 bicchieri
Aufsatz zum Grundkorb für 9 Gläser
Réhausse pour panier de base 9 verres
Extensión 9 compartimentos

art. mm.
14003-09 500x500x45

**Compartments / Scomparti 151x151x88 mm.
ø max 151 mm.**



16-Compartment base

Cestello 16 bicchieri
Grundkorb für 16 Gläser
Panier de base 16 verres
Cesta 16 compartimentos

art. mm.
14001-16 500x500x103

**Compartments / Scomparti 112x112x88 mm.
ø max 112 mm.**



16-Compartment extender

Estensore per cestello 16 bicchieri
Aufsatz zum Grundkorb für 16 Gläser
Réhausse pour panier de base 16 verres
Extensión 16 compartimentos

art. mm.
14003-16 500x500x45

**Compartments / Scomparti 112x112x42 mm.
ø max 112 mm.**



25-Compartment base

Cestello 25 bicchieri
Grundkorb für 25 Gläser
Panier de base 25 verres
Cesta 25 compartimentos

art. mm.
14001-25 500x500x103

**Compartments / Scomparti 88x88x88 mm.
ø max 88 mm.**



25-Compartment extender

Estensore per cestello 25 bicchieri
Aufsatz zum Grundkorb für 25 Gläser
Réhausse pour panier de base 25 verres
Extensión 25 compartimentos

art. mm.
14003-25 500x500x45

**Compartments / Scomparti 88x88x42 mm.
ø max 88 mm.**

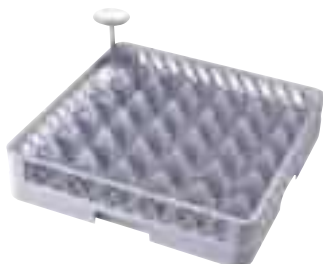

36-Compartment base

Cestello 36 bicchieri
Grundkorb für 36 Gläser
Panier de base 36 verres
Cesta 36 compartimentos

art. mm.
14001-36 500x500x103

**Compartments / Scomparti 73x73x88 mm.
ø max 73 mm.**



36-Compartment extender

Estensore per cestello 36 bicchieri
Aufsatz zum Grundkorb für 36 Gläser
Réhausse pour panier de base 36 verres
Extensión 36 compartimentos

art. mm.
14003-36 500x500x45

**Compartments / Scomparti 73x73x42 mm.
ø max 73 mm.**

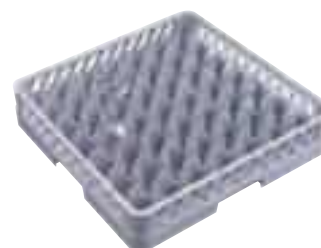

49-Compartment base

Cestello 49 bicchieri
Grundkorb für 49 Gläser
Panier de base 49 verres
Cesta 49 compartimentos

art. mm.
14001-49 500x500x103

**Compartments / Scomparti 62x62x42 mm.
ø max 62 mm.**



49-Compartment extender

Estensore per cestello 49 bicchieri
Aufsatz zum Grundkorb für 49 Gläser
Réhausse pour panier de base 49 verres
Extensión 49 compartimentos

art. mm.
14003-49 500x500x45

**Compartments / Scomparti 62x62x42 mm.
ø max 62 mm.**



Open extender

Estensore aperto
Universalrand ohne Einteilung
Réhausse sans cloisons
Extensión abierta

art. mm.
14004-00 500x500x42



Rack cover

Coperchio per cestelli
Deckel für Körbe
Couvercle à panier
Tapa para cestas

art. mm.
14011-00 505x505x25



Open rack

Cestello universale
Universal-Korb
Panier universel
Cesta universal

art. mm.
14010-00 500x500x103



Cutlery rack

Cestello per posate
Besteckkorb
Panier à couverts
Cesta para cubiertos

art. mm.
14006-00 500x500x103



Plates & trays rack

Cestello per piatti e vassoio
Tablett- u. Tellerkorb mit Fingern
Panier à plateaux et assiettes
Cesta para bandejas y platos

art. mm.
14008-00 500x500x103

For 18 flat plates or 9 trays max. 460 mm.
Per 18 piatti piani oppure 9 vassoio max. 460 mm.



Tray rack, open

Cestello per vassoio, aperto
Tablettkorb mit Fingern, offen
Panier à plateaux, ouvert
Cesta abierto para bandejas

art. mm.
14007-00 500x500x103

For trays over 460 mm. Capacity 9 pcs.
Per vassoio oltre 460 mm. Cap. 9 pz.

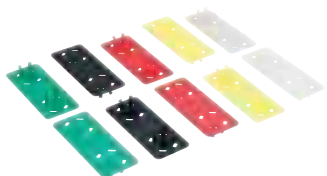

Clip tags, 10-pcs set

Etichette di identificazione, set 10 pz
Markierungsklipp, 10 Stk.
Clips, set 10 pièces
Etiquetas, set 10 piezas

art. mm.
14013-00 80x40



Cutlery holder 8 compartments

Cestello per posate 8 scomparti
Besteckkorb, 8 Unterteilungen
Panier à couverts 8 compartiments
Cesta para cubiertos

art. mm.
14015-08 426x206x150

For 200/250 pcs cutlery. – Per 200/250 posate.





SS

Cutlery holder

Cestello porta posate
Besteckbehälter
Réceptient à couverts
Cestillo para cubiertos

art.	Ø cm.	h. cm.
42586-10	10	14



PE

Cutlery holder

Cestello porta posate
Besteckbehälter
Réceptient à couverts
Cestillo para cubiertos

art.	Ø cm.	h. cm.
42586-09	9,5	13,5



PP

Cutlery dispenser

Porta posate
Besteckbehälter
Réceptient à couverts
Contenedor para cubiertos

art.	cm.
42585-06	54x33x13



PE

Cutlery dispenser

Porta posate
Besteckbehälter
Réceptient à couverts
Contenedor para cubiertos

art.	cm.	GN	h. cm.
42585-04	32,5x53	1/1	10



PP

Cutlery box lid

Coperchio per porta posate
Deckel für Besteckbehälter
Couvercle pour réceptient à couverts
Tapa para contenedor cubiertos

art.	cm.
42585-00	32,5x53x2

Fits/Per: 42585-04.



Dolly with handle

Carrello con maniglione
Transportwagen mit Griff
Chariot avec poignée
Carretilla con manillar

art.	cm.	Kg.
44023-00	54x54x75	10

Polypropylene base. – Base in PP.



Dolly without handle

Carrello senza maniglione
Transportwagen ohne Griff
Chariot sans poignée
Carretilla sin manillar

art.	cm.	Kg.
44024-00	54x54	8,5

Polypropylene base. – Base in PP.



Dolly, aluminum/ABS

Carrello, alluminio/ABS
Transportwagen, Aluminium/ABS
Chariot, aluminium/ABS
Carro, aluminio/ABS

art.	cm.
44975C50	51x51



SS

Dolly with handle

Carrello con maniglione
Transportwagen mit Griff
Chariot avec poignée
Carretilla con manillar

art.	cm.
44025-50	55x55x9

**Removable handle, with drip and drain plug.
Load 60 kg. – Manico estraibile, tappo di scarico.
Carico 60 kg.**



Dust cover

Copertura protettiva
Schutzhülle
Housse de protection
Cuberta protectora

art.	cm.
44009-00	55x55x122



Trolley 3 levels

Carrello 3 livelli
3-stöckiger Wagen
Chariot à 3 étages
Carro 3 pisos

art.	cm.
44020-21	100x50x178,5

Suitable for 24 racks.
Carico verticale per 24 cestelli.

SS



PP

Multipurpose box

Recipiente
Behälter
Conteneur multiservice
Contenedor

art.	cm.
44031-04	52x39x12,7
44031-05	52x39x17,7



SS

Wall draining rack

Scolapiatti a muro
Wand-Trockengestell
Egouttoir au mur
Escurridor mural de platos

art.	cm.
44029-00	87x30x20

Load/Carico: 70 kg.



Wire dish rack

Porta piatti in filo metallo/rilsan
Tellergestell
Porte-assiettes
Porta platos

art.	Ø cm.	h. cm.
44047-17	17	30
44047-19	19	30
44047-22	22	30
44047-25	25	30
44047-28	28	30



SS

Dish dolly

Carrello portapiatti
Teller-Transportwagen
Chariot porte-assiettes
Carro porta platos

art.	cm.
44027-00	74x61x81

Load/Carico max: 240 kg.



PE

Adjustable dish dolly

Carrello portapiatti regolabile
Teller-Transportwagen, einstellbar
Chariot de stockage d'assiettes réglable
Carro ajustable para platos

art.	cm.	Kg.
49304-06	73x73x82	28

With dust cover and 4 dividers. Dishes Ø cm 18-32,5 capacity 180/480 pcs. 2 wheels with brake.
Con copertura vinilica e 4 divisori. Per piatti Ø cm 18-32, capienza 180/480 pz. 2 ruote con freno.

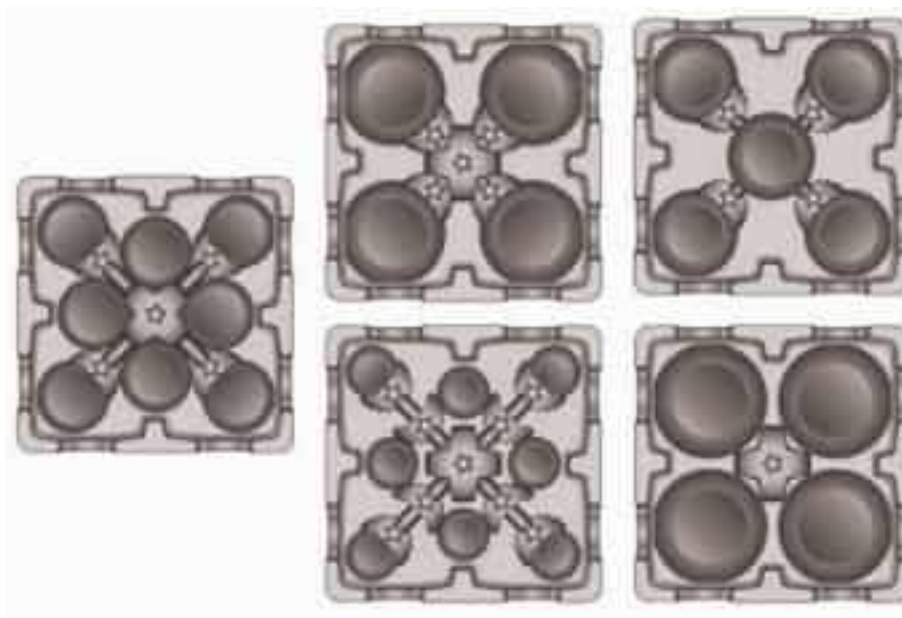

CROCKERY TRANSPORT BOX
CONTENITORE PER IL TRASPORTO DI STOVIGLIE

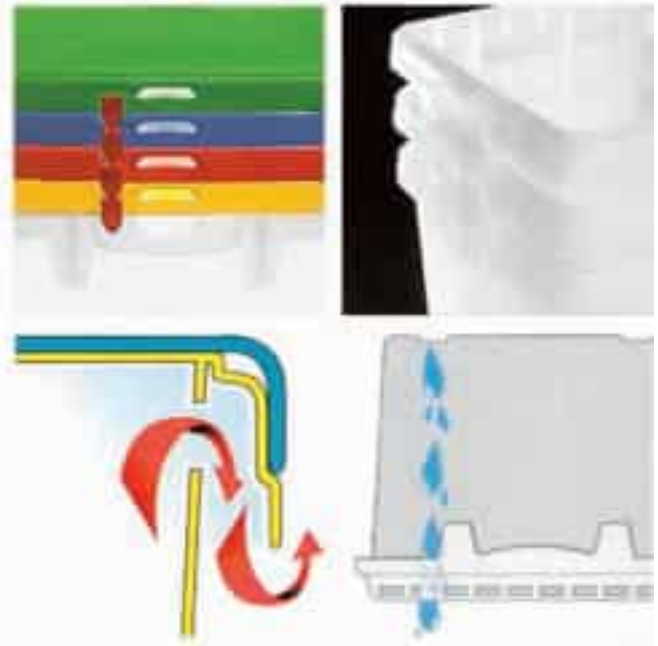

Clear polypropylene construction, full compliance with food contact requirements. A removable tower insert provides total flexibility. Strong, it prevents dish breakage in transport. Dimensions suitable to EURO-pallets. Lids are tightly fitting, hygienic, dish-washer safe. Covers available in different colors, assure easy and quick content identification. Stackable once empty, their strongness provides high loading density once full. Ventilation holes assure constant air circulation. Design studied to enable water flow while washing.

Contenitori in polipropilene trasparente per alimenti. Estremamente resistenti alle sollecitazioni, offrono protezione sicura nel trasporto. Dimensioni adatte a EURO-pallets. Adatti al lavaggio in lavastoviglie, design studiato per consentire il defluire dell'acqua. Coperchi di colore diverso facilitano l'individuazione del contenuto. Impilabili, a pieno la loro robustezza consente un'elevata capacità di sovrapposizione. Fessure di aerazione per un costante ricambio d'aria.



Storage box
Contenitore
Korb
Panier
Contenedor

art.	cm.	lt.
44040-40	40x40x31,5	32



Base insert
Fondo piatto
Flach-Einsatz
Plateau double fond
Base plana

art.	cm.
44042-00	40x40



Cross insert
Inserto croce
Kreuz-Einsatz
Cloison à croix
Separador a cruz

art.	cm.
44043-00	40x40



Cover
Coperchio
Deckel
Couvercle
Tapa

art.	col.
44041-00	○
44041-01	●
44041-03	●



Cover
Coperchio
Deckel
Couvercle
Tapa

art.	col.
44041-04	●
44041-05	●



Tower insert
Tubo fermapiatti
Rohr-Einsatz
Tuyau
Tubo

art.
44044-00

SQUARE FOOD STORAGE CONTAINERS
CONTENITORI QUADRATI PER LA CONSERVAZIONE
DEGLI ALIMENTI



Space-saving **SQUARE & ROUND** containers. In clear polycarbonate to identify the contents. Smooth interior finish with spoonable bottom helps prevent food waste, making clean-up easy. Printed measurements. Wide handles and drain holes for easy grip and quick drying. Stacking lugs. Tight fitting lids with hang hole. They withstand temperatures between **-40°C and 100°C**.

Contenitori **QUADRATI & ROTONDI** salvaspazio. In polycarbonato trasparente per identificare il contenuto. La finitura interna liscia con fondo con angoli arrotondati previene lo spreco di cibo e facilita la pulizia. Misurazioni stampate. Impugnatura ampia e maneggevole con fori di drenaggio per una rapida asciugatura. Alette impilabili. Coperchi ermetici con foro per appendere. Resistono a temperature comprese tra **-40°C e 100°C**.



Food container

Contenitore per alimenti
Vorratsdosen
Conteneur pour aliments
Contenedor para alimentos

art.	cm.	lt.
44628-02	18x18x9,6	1,9
44628-04	18x18x18,5	3,8
44628-06	22x22x18,6	5,7
44628-08	22x22x22,8	7,6



Food container

Contenitore per alimenti
Vorratsdosen
Conteneur pour aliments
Contenedor para alimentos

art.	cm.	lt.
44628-11	28,3x28,3x21	11,4
44628-17	28,3x28,3x32	17,0
44628-20	28,3x28,3x40	20,8



PE

Square lid

Coperchio quadrato
Deckel, viereckig
Couvercle carré
Tapa cuadrada

art.	cm.	lt.	col.
44628-21	18,5x18,5x1,6	1,9-3,8	●
44628-22	22,8x22,8x1,6	5,5-7,6	●
44628-23	28,9x28,9x1,6	11,4-20,8	●





NEW

Food container

Contentitore per alimenti
Vorratsdosen
Conteneur pour aliments
Contenedor para alimentos

art.	Ø cm.	h. cm.	lt.
44629-03	22	19,5	5,7
44629-04	22	27,0	7,8
44629-05	31	20,5	11,4
44629-06	31	30,0	17,0
44629-07	31	38,0	21,0

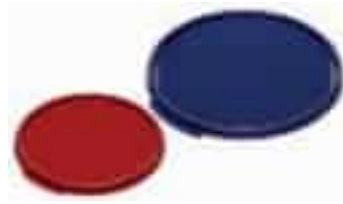

NEW

PE

Round lid

Coperchio rotondo
Deckel, rund
Couvercle rond
Tapa redonda

art.	Ø cm.	col.
44629-R4	22	●
44629-B7	31	●



PC

Food container

Contentitore per alimenti
Nahrungsmittel-Behälter
Conteneur pour aliments
Contenedor para alimentos

art.	cm.	lt.
49384-03	45,7x30x23	19,0
49384-04	45,7x66x9	19,0
49384-05	45,7x66x15	32,3
49384-07	45,7x66x38	81,5



PC

Drain tray

Vasca di drenaggio
Abtropf-Behälter
Conteneur perforé
Contenedor para colar

art.	cm.
49384-11	45,7x66x12

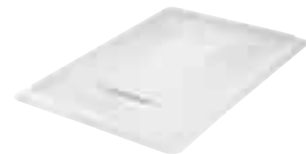

PC

Lid

Coperchio
Deckel
Couvercle
Tapa

art.	cm.
49384-14	45,7x30
49384-15	45,7x66



PP

Food container with lid

Contentitore per alimenti c/cop
Nahrungsmittel-Behälter mit Deckel
Conteneur pour aliments avec couvercle
Contenedor para alimentos con tapa

art.	cm.	lt.
44046-20	38x28x30	20
44046-40	58x38x26	40
44046-60	58x38x38	60



PP

Food container

Contentitore per alimenti
Nahrungsmittel-Behälter
Conteneur pour aliments
Contenedor para alimentos

art.	mm.	lt.
49383-08	310x375x215	8
49383-20	280x595x430	20
49383-40	480x630x430	40



PP

Food storage mobile bin

Carrello per derrate alimentari
 Fahrbares Nahrungsmittelbehälter
 Chariot mobile de stockage
 Contenedor móvil para alimentos

art.	mm.	lt.
49380-80	333x743x711	81



PP

Food storage mobile bin

Carrello per derrate alimentari
 Fahrbares Nahrungsmittelbehälter
 Chariot mobile de stockage
 Contenedor móvil para alimentos

art.	cm.	lt.
49381-01	74x33,5x71	79,0
49381-02	75x39,5x71	97,5
49381-03	75,5x45,5x71	116



HDPE

Container with handles

Contentitore con maniglie
 Behälter mit Griffen
 Conteneur avec poignées
 Contenedor con asas

art.	Ø cm.	h. cm.	lt.
49372-01	39	41	35
49372-02	45	47	50
49372-03	49	57	75
49372-04	52	67	100



HDPE

Lid with handles

Coperchio con maniglia
 Deckel mit Griff
 Couvercle avec poignée
 Tapa con asa

art.	Ø cm.
49372-11	39
49372-12	45
49372-13	49
49372-14	52



PP

Trolley

Supporto mobile
 Wagen
 Chariot
 Soporte móvil

art.	cm.
49372-24	53,2x53,2x24,7

For containers Lt. 75 and 100. Four wheels, two with blocking mechanism. – Per contenitori Lt. 75 e 100. Quattro ruote di cui 2 con meccanismo di bloccaggio.



HDPE

Container without handles

Contentitore senza maniglie
 Behälter ohne Griffen
 Conteneur sans poignées
 Contenedor sin asas

art.	Ø cm.	h. cm.	lt.
49372-05	61	70	150
49372-06	67	80	200



HDPE

Lid

Coperchio
 Deckel
 Couvercle
 Tapa

art.	Ø cm.
49372-15	61
49372-16	67



SS

Sink trolley

Carrello vasca
 Obst/Gemüsewaschwagen
 Chariot à évier
 Carro-cuba lavado verduras

art.	cm.	lt.
44028-19	80x60x75	190

Tub with tap, brushed finish. Stamped bottom watertight, without edges. – Vasca con rubinetto, finitura spazzolata. Fondo stampato a tenuta stagna, privo di spigoli.



PE

Bread basket

Cesto pane
Brot-Korb
Corbeille à pain
Cesta pan

art.	cm.	lt.
44982-04	57x36x34	40
44982-06	66x45x35	60
44982-10	78x52x40	100



PP

Space saving box

Contenitore salvaspazio
Behälter
Récipliant
Contenedor

art.	des.	cm. ext.
44033B23	box	66x45x23
44033B38	box	66x45x38,5
44033A23	lid/cop	67x46x2



PP

Gastronorm basket

Cesto gastronorm
Gastronorm-Korb
Panier gastronorme
Cesta gastronorm

art.	cm. ext.
44034-11	59,5x39x19

STACKABLE CONTAINERS
CONTENITORI SOVRAPPONIBILI



Stackable containers, external dimensions 600x400 mm and 400x300 mm, they perfectly fit to 800x1200 mm EUR pallets and to 1000x1200 mm. Available in different heights and versions. High density polyethylene HDPE. A thermoplastic that offers excellent impact resistance at low temperatures (from -30°C to +70°C).

Contenitori sovrapponibili con dimensioni esterne di mm 600x400 e 400x300 perfettamente pallettizzabili su pallett EUR mm 800x1200 e 1000x1200. Disponibili in diverse altezze e versioni. Polietilene alta densità HDPE. Uno dei materiali termoplastici più dotato di resistenza all'impatto con basse temperature (da -30°C a +70°C).



Container
Contenitore
Behälter
Conteneur
Contenedor

art.	cm.	lt.
44511E21	60x40x10	21
44511E63	60x40x32	63
44511E90	60x40x45	90

Solid bottom and sides. – Fondo e pareti chiuse.



Container
Contenitore
Behälter
Conteneur
Contenedor

art.	cm.	lt.
44512E12	60x40x7	12
44512E21	60x40x10	21

Solid bottom and perforated sides.
Fondo chiuso e pareti forate.



Container
Contenitore
Behälter
Conteneur
Contenedor

art.	cm.	lt.
44513E12	60x40x7	12
44513E21	60x40x10	21

Perforated bottom and sides.
Fondo e pareti forate.



PP

Lid
Coperchio
Deckel
Couvercle
Tapa

art.	cm.
41763-00	60x40x2



PP

Lid
Coperchio
Deckel
Couvercle
Tapa

art.	cm.
41763-30	40x30x2



Container
Contentitore
Behälter
Conteneur
Contenedor

art.	cm.	lt.
44521E10	40x30x12	10

Solid bottom and sides. – Fondo e pareti chiuse.



Container
Contentitore
Behälter
Conteneur
Contenedor

art.	cm.	lt.
44521-16	40x30x17	16
44521-21	40x30x22	21
44521-31	40x30x32	31

Solid bottom and sides. – Fondo e pareti chiuse.



Container
Contentitore
Behälter
Conteneur
Contenedor

art.	cm.	lt.
44511-27	60x40x15	27
44511-34	60x40x17	34
44511-38	60x40x20	38
44511-42	60x40x22	42
44511-63	60x40x32	63
44511-90	60x40x45	90

Solid bottom and sides. – Fondo e pareti chiuse.



Container
Contentitore
Behälter
Conteneur
Contenedor

art.	cm.	lt.
44522E10	40x30x12	10

Solid bottom and perforated sides.
Fondo chiuso e pareti forate.



Container
Contentitore
Behälter
Conteneur
Contenedor

art.	cm.	lt.
44522-16	40x30x17	16
44522-21	40x30x22	21
44522-31	40x30x32	31

Solid bottom and perforated sides.
Fondo chiuso e pareti forate.



Container
Contentitore
Behälter
Conteneur
Contenedor

art.	cm.	lt.
44512-34	60x40x17	34
44512-42	60x40x22	42
44512-63	60x40x32	63
44512-90	60x40x45	90

Solid bottom and perforated sides.
Fondo chiuso e pareti forate.



Container
Contentitore
Behälter
Conteneur
Contenedor

art.	cm.	lt.
44513-34	60x40x17	34
44513-38	60x40x20	38
44513-54	60x40x29	54
44513-63	60x40x32	63
44513-90	60x40x45	90

Perforated bottom and sides.
Fondo e pareti forate.





Made of expanded polypropylene (PPE), suitable for protecting food from thermal stress thanks to the insulating properties of the expanded polymer which guarantees a thermal drop compliant with the UNI EN 12571:1999 standard. Polypropylene is expanded with CO₂, without CFCs and HCFCs, and has no residual blowing agents. It has a closed cell structure which gives it excellent characteristics of energy dissipation in impacts and specific thermal resistance. Expanded Polypropylene is mainly composed of air (in relation to density it can reach 98% of air) and only 2% of pure hydrocarbon structural material, it is 100% recyclable and in infinite cycles without releasing residues into the environment or losing its chemical-physical characteristics.

Realizzati in polipropilene espanso (PPE), idonei a proteggere gli alimenti da sollecitazioni termiche grazie alle proprietà coibentanti del polimero espanso che garantisce una caduta termica conforme alla norma UNI EN 12571:1999. Il polipropilene è espanso con CO₂, senza CFC e HCFC, e non ha agenti di espansione residui. Ha una struttura a celle chiuse che gli conferisce eccellenti caratteristiche di dissipazioni di energia negli urti e di resistenza termica specifica. Il Polipropilene Espanso è composto prevalentemente da aria (in relazione alla densità può raggiungere il 98% di aria) e solo dal 2% di materiale strutturale di puro idrocarburo, è riciclabile al 100% e a cicli infiniti senza rilascio di residui nell'ambiente o perdita di caratteristiche chimico-fisiche.



NEW

Insulated GN container SMARTHEATER

Contenitore isotermico
Thermobehälter
Conteneur isotherme
Contenedor isotérmico

art.	cm. ext.	int.	GN	lt.
44983-01	40,6x60,5x37,6	34x54x26,7	1/1	49

Power outlet on the back of the container. Operating temperature -40 +120°C. 220-240V. 50 Hz. 100W. (Resistance) 65°C. Capacity: 2 x GN 1/1 100 mm. or submultiples. – Presa corrente su retro contenitore. Temperatura di esercizio -40 +120°C. 220-240V. 50 Hz. 100W. (Resistenza) 65°C. Capacità: 2 x GN 1/1 100 mm. o sottomultipli.





NEW

Insulated GN container SMARTHEATER

Contentitore isothermico
Thermobehälter
Conteneur isotherme
Contenedor isotérmico

art.	cm. ext.	int.	GN	lt.
44983-02	50x65x61	33x54x48	1/1	83

Power outlet on the back of the container. Operating temperature -40 +120°C. 220-240V. 50 Hz. 165W. (Resistance) 65°C. Capacity: 2 x GN 1/1 200 mm. or submultiples. – Presa corrente su retro contenitore. Temperatura di esercizio -40 +120°C. 220-240V. 50 Hz. 165W. (Resistenza) 65°C. Capacità: 2 x GN 1/1 200 mm. o sottomultipli.



NEW

Insulated container SMARTHEATER

Contentitore isothermico
Thermobehälter
Conteneur isotherme
Contenedor isotérmico

art.	cm. ext.	int.	lt.
44983-03	60x72x63	40x60x50	128

Power outlet on the back of the container. Operating temperature -40 +120°C. 220-240V. 50 Hz. 165W. (Resistance) 65°C. Capacity: 9 trays 60x40 mm. Presa corrente su retro contenitore. Temperatura di esercizio -40 +120°C. 220-240V. 50 Hz. 165W. (Resistenza) 65°C. Capacità: 9 vassoi 60x40 mm.



Insulated container UNIVERSAL PN

Contentitore isothermico
Thermobehälter
Conteneur isotherme
Contenedor isotérmico

art.	cm.	h.	lt.
44986-17	61x43	25,0	33,8
44986-21	61x43	29,5	42,8
44986-28	61x43	36,5	56,7

Dim. int cm. 54,5x36,5x17 /x21,5 /x28,5.



Insulated container GN 1/2

Contentitore isothermico
Thermobehälter
Conteneur isotherme
Contenedor isotérmico

art.	cm.	h.	lt.
44972-20	41,5x32	28,5	20,3
44972-25	41,5x32	32,0	21,6
44972-33	41,5x32	40,0	31,2

Dim. int cm. 35x27x21,5 /x25 /x33.



Insulated container GN 1/1

Contentitore isothermico
Thermobehälter
Conteneur isotherme
Contenedor isotérmico

art.	cm.	h.	lt.
44970-10	60x40	17	20,2
44970-15	60x40	23	31,2

Dim. int cm. 54x34x11 /x17.





Insulated container GN 1/1

Contentitore isotermico
Thermobehälter
Conteneur isotherme
Contenedor isotérmico

art.	cm.	h.	lt.
44970-20	60x40	27	38,6
44970-34	60x40	34	52,3

Dim. int cm. 54x340x21 /x28.



Insulated container PLUS GN 1/1

Contentitore isotermico
Thermobehälter
Conteneur isotherme
Contenedor isotérmico

art.	cm.	h.	lt.
44978-20	68x44,5	30	45,6

Dim. int cm. 56x37x22.



Insulated pastry container

Contentitore isotermico pasticceria
Konditorei-Thermobehälter
Conteneur isotherme à pâtisserie
Contenedor isotérmico para pastelería

art.	cm.	h.	lt.
44974-21	68,5x48,5	27	55,8
44974-27	68,5x48,5	33	71,7
44974-31	68,5x48,5	37	82,3

Dim. int cm. 62,5x42,5x21 /x26 /x31.



Insulated container HANDTOP

Contentitore isotermico
Thermobehälter
Conteneur isotherme
Contenedor isotérmico

art.	cm.	h.	lt.
44961-06	71,5x40	31,5	45

Dim. int cm. 55x34x24. Incorporated ergonomic handles. For GN 1/1. – Maniglie ergonomiche incorporate. Trasporta GN 1/1.



Insulated container TROLLEYBOX

Contentitore isotermico
Thermobehälter
Conteneur isotherme
Contenedor isotérmico

art.	cm.	h.	lt.
44961-04	42x42	60	60

Dim. int cm. 36x36x46.



Insulated container BOXSHOP

Contentitore isotermico
Thermobehälter
Conteneur isotherme
Contenedor isotérmico

art.	cm.	h.	lt.
44961-02	41,5x32	32	21,6

Dim. int cm. 35x27x25



Insulated container PIZZABOX

Contentitore isotermico
Thermobehälter
Conteneur isotherme
Contenedor isotérmico

art.	cm.	h.	lt.
44961-03	42x42	34,5	36

Dim. int cm. 36x36x28. With steam release system. – Con sistema di rilascio del vapore.



Insulated container PORTER GN 1/1

Contentitore isotermico
Thermobehälter
Conteneur isotherme
Contenedor isotérmico

art.	cm.	h.	lt.
44987-11	65x50	61	83

Dim. int cm. 54x33x48. For GN 1/1. 12 slides. Per GN 1/1. 12 guide.



Insulated container PORTER MAXI

Contentitore isotermico
Thermobehälter
Conteneur isotherme
Contenedor isotérmico

art.	cm.	h.	lt.
44987-60	72x60	63	128

Dim. int cm. 60x40x50. For pastry trays 60x40. 9 slides. – Per teglie 60x40. 9 guide.



Insulated container GN CRYSTAL

Contentitore isotermico
Thermobehälter
Conteneur isotherme
Contenedor isotérmico

art.	cm.	h.	lt.
44968-00	60x40	30	45,4

Dim. int cm. 54x34x24. Inside crystallized and therefore perfectly smooth, rigid and waterproof.
Interno cristallizzato perfettamente liscio, rigido e impermeabile.



Dolly, aluminum/ABS

Carrello, alluminio/ABS
Fahrgestell, Aluminium/ABS
Chariot, aluminium/ABS
Carro, aluminio/ABS

art.	cm.	for/per
44975C50	58,5x58,5	44975-50
44987C11	68x52	44987-11
44987C60	75x61	44987-60
44987C62	62x42	44968&44970



Eutectic pad

Accumulatore di freddo
Kühlakku
Cartouche eutectique
Placa eutética

art.	cm.	GN
44979-04	32,5x26,5x3	1/2
44979-05	53x32,5x3	1/1
44979-06	60x40x3	-

Temp. 0/-21°C.



Heat accumulator

Accumulatore di caldo
Wärmespeicher
Accumulateur de chaleur
Acumulador de calor

art.	cm.	GN
44979-02	53x32,5x3	1/1

Temp. 0/+65°C.



Insulated box

Box isotermico
Thermobehälter
Conteneur isotherme
Contenedor individual isotérmico

art.	cm.	h.
44976-04	44x38	12

3 sections for dishes ø 12 h 6 cm or 16x16 cm.
3 vani per piatti ø 12 h 6 cm o 16x16 cm.



Insulated box DOMUS

Box isotermico
Thermobehälter
Conteneur isotherme
Contenedor individual isotérmico

art.	cm.	h.
44976-02	42,5x26,5	16,5

2 sections for dishes 18x18 cm.
2 vani per piatti 18x18 cm.



Insulated box MONOKING

Box isotermico
Thermobehälter
Conteneur isotherme
Contenedor individual isotérmico

art.	cm.	h.
44976-01	48,5x35	16

2 insulated sections for dishes size 18x18 cm.
2 vani coibentati per piatti 18x18 cm.



Insulated box THERMOKING

Box isotermico
Thermobehälter
Conteneur isotherme
Contenedor individual isotérmico

art.	cm.	h.
44976-03	47x37	18,5

Release latch lid. Usefull height 11,5 cm.
Coperchio a incastro. Altezza utile 11,5 cm.



Food container

Pietanziera
Speisenbehälter
Porte-manger
Contenedor comida

art.	Ø cm.	h. cm.
44977-12	12	6

SS



MODULAR SYSTEM BASE=LID EXTENSIBLE HEIGHT
SISTEMA MODULARE BASE-COPERCHIO ALTEZZA ESTENSIBILE



Modular system, the base and lid are the same element and due to the extender insert it is possible to increase capacity. Equipped with rotation system that allows steam to escape.

Sistema modulare, base e coperchio sono lo stesso elemento e grazie all'inserto estensore è possibile aumentare la capacità. Provvisto di sistema rotabile, per la fuoriuscita del vapore.



Base and lid

Base e coperchio
Basis und Abdeckung
Base et couvercle
Base y tapa

art.	cm. ext.	int.
44975-50	57x57x9,5	51x51x6,3



Extender

Estensore
Aufsatz
Réhausse
Extensión

art.	cm. ext.	int.
44975H50	57x57x9,5	51x51x7,5x9,5



NEW
PE

Insulated container GN 1/1
Contentitore isothermico GN 1/1
Thermobehälter GN 1/1
Conteneur isotherme GN 1/1
Contenedor isotérmico GN 1/1

art.	cm. ext.	int.	Kg.
44937-01	68x46x74	53x35x50	21

LLDPE and polyurethane. Keeps food hot or cold up to 6+ hours. Stackable. – LLDPE e poliuretano. Mantiene il cibo caldo o freddo fino a 6 ore. Impilabile.



NEW
PE

Dolly
Carrello
Fahrgestell
Chariot
Carro

art.	cm.	Kg.
44937-02	68x48x25	6,58

LLDPE. Omnidirectional casters. LLDPE. Ruote omnidirezionali.





Insulated container GN 1/1
 Contenitore isotermico GN 1/1
 Thermobehälter GN 1/1
 Conteneur isotherme GN 1/1
 Contenedor isotérmico GN 1/1

art.	cm.	lt.
44932-15	61x41x25	24,6
44932-20	61x41x30	31,1



Insulated container GN 1/1
 Contenitore isotermico GN 1/1
 Thermobehälter GN 1/1
 Conteneur isotherme GN 1/1
 Contenedor isotérmico GN 1/1

art.	cm.	lt.
44934-30	44x64x48	63



Insulated beverage dispenser
 Distributore di bevande isotermico
 Isolierte Getränkebehälter
 Conteneur isotherme avec robinet
 Contenedor isotérmico con grifo

art.	cm.	lt.
44930-10	24x43x43	10
44930-20	30x46x46	20



PE

Ice cart
 Carrello porta ghiaccio
 Eiswaagen
 Chariot à glace
 Carro hielo

art.	cm.
44936-01	71x56,5x73

Load/Carico: 57 kg.



Ice scoop with holder
 Pala ghiaccio con supporto
 Eisschaufel mit Träger
 Pelle à glace avec support
 Librador hielo con soporte

art.	cm.	lt.
44936-22	61,5x47x25,4	2,5

BPA Free.



Ice bucket
 Secchio ghiaccio
 Eiseimer
 Seau à glace
 Cubo hielo

art.	cm.	lt.
44936-25	34x30x46	22,7

BPA Free.

JACKSTACK

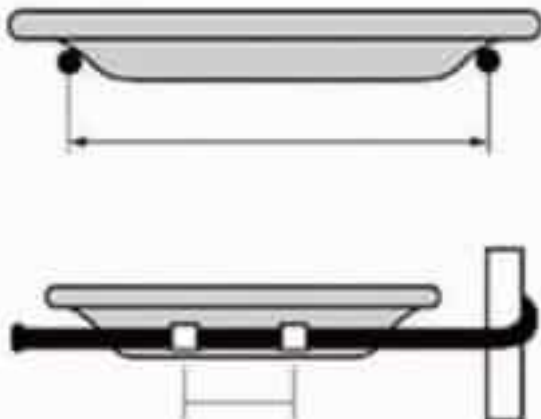

Welded steel construction. Black electrostatic powder coating. Quick set assembly in minutes. Quick-change to any plate size (max ø cm 30, kg 3 each). Length of plate support 17 cm, spacing 5 cm.

Struttura in acciaio saldato. Rivestimento nero elettrostatico. Assemblaggio veloce. Adattabile ad ogni misura di piatto (ø max cm 30, kg 3). Lunghezza bracci 17 cm, distanza 5 cm.





Mobile plate rack

Carrello porta piatti
Fahrbares Tellergestell
Chariot porte-assiettes mobile
Carrito para almacenaje de platos

art. cm.
44830-99 60x60X179

For pcs/Per pz 104

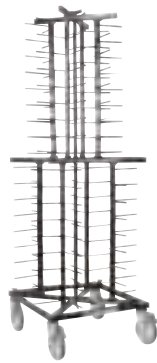

Mobile plate rack

Carrello porta piatti
Fahrbares Tellergestell
Chariot porte-assiettes mobile
Carrito para almacenaje de platos

art. cm.
44830-72 60x60X180

For pcs/Per pz 72

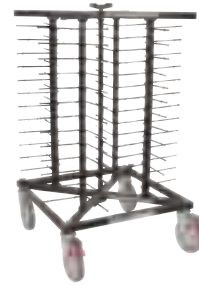

Mobile plate rack

Carrello porta piatti
Fahrbares Tellergestell
Chariot porte-assiettes mobile
Carrito para almacenaje de platos

art. cm.
44830-52 60x60x103

For pcs/Per pz 52

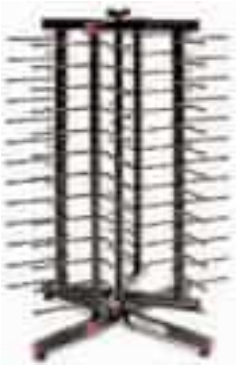

Swivelling table top rack

Porta piatti rotante
Drehbares Tischgestell
Porte-assiettes de table pivotant
Soporte para almacenaje de platos

art. cm.
44831-52 48x48x89

For pcs/Per pz 52



Zippered plastic cover

Copertura in plastica
Plastik Schutzhülle
Housse en plastique
Cubre carrito, plástico

art. for/per
44832-99 44830-72/44830-99



Thermo cover

Copertura termica
Thermo-Hülle
Thermo-housse
Cubre carrito, térmico

art. for/per
44833-99 44830-72/44830-99



Thermic hot box

Box termico
Speisen-Kaste
Caisson thermique
Cajón térmico

art. cm. W
44094-00 38x40,5x51,2 500

Stainless steel box with double insulated wall. Analogic thermostat 30-90°C.
– Box in acciaio inox a doppia parete coibentata. Termostato analogico 30-90°C.



Refrigerated box

Box refrigerato
Speisen-Kaste
Caisson réfrigéré
Cajón refrigerado

art. cm.
44094R00 38x40,5x51

Stainless steel box with double insulated wall with chilling pack -32°C. – Box in acciaio inox a doppia parete coibentata. Refrigerazione a mezzo di una piastra eutettica -32°C.



Table with hot box

Tavolino con box termico
Tisch mit Hot Box
Table avec hot box
Carrito con hot box

art.	Ø cm.	h. cm.	W
44094-04	90/54,6	78,6	500

Table with fold down flaps. With capsizable top for stacking when not in use.

Tavolo con flaps pieghevoli. Ribaltabile e impilabile quando non in uso.

Fast food tray

Vassoio fast food
Serviertablett, Fast Food
Plateau fast food
Bandeja fast food

art.	cm.
41860-36	27x36,5
41860-43	30,7x43,5
41860-47	35,5x47



Fast food tray

Vassoio fast food
Serviertablett, Fast Food
Plateau fast food
Bandeja fast food

art.	cm.
41861-44	30,7x44



Gastronorm tray

Vassoio Gastronorm
Serviertablett, Gastronorm
Plateau Gastronorm
Bandeja Gastronorm

art.	cm.	col.
41862B11	53x32,5x1,6	●
41862C11	53x32,5x1,6	●
41862G11	53x32,5x1,6	●



Euronorm tray

Vassoio Euronorm
Serviertablett, Euronorm
Plateau Euronorm
Bandeja Euronorm

art.	cm.	col.
41862B53	53x37x1,6	●
41862C53	53x37x1,6	●
41862G53	53x37x1,6	●



Universal tray collector trolley

Carrello ritiro vassoi universale
Tablettabräumwagen Universal
Chariot débarrassage plateaux universel
Carro porta bandeja universal

art.	cm.
44803-10	47x55x153
44803-20	88x55x153

12 cm between shelves. 4 swivel wheels 100 mm. Chrome-plated steel thread supports 6 mm.
Distanza fra piani 12 cm. 4 ruote girevoli 100 mm. Supporti in filetto acciaio cromato 6 mm.



Universal tray collector trolley

Carrello ritiro vassoi universale
Tablettwagen Universal
Chariot débarrassage plateaux universel
Carro porta bandeja universal

art.	cm.
44803-30	129x55x153

They can hold trays in different sizes (width ranging from 300 to 370 mm) including Euronorm and Gastronorm. – Possono accogliere vassoi di varia misura (larghezza tra 300 e 370 mm) inclusi Euronorm e Gastronorm.



Disposable covers, 200 pcs

Coperture monouso, 200 pezzi
Einweg-Schutzhüllen, 200 Stk.
Housses usage unique, 200 pcs
Cubrecajitos desechables, 200 pz

art.	for/per	h. cm.
42512-91	GN 1/1	180
42512-92	GN 2/1	180
	60x40	180





SS

Roll holder
Porta rotolo
Rollenhalter
Dérouleur mural
Portarollos

art. cm.
42512-90 90x23x19



SS

Utility rack GN 2/1
Carrello GN 2/1
2/1 GN-Behälterwagen
Chariot GN 2/1
Carro GN 2/1

art. cm.
44807-28 60x70x153,5

Welded structure, 28 rails, 4 wheels, 2 with brakes. – Struttura saldata, 28 guide, 4 ruote girevoli di cui 2 con freno.



SS

Utility rack GN 2/1
Carrello GN 2/1
2/1 GN-Behälterwagen
Chariot GN 2/1
Carro GN 2/1

art. cm.
44807-36 73x62x171

To be assembled, 18 rails, accomodates GN pans height 65 mm. Load max 300 kg. – Fornito smontato, 18 guide, accoglie GN di h. 65 mm. Carico max 300 kg.



SS

Utility rack GN 1/1
Carrello GN 1/1
1/1 GN-Behälterwagen
Chariot GN 1/1
Carro GN 1/1

art. cm.
44807-18 38x62x164

To be assembled, 18 rails, accomodates GN pans height 65 mm. Load max 150 kg. – Fornito smontato, 18 guide, accoglie GN di h. 65 mm. Carico max 150 kg.



SS

Utility rack GN 1/1
Carrello GN 1/1
1/1 GN-Behälterwagen
Chariot GN 1/1
Carro GN 1/1

art. cm.
44801-09 38x62x94,5

To be assembled, 9 rails, accomodates GN pans height 65 mm. Load max 75 kg. – Fornito smontato, 9 guide, accoglie GN di h. 65 mm. Carico max 75 kg.



SS

Baking sheet trolley
Carrello porta teglie
Backbleche-Wagen
Chariot pour plaques
Carro porta placas

art. cm.
44826-00 52x72x85

Pitch 7,5 cm. For 60x40 cm trays. S/steel top. Swivel castors ø 9,5 cm, 2 with brakes. – Passo 7,5 cm. Per teglie cm 60x40. Piano superiore inox. Ruote piroettanti ø cm 9,5 di cui 2 con freno.



SS

Serving trolley
Carrello di servizio
Mehrzweckwagen
Chariot de service
Carrito para desocupar

art. cm.
44819-02 91x59x93

To be assembled, 4 swivel castors, 2 with brakes. Load max 80 kg. – Fornito smontato, 4 ruote girevoli di cui 2 con freno. Carico max 80 kg.



SS

Serving trolley
Carrello di servizio
Mehrzweckwagen
Chariot de service
Carrito para desocupar

art. cm.
44819-03 91x59x93

To be assembled, 4 swivel castors, 2 with brakes. Load max 120 kg. – Fornito smontato, 4 ruote girevoli di cui 2 con freno. Carico max 120 kg.



SS

Serving trolley
Carrello di servizio
Mehrzweckwagen
Chariot de service
Carrito para desocupar

art. cm.
44820-80 80x50x93,5
44820-99 100x50x93,5

To be assembled, 4 swivel castors, 2 with brakes. Max load per shelf kg 30. – Fornito smontato, 4 ruote girevoli di cui 2 con freno. Portata max. per ripiano kg 30.



SS

Serving trolley

Carrello di servizio
Mehrzweckwagen
Chariot de service
Carrito para desocupar

art.	cm.
44822-80	80x50x93,5
44822-99	100x50x93,5

To be assembled, 4 swivel castors, 2 with brakes. Max load per shelf kg 30. – Fornito smontato, 4 ruote girevoli di cui 2 con freno. Portata max. per ripiano kg 30.



PP

Serving trolley

Carrello di servizio
Mehrzweckwagen
Chariot de service
Carrito para desocupar

art.	cm.
44030-03	42x71x90



PP

Bins and containers

Cesti e contenitori
Kasten und Körbe
Réipients et containers
Cubos y contenedores

art.	cm.
44031-04	52x39x12,7
44031-05	52x39x17,7



PE

Container

Contentitore
Kaste
Réipient
Contenedor

art.	cm.
44031-01	33,7x23x56
44031-02	33,7x23x18,7



PP

Serving trolley

Carrello di servizio
Mehrzweckwagen
Chariot de service
Carrito para desocupar

art.	cm.
49995-04	97x51x99

Load max 135 kg (45 kg per shelf).
Carico max 135 kg (45 kg per ripiano).



SS

Minibar restocking cart

Carrello rifornimento frigobar
Wagen für Minibar-Versorgung
Chariot mini-bar
Carro servizio minibar

art.	cm.
44095-30	73x47x102

3 PVC boxes with anti-tip cage for 40 bottles ø 6,5 cm max. Castor wheels ø 12,5 cm, 2 with brakes. – Con 3 cassette in PVC, dotate di gabbia antiribaltamento per 40 bottiglie ø cm 6,5 max. Ruote piroettanti ø cm 12,5 di cui 2 con freno.



Minibar restocking cart

Carrello rifornimento frigobar
Wagen für Minibar-Versorgung
Chariot mini-bar
Carro servizio minibar

art.	cm.
44095-32	100x62x119

Side handle. Key lock. 2 fixed and 2 swivel casters ø 16 cm 2 with brakes. – Maniglia laterale di spinta. Chiusura con chiave. Ruote ø cm 16, di cui due fisse e due piroettanti con freno.



SS

Utility rack GN 2/1

Carrello GN 2/1
2/1 GN-Behälterwagen
Chariot GN 2/1
Carro GN 2/1

art.	cm.
44801-18	73x62x94,5

To be assembled, 9 rails, accomodates GN pans height 65 mm. Load max 150 kg. – Fornito smontato, 9 guide, accoglie GN di h. 65 mm. Carico max 150 kg.



SS

Baking sheet trolley

Carrello porta teglie
Backbleche-Wagen
Chariot pour plaques
Carro porta placas

art. cm.

44826-20 69x49x187

20 rails for baking sheets cm 60x40, height clearance 8 cm. Load max 100 kg. – 20 guide per teglie cm 60x40, distanza guide 8 cm. Carico max 100 kg.



Baking sheet trolley, galvanized steel

Carrello porta teglie, zincato
Backbleche-Wagen, verzinkt
Chariot pour plaques, galvanisé
Carro porta placas, galvanizado

art. cm.

44825-20 51x50x170

20 rails, height clearance 8 cm. Load max. 80 kg. – 20 guide, distanza guide 8 cm. Carico max 80 kg.



Baking sheet trolley, galvanized steel

Carrello porta teglie, zincato
Backbleche-Wagen, verzinkt
Chariot pour plaques, galvanisé
Carro porta placas, galvanizado

art. cm.

44825-40 51x75x170

40 rails, height clearance 8 cm. Load max 160 kg. – 40 guide, distanza guide 8 cm. Carico max 160 kg.



SS

Dolly for cases

Carrello porta cassette
Plattformwagen
Chariot à caisses
Carretilla de transporte

art. cm.

44026-60 65x45x12

Load max 50 kg. – Carico max 50 kg.



PE

Platform cart

Carrello trasporto materiali
Plattformwagen
Chariot de transport
Plataforma móvil

art. cm.

49378-00 82,6x52x98,7

Three position handle ensures optimum handling whatever the load. Non slip deck, 2 swivel and 2 rigid castors. Load 181 kg. – Maniglia regolabile in 3 posizioni. Superficie antiscivolo. 2 ruote fisse, 2 pivotanti. Carico 181 kg.



PP

Trolley, convertible

Carrello convertibile
Plattformwagen, umwandelbar
Chariot convertible
Carretilla convertible

art. cm.

49379-00 56x53x43,5

Four non-marking casters (two rear locking), 2 swivel and 2 rigid. – Ruote antitraccia di cui 2 fisse e 2 girevoli, ruote posteriori bloccabili.



CLEANING & SAFETY PULIZIA & SICUREZZA





PP

Changing table

Fasciatoio da parete
Windeln-Tisch
Table à langer
Mesa cambia-pañales

art.	cm.
49336-00	91x71x49,6
49336-02	60x88x48

Rated for continuous use up to 23 kg. – Portata max in uso 23 kg.



PP

Sturdy chair

Seggiolone
Kinderstuhl
Chaise d'enfant
Silla niños

art.	cm.
49337-00	60x60x75,5
49337-01	29x47x8,3

For children up to 3 years old or 18 kg weight. With Microban antimicrobial protection. – Adatto a bambini fino a 3 anni o 18 kg di peso. Con protezione antibatterica in Microban.



W

Sturdy chair

Seggiolone
Kinderstuhl
Chaise d'enfant
Silla niños

art.	cm.	col.
49335-01	50x50x75	●
49335-02	50x50x75	●

Suitable for children from 6 months to 3 years. Max 20 kg. Solid and sturdy, built with rubber tree wood, respecting the environment. Wide base for greater stability. Easy to assemble. Stackable to save space. Supplied with seat belts and safety buckle. – Adatto ai bambini da 6 mesi a 3 anni. Fino a 20 kg. Solido e robusto, costruito con legno di albero della gomma, in rispetto dell'ambiente. Base larga per una maggiore stabilità. Facile da montare. Impilabile per risparmiare spazio. Fornito con cinture e fibbia di sicurezza.



Trolley Quick Cart

Carrello Quick Cart
Quick Cart-Wagen
Chariot Quick Cart
Carretilla Quick Cart

art.	cm.	Kg.	cap. m3
44178-01	42x36x43	6,5	0,05
44178-02	42x36x53	7,0	0,06

Versatile compartments allow for multiple configurations and uses. Removable caddy. Adjustable dividers. Teflon fabric protector, repels water, oil and stains. Reinforced rubberised kick plate. – Scompatti versatili consentono molteplici configurazioni e usi. Cestello estraibile. Divisori removibili. Rivestimento in Teflon, respinge acqua, olio e macchie. Scocca rinforzata in gomma.



PP

Service trolley

Carrello di servizio
Servicewagen
Chariot de service
Carro de habitaciones

art.	cm.	lt.	Kg.
44174-24	177x58x107	120+120	26,4

Wheels ø 125 mm, 2 bag holders + 2 bags It 120. Made in PP copolymer. – Ruote ø 125 mm, 2 portasacco pieghevoli + 2 sacco It 120. Prodotto in PP copolimero.



PP

Service trolley

Carrello di servizio
Servicewagen
Chariot de service
Carro de habitaciones

art.	cm.	lt.	Kg.
44177-12	104x56x130	150	26

Frame in tubular steel rilsan coated. Wheels ø 125 mm. 3 wooden shelves 50x46 cm. Bag holder + canvas bag polyester 55x55x94 cm. – Montanti in tubolare inox verniciato rilsan. Ruote ø 125 mm. 3 ripiani legno 50x46 cm. Portasacco+sacco in tela poliestere 55x55x94 cm.



PP

Housekeeping cart for linen collection

Carrello portabiancheria
Hotelwäschewagen
Chariot d'étage à linge
Carro de recogida de ropa

art.	cm.	lt.	Kg.
44176-30	105x55x105	300	12,5

Frame in tubulast steel rilsan coated. Wheels ø 125 mm. Nylon bag. – Montanti in tubolare inox verniciato rilsan. Ruote ø 125 mm. Sacco in nylon plastificato.



Housekeeping cart for linen collection

Carrello portabiancheria
Hotelwäschewagen
Chariot d'étage à linge
Carro de recogida de ropa

art.	cm.	lt.	Kg.
44175-15	62x60x103	150	6,39

Capacious canvas bag laminated washable at 30°C. Folding frame. Swivel casters ø 80 mm. – Capiente sacco in tela plastificata lavabile a 30°C. Telaio pieghevole. Ruote piroettanti ø 80 mm.



Cleaning system, Pulse

Sistema di pulizia, kit Pulse
Reinigungssystem Pulse
Système de nettoyage Pulse
Sistema de limpieza Pulse

art.	cm.
44151-00	12,4x9,5x142

Aluminum frame 40 cm and 2 microfibre mops. On-board reservoir 700 ml that allows to clean up to 80 sqm. – Telaio in alluminio con velcro da 40 cm, 2 mop in microfibra. Dotato di deposito integrato da 700 ml che permette di pulire fino a 80 mq.



Microfibre mops

Mop in microfibra
Microfiber-Mops
Franges en microfibra
Fregadoras de microfibra

art.	cm.	des.	U. Pack
44151-AA	40x14	Wet	10
44151-AB	40x14	High absorb	10
44151-AC	40x14	Scrubber	10

Wet use, high absorbency, for 80 sqm. Launderable up to 500 times (200 with bleach) at high water temperature. – Uso umido ad elevata assorbenza 80 mq. Ciclo di vita: 500 lavaggi (200 con candeggina) ad elevate temperature.



Dust beater V sweeper

Scopa a forbice
Doppel-Wischmop
Balai double mop
Escoba doble

art.	h. cm.
44160-03	135

Opening angle 140° about. Cotton mops length 100 cm. – Apertura 140° circa. Frange in cotone 100 cm.



Mechanical sweeper

Aspirapolvere meccanico
Kehrer mit mechanischem Antrieb
Balai mécanique
Escoba mecánica

art.	cm.	lt.
44150-19	28,5x25x102	0,6

ABS and galvanised steel construction. Ideal for hard floors and low pile carpets. Sweeping path 19 cm. – ABS e acciaio galvanizzato. Ideale sia per tappeti/moquette a pelo corto che per pavimenti. Battuta 19 cm.



PP

Broom + dust pan

Scopa + alza immondizia
Kehrset mit Stiel und Schmutzcontainer
Balai + pelle
Escoba + recogedor

art.	cm.
44149-03	28,6x13x32,5

Self opening and closing lid. Broom hanger bracket. – Porta immondizia con coperchio. Staffa di supporto per scopa.



PP

Dustpan

Pattumiera
Müllschaufel
Pelle à poussière
Pala

art.	cm.
44170-00	29x28x87,5

Shock-proof plastic material, equipped with a rubber blade that adheres perfectly to the floor. Aluminium handle. – Materiale plastico antiurto, dotata di una lamina di rifinitura in gomma che aderisce perfettamente al pavimento.





PP

Broom, aluminum rod

Scopa, manico alluminio
Besen mit Alustiel
Balai, manche alu
Escoba, mango alumimio

art.	h. cm.
44170-01	80

To use in combination with the handy dustpan thanks to its ergonomic grip with handle holder.
Da utilizzarsi abbinata alla pattumiera, a cui può essere agganciata tramite l'attacco portamanico.



Wet mop handles

Manico per mop
Nassmopp-Stiele
Supports pour franges
Mangos para fregonas

art.	cm.	col.
44141-01	152,4	●
44141-03	152,4	●

Polypropylene/Glass fiber.
Polipropilene/fibra di vetro.



Cotton-end string mop

Mop a strisce in cotone
Spaghetti-Mop mit Baumwollend
Frange à ficelles en coton
Mopa de algodón

art.	gr.
44142-40	400



Cotton mop rod, screw fitting

Manico per mop, attacco filettato
Mop-Stange mit Schraubanschluss
Manche pour mop avec attache à vis
Mango para fregadora, conexión tornillo

art.	Ø cm.	cm.
44167-13	2,2	130

Red lacquered iron. Lightweight and rustproof.
Ferro verniciato rosso. Leggero ed inossidabile.



Cotton mop, screw fitting

Mop in cotone, attacco filettato
Baumwollmop mit Schraubanschluss
Mop en coton avec attache à vis
Mopa de algodón

art.	gr.
44166-28	280



Telescopic rod

Manico telescopico
Teleskopstange
Manche telescopique
Mango telescópico

art.	Ø cm.	cm.
44161-00	2,3	97>184

Two-piece anodized aluminum rod.
Alluminio anodizzato due pezzi.



Mop holder

Pinza per mop
Wischmophalter
Pince faubert
Pinza

art.
44164-00

Universal ring allows the use of any handle with from ø 20 to 24 mm. – Ghiera universale consente l'utilizzo di qualsiasi manico con ø 20>24 mm.



Cotton-end string mop

Mop a strisce in cotone
Spaghetti-Mop mit Baumwollend
Frange à ficelles en coton
Mopa de algodón

art.	gr.
44165-35	350
44165-40	400
44165-50	500



Microfibre cloth, 24 pcs

Panno in microfibra, 24 pz
Mikrofasertuch, 24 Stk
Carré en microfibre, 24 pcs
Paño de microfibra, 24 pz

art.	cm.	col.
44147-30	30x30	●
44147-31	30x30	●
44147-32	30x30	●
44147-33	30x30	●

Removes 99.9% of microbes. Launderable up to 100 times with bleach and 200 without bleach.
Rimuove il 99,9% dei microbi. Resiste fino a 200 lavaggi e 100 candeggi.





PP

Floor sign, 2-sided

Cavalletto segnalazione a 2 lati
Warnschild, 2-seitig
Panneau d'avertissement 2 côtés
Señal de suelo 2 lados

art.	h. cm.
44077-00	57
44077-CC	67



Telescopic door sign

Segnalatore telescopico di sicurezza
Teleskop-Sicherheitstürschild
Panneau de sécurité télescopique
Señal de seguridad telescópico

art.	cm.
44077-10	63,5x2,5x33

Aluminium/Vinyl. Width open 112 cm. Extendable pole to block out doorways and entrances.
Alluminio/Vinile. Larghezza aperto 112 cm. Palo estensibile per bloccare porte e ingressi.



PP

Multi-purpose trolley

Carrello multiuso
Allzweckwagen
Chariot multi-usage
Carro de limpieza

art.	cm.
44173-00	97x68x111

Bag holder with cover, bag lt. 120, pan with hooks, 2 buckets 4 lt. and 2 buckets 15 lt., wringer. – Portasacco con cop., sacco lt. 120, vaschetta con ganci, 2 secchi 4 lt., 2 secchi 15 lt. 15, strizzatore.



PP

Mopping trolley with press

Carrello lavapavimenti con strizzatore
Wringer Reinigungswagen mit Presse
Chariot de ménage avec presse
Carro con prensa escurridora

art.	cm.
44171-24	62x42x90

Wringer and 25 lt. bucket. With storage compartment. PSV reinforced handle.
Strizzatore e 1 secchio lt. 25. Vano portaoggetti. Impugnatura in PSV completa di rinforzi.



PP

Mopping trolley with press

Carrello lavapavimenti con strizzatore
Wringer Reinigungswagen mit Presse
Chariot de ménage avec presse
Carro con prensa escurridora

art.	cm.
44171-50	69x42x90

Wringer and 2 buckets lt. 25 each. Painted handle, reversible. – Strizzatore e 2 secchi da lt. 25. Impugnatura verniciata, reversibile.



PP

Mopping trolley with press

Carrello lavapavimenti con strizzatore
Wringer Reinigungswagen mit Presse
Chariot de ménage avec presse
Carro con prensa escurridora

art.	cm.
44172-30	47x40x93

Single tank with wringer.
Monovasca con strizzatore.



PP

Graduated bucket

Secchio graduato
Eimer mit Skala
Seau gradué
Cubo con medidas

art.	cm.	lt.	col.
44169B06	24x19x21,5	6	●
44169R06	24x19x21,5	6	●



PP

Graduated bucket

Secchio graduato
Eimer mit Skala
Seau gradué
Cubo con medidas

art.	cm.	lt.	col.
44169B14	34x33,5x28	15	●
44169R25	37x36,5x32	25	●



PP

Bucket with wringer

Secchio con strizzatore
Eimer mit Presse
Seau avec essoreur
Cubo con prensa

art.	cm.	lt.
44168-12	35x27x29,5	12

With graduated scale 0-12 lt.
Scala graduata 0-12 lt.



PP

Waste container

Cestino
Abfallbehälter
Collecteur
Papelera

art.	Ø cm.	h. cm.	lt.
44097-00	30	31,5	15,9



PP

Waste container SLIM JIM

Contentore rifiuti
Abfallbehälter
Collecteur
Colector

art.	cm.	lt.
49931-60	59x28X63	60
49931-87	56x28X76	87



PP

Hinged lid

Coperchio ancorato
Klapp-Deckel
Couvercle à charnière
Tapa abatible

art.	cm.
49931-00	55,6x34x3



PP

Lid

Coperchio
Deckel
Couvercle
Tapa

art.	cm.	col.
49931A00	52x29x7	●
49931C04	52x29x7	●
49931B05	52x29x7	●



PP

Dolly SLIM JIM

Carrello
Transportwagen
Chariot
Carrito

art.	cm.
49931-64	60,6x37,4X21

Side clip allows to tow together more trolleys/dal release fast and simple. – Aggancio laterale a clip che permette di trainare insieme diversi carrelli. Rilascio a pedale semplice e veloce.



NEW

PP

Waste bin

Bidoncino
Abfallbehälter
Poubelle
Colector

art.	cm.	lt.	col.
44084-01	37x37x41	25	●
44084-02	37x37x41	25	●
44084-03	37x37x41	25	●
44084-04	37x37x41	25	●

Stackable and nestable. Easy emptying system thanks to ergonomic grips on the bottom, reinforced hinges to allow a 270° opening. Provided with a hinged and anti stray lid, ergonomic handle with vertical locking. Made from polypropylene compound, 100% recyclable, weather, chemical and UV resistant allowing it to be safely used outside.



NEW

PP

Waste bin

Bidoncino
Abfallbehälter
Poubelle
Colector

art.	cm.	lt.	col.
44085-01	37x37x52	35	●
44085-02	37x37x52	35	●
44085-03	37x37x52	35	●
44085-04	37x37x52	35	●

Impilabile e inseribile. Presa sul fondo per un facile svuotamento, coperchio con cerniere rinforzate per una apertura a 270°. Dotato di sportello basculante a becco e coperchio con meccanismo antirandagismo e maniglione con blocco verticale. Realizzato in compound di Polipropilene (PP) riciclabile al 100%, resistente agli agenti atmosferici, chimici ai raggi UV per utilizzo intensivo all'esterno.



PE
PC

Step on bin
Pattumiera a pedale
Pedaleimer
Poubelle à pédale
Colector a pedal

art.	cm.	lt.
49933-50	53x34x72	50



NEW
PE

Step on bin
Pattumiera a pedale
Pedaleimer
Poubelle à pédale
Colector a pedal

art.	cm.	lt.
49929R30	41,3x40x43,5	30
49929R45	41,3x40x60	45
49929R68	50,2x41x67,3	68
49929R87	50,2x41x82,6	87



NEW
PE

Step on bin
Pattumiera a pedale
Pedaleimer
Poubelle à pédale
Colector a pedal

art.	cm.	lt.
49929W30	41,3x40x43,5	30
49929W45	41,3x40x60	45
49929W87	50,2x41x82,6	87



PE

Mobile pedal bin
Pattumiera a pedale
Pedaleimer
Poubelle à pédale
Colector a pedal

art.	cm.	lt.
44095-12	48x55x93	120

Certified UNI EN 840. Withstanding chemical, can be washed and sterilized. – Certificata UNI EN 840. Resistente agli agenti chimici, lavabile e sterilizzabile.



PP

Mobile pedal bin
Pattumiera a pedale
Pedaleimer
Poubelle à pédale
Colector a pedal

art.	cm.	lt.
44095-18	40x65x81	80



PP

Mobile pedal bin
Pattumiera a pedale
Pedaleimer
Poubelle à pédale
Colector a pedal

art.	cm.	lt.	col.
44096-80	48x50x78	80	○
44096B80	48x50x78	80	●
44096Y80	48x50x78	80	●
44096R80	48x50x78	80	●
44096G80	48x50x78	80	●



Refuse bag holder trolley
Carrello portasacco
Sackhalterwagen
Chariot porte-sac
Colector móvil

art.	cm.	lt.
44089-12	58x56x102	120

Coated iron foldable frame. Round bag holder, pivouetting wheels Ø 80 mm. – Telaio pieghevole in acciaio verniciato. Portasacco rotondo. Ruote piroettanti Ø 80 mm.



PP

Mobile pedal bin
Pattumiera a pedale
Pedaleimer
Poubelle à pédale
Colector a pedal

art.	cm.	lt.	col.
49899-01	46x32x80	70	●

Mechanical parts in stainless steel. The lid can be removed. – Parti meccaniche in acciaio inox. Coperchio staccabile.



PP

Pedal bin lids
Coperchi pattumiera
Pedaleimer-Deckel
Couvercles poubelle
Tapas para colector

art.	cm.	col.
49899-91	46x32	●
49899-92	46x32	●
49899-93	46x32	●
49899-94	46x32	●
49899-95	46x32	●





PE

Tilt truck

Benna ribaltabile
Falten Eimerwagen
Benne
Carrito plegable

art.	cm.	lt.	Kg.
49934-04	145x68x86	400	205
49934-06	164x77x97	600	272
49934-08	180x85x107	800	570



PE

Domed linged lid

Coperchio a doppia apertura
Doppel-Deckel
Couverture double
Tapa doble

art.	cm.
49934-14	132x71x23
49934-16	155x81x23
49934-18	169x87x23

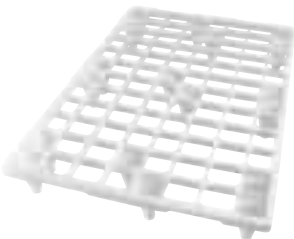

PE

Pallet

Pallet
Pallet
Palette
Racks para suelos

art.	cm.	Kg.
49373-05	80x120x14	4,6

Static load 1000 kg. Appropriate for food.
Carico statico 1000 kg. Per uso alimentare.



Dunnage rack

Pedana
Lageruntersätze
Palettes
Bancada

art.	cm.	load kg
49371-09	91,4x56x30,5	68
49371-12	122x56x30,5	136

Rust and corrosion-proof polymer material.
Materiale polimerico resistente alla ruggine e alla corrosione.



PP

Standing ashtray

Posacenere/fioriera
Standascher
Cendrier sur pied
Cenicero

art.	Ø cm.	h. cm.
49892-40	40	60

Included bag of sand 1,5 kg.
Incl. sacchetto sabbia kg 1,5.

RETRACTABLE BARRIERS ASTE DELIMITA CORSIE

Tubular structure in stainless steel matte finish or black lacquered ø 63 mm, thickness 0,8 mm. 4-way retractable polyester black belt length 2,13 meters, width 4,8 cm. Ballasted base ø cm 31 with rubber under the base. Weight 10 kg. Overall height 1 mt. Possibility to apply landscape display.

Struttura tubolare in acciaio inossidabile finitura satinata o laccata nera ø 63 mm, spessore 0,8 mm. Nastro retrattile 4-vie in poliestere nero lunghezza 2,13 metri, larghezza 4,8 cm. Base zavorrata ø 31 cm con gomma sotto la base. Peso 10 kg. Altezza totale 1 mt. Possibilità di applicare tabella segnaletica.



Retractable barrier set

Set aste delimita corsie a nastro estensibile

Absperrpfost mit einziehbarer Gurt, 2 Stk

Set poteaux avec ceinture rétractable

Juego de columnas móviles con cinta retráctil

art.	Ø cm.	base Ø cm.	belt/nastro	h. cm.	Kg.
44183-01	6,3	36	cm 213x4,8	100	10

Black laquered. – Laccato nero.

Retractable barrier set

Set aste delimita corsie a nastro estensibile

Absperrpfost mit einziehbarer Gurt, 2 Stk

Set poteaux avec ceinture rétractable

Juego de columnas móviles con cinta retráctil

art.	Ø cm.	base Ø cm.	belt/nastro	h. cm.	Kg.
44184-01	6,3	36	cm 213x4,8	100	10

Stainless steel matt finish. – Inox finitura satinata.



Post top sign holder

Tabella

Posterhalter

Porte-enseigne

Cartelera

art.	cm.
44183-A4	DIN-A4
44183-A3	DIN-A3

Black laquered. – Laccato nero.

Post top sign holder

Tabella

Posterhalter

Porte-enseigne

Cartelera

art.	cm.
44184-A4	DIN-A4
44184-A3	DIN-A3

Stainless steel matt finish. – Inox finitura satinata.



ELECTRIC APPLIANCES APPARECCHI ELETTRICI



**Dualit.****4 slot toaster**

Tostapane 4 fette
 Brotröster
 Grille pain
 Tostadora

art.	cm.	Kg.	kW
49801-04	36x21x22	4,25	2,2

**Dualit.****6 slot toaster**

Tostapane 6 fette
 Brotröster
 Grille pain
 Tostadora

art.	cm.	Kg.	kW
49801-06	46x21x22	5,1	3

**Dualit.****4 slice bun toaster**

Tostapane 4 fette
 Brotröster
 Grille pain
 Tostadora

art.	cm.	Kg.	kW
49802-04	36x21x22	4,52	1

**Dualit.****6 slice bun toaster**

Tostapane 6 fette
 Brotröster
 Grille pain
 Tostadora

art.	cm.	Kg.	kW
49802-06	46x21x22	5,52	1,5

**Dualit.****Conveyor Toaster**

Tostapane a nastro
 Durchlauf-Toaster
 Toaster convoyeur
 Tostador a túnel

art.	cm.	Kg.	kW
49803-02	44x43x41,3	14	2,7

**Conveyor toaster, CT540 B**

Tostapane a nastro doppia uscita
 Durchlauf toaster
 Toaster convoyeur
 Tostador a túnel

art.	cm.	Kg.	kW
49850-20	50x68x34,5	20	2,65





Toaster, BAR 1000
Tostapane
Toast-/Überbackgerät
Toaster
Tostador de pan

art.	cm.	Kg.	kW
49850-65	45x28,5x30,5	10	2



Contact grill, SAVOYE
Grill a contatto
Kontaktgrill
Grill à contact
Grill de contacto

art.	cm.	Kg.	kW
49850-22	33x38,5x22	18	2



Contact grill, PANINI
Grill a contatto
Kontaktgrill
Grill à contact
Grill de contacto

art.	cm.	Kg.	kW
49850-21	43x38,5x22	22,5	3



Contact grill double plate, MAJESTIC
Grill a contatto doppia piastra
Kontaktgrill, 2 Platten
Grill à contact, 2 plaques
Grill de contacto doble

art.	cm.	Kg.	kW
49850-23	60x38,5x22	33,5	2x2



Contact sandwich toaster
Grill a contatto
Sandwich-Toaster
Appareil croque monsieur
Grill de contacto

art.	cm.	Kg.	kW
49806-00	40x22x19	6	1,6

Dualit.



Contact grill, PANINI XL
Grill a contatto
Kontaktgrill
Grill à contact
Grill de contacto

art.	cm.	Kg.	kW
49850-19	41x62x34	32	3,6



**Glas ceramic contact grill, GVS 335**

Grill a contatto vetroceramica
 Kontaktgrill, Glaskeramik-Platte
 Grill à contact vitrocéramique
 Grill de contacto vitrocerámica

art.	cm.	Kg.	kW
49850-18	39x60x26	14	3

**Salamander, SEM 600 PDS**

Salamandra
 Salamandrs mit PDS
 Salamandre avec détection de plat
 Salamandra con PDS

art.	cm.	Kg.	kW
49850-71	60x64x59	56	3

**Hot dog heater, CS 3 E**

Scalda würstel
 Würstchenwärmer
 Chauffe-saucisses
 Calentador de salchichas

art.	cm.	Kg.	kW
49850-61	44x30x40	9	0,65

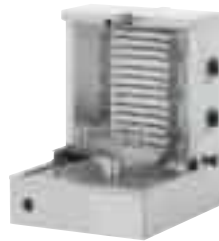
**Kebab/Gyros grill, GR 40 E**

Griglia kebab/gyros
 Elektro-Dönergrill
 Gril à kebab/gyros
 Asador de kebab/gyros

art.	cm.	Kg.	kW
49850-13	58x66x69,5	15	3,6

**Kebab/Gyros grill, GR 60 E**

Griglia kebab/gyros
 Elektro-Dönergrill
 Gril à kebab/gyros
 Asador de kebab/gyros

art.	cm.	Kg.	kW
49850-14	58x66x87	25	5,8

**Crepe machine, high-capacity, CFE 400**

Crepiera tonda, ad alto rendimento
 Crêpegerät
 Crêpière à haut rendement
 Crepera

art.	Ø cm.	h. cm.	Kg.	kW
49850-33	40	20	18	3,6





Crepe machine, CSE 400

Creperia
Crêpegerät
Crêpière
Crepera

art.	Ø cm.	cm.	Kg.	kW
49850-11	40	45x50x24	23	3,6



Eggs boiler, CO 60

Bollitore uova
Eierkocher
Cuiseur à oeuf

Caldera para huevos

art.	cm.	Kg.	kW
49850-36	21,5x43x25,5	4,5	1,2



Multifunction oven, FC 280

Forno multifunzione
Multifunktionsofen
Four multifonctions
Horno multifunción

art.	cm.	Kg.	kW
49850-73	46x55x35,5	20	1,5



Multifunction oven, FC 380 TQ

Forno multifunzione
Multifunktionsofen
Four multifonctions
Horno multifunción

art.	cm.	Kg.	kW
49850-75	55x55x35,5	22	2,4



Multifunction oven, FC 60 TQ

Forno multifunzione
Multifunktionsofen
Four multifonctions
Horno multifunción

art.	cm.	Kg.	kW
49850-76	59,5x61x59	38	3

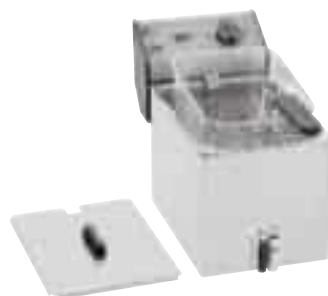

Fryer, FD 80 R

Friggitrice
Friteuse
Friteuse
Freidora

art.	cm.	kg./H	Kg.	kW
49850-41	26,5x45x36	15	8	3,6



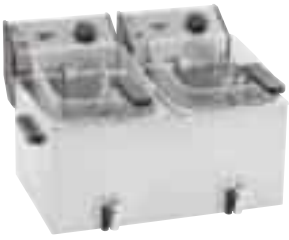

Fryer, FD 80 DR

Friggitrice
Fritteuse
Friteuse
Freidora

art.	cm.	kg./H	Kg.	kW
49850-42	59x45x37	30	15	2x3,6



Fryer, FD 50

Friggitrice
Fritteuse
Friteuse
Freidora

art.	cm.	kg./H	Kg.	kW
49850-37	21,5x42,5x32	10	5	3,2



Dish-warmer, DW106 / 110

Scaldapiatti
Rechaud
Chauffe plats
Calentador de platos

art.	cm.	Kg.	kW
49850-06	40x21,5x33,5	14	0,65
49850-10	40x21,5x47,5	25	1,3



Ventilated warming display, WD 780 DI

Espositore caldo ventilato
Konvektion-Warme Theke
Présentoir chaud à convection
Expositor caliente con convección

art.	cm.	Kg.	kW
49850-70	78x49x64	35	1,8



Warming display

Vetrina riscaldata
Warmhalte-Vitrine
Vitrine chauffante
Vitrina caliente

art.	GN	cm.	Kg.	kW	range
49850-43	1/1	59x35x28,5	12	0,65	+20 +95°C



Warming display

Vetrina riscaldata
Warmhalte-Vitrine
Vitrine chauffante
Vitrina caliente

art.	GN	cm.	Kg.	kW	range
49850-44	2x 1/1	59x35x39	15	0,65	+20 +95°C



Tapas display

Vetrina antipasti
Vorspeisen-Schaufenster
Vitrine tapas
Vitrina para tapas

art.	cm.	Kg.	W	range
49630-06	145x40x26	33	160	+2/+5°C



Ice cream maker

Macchina per gelato
Eismaschine
Machine à glace
Maquinas helado

art.	cm.	lt.	kg./H	Kg.	kW
49949-19	51x31x35	1,5	3	30	0,4





Dehydrator for fruits and vegetables

Disidratatore per frutta e verdura

Dehydratisierapparat

Déshydrateur fruits et légumes

Deshidratador de frutas y verduras

art.	cm.	Kg.	kW	range
49953-02	43,5x29x21	3,6	0,53	+30 +80°C

Supplied with 6 reversible trays. Timer up to 72 hours.

6 vassoi reversibili. Timer fino a 72 ore.



Smoker, 2 levels

Affumicatoio a 2 piani

Räucherofen

Fumoir

Ahumador

art.	cm.	Kg.	kW
49850-63	45x45x35	25	1,5



Table-top cutter

Cutter da tavolo

Gemüseschneidmaschine

Cutter à légumes

Cortador verduras

art.	cm.	lt.	Kg.	V
49979-03	32x52x62	3	12	115-220-240

Single phase. Anodised aluminium, s/s container and blades, transparent lid.

Monofase. Alluminio anodizzato, contenitore e lame inox, coperchio trasparente.



Electric peeler

Pelatrice elettrica

Elektr. Schälmachine

Eplucheur électrique

Pelador eléctrico

art.	cm.	Kg.
49750-00	25x16x21,5	2



Dualit.

Waffle iron

Macchina per cialde

Waffeleisen

Gufrier

Gofrera

art.	cm.	Kg.	kW
49809-00	40x22x19	5,5	1,6



**Single waffle iron, GESIMPLE**

Macchina per cialde
Waffeleisen mit 1 Platte
Gaufrier simple
Gofrera singular

art.	cm.	Kg.	kW
49850-24	30,5x44x23	22	1,6

Squares 20x25 mm.

**Single waffle iron, GESIMPLE**

Macchina per cialde
Waffeleisen mit 1 Platte
Gaufrier simple
Gofrera singular

art.	cm.	Kg.	kW
49850-25	30,5x44x23	22	1,6

Squares 15x18 mm.

**Single waffle iron, GESIMPLE**

Macchina per cialde
Waffeleisen mit 1 Platte
Gaufrier simple
Gofrera singular

art.	cm.	Kg.	kW
49850-26	30,5x44x23	22	1,6

**Single waffle iron, GESIMPLE**

Macchina per cialde
Waffeleisen mit 1 Platte
Gaufrier simple
Gofrera singular

art.	cm.	Kg.	kW
49850-27	30,5x44x23	22	1,6

**Single waffle iron, GES23**

Macchina per cialde
Waffeleisen mit 1 Platte
Gaufrier simple
Gofrera singular

art.	cm.	Kg.	kW
49850-03	30,5x44x23	22	1,6

**Infrared lamp with warming plate**

Lampada ad infrarossi con piano caldo
Infrarot Wärmebrücke mit Wärmeplatte
Lampe infrarouge avec plaque chauffante
Lámpara infrarrojos y placa caliente

art.	GN	cm.	kW
49993-21	1/1	38x53x70	0,5
49993-22	2/1	70x53x71	1,0
49993-23	3/1	103x53x70	1,5

Curved plexiglass fender. Separate switches for plate and lamps. Adjustable thermostat +30°C +90°C. – Parafiato in plexiglass curvo. Interruttori di accensione separati per piano caldo e lampade. Termostato regolabile +30°C +90°C.

**Infrared lamp**

Lampada ad infrarossi
Infrarot Wärmebrücke
Lampe infrarouge
Lámpara infrarrojos

art.	GN	cm.	kW
49993-01	1/1	38x53x70	0,25
49993-02	2/1	70x53x71	0,50
49993-03	3/1	103x53x70	0,75

Curved plexiglass fender. – Parafiato in plexiglass curvo.

SS

SS





SS

Warming plate

Piano caldo
Wärmeplatte
Plaque chauffante
Placa caliente

art.	GN	cm.	kW
49993-11	1/1	33x53x6	0,25
49993-12	2/1	66x53x6	0,50
49993-13	3/1	132x53x6	0,75

Adjustable thermostat +30°C +90°C. – Termostato regolabile +30°C +90°C.



SS

Table with hot box

Tavolino con box termico
Tisch mit Hot Box
Table avec hot box
Carrito con hot box

art.	Ø cm.	h. cm.	W
44094-04	90/54,6	78,6	500

Table with fold down flaps. With capsizable top for stacking when not in use.
Tavolo con flaps pieghevoli. Ribaltabile e impilabile quando non in uso.



Mixer/liquidiser combi unit

Combi mixer/frusta
Kombigerät
Combiné mixeur-fouet
Brazo triturador/batidor, unidad combinada

art.	h. cm.	Kg.	kW	rpm
49907-01	79	4,95	0,35	15000

For containers up to 100 liters. – Per contenitori fino a 100 litri.



Liquidiser

Mixer
Stabmixer
Mixeur
Brazo triturador

art.	h. cm.	Kg.	kW	rpm
49907-06	55,5	1,45	0,25	15000

For containers up to 30 liters. – Per contenitori fino a 30 litri.



Wall rack

Supporto murale
Wandständer
Support mural
Soporte mural

art.
49907-AA



Liquidiser

Mixer
Stabmixer
Mixeur
Brazo triturador

art.	h. cm.	Kg.	kW	rpm
49911-24	24	1,4	0,27	2000:12500
49916-25	25	3,0	0,27	2300:9600
49916-35	35	3,3	0,35	2300:9600
49916-45	45	4,9	0,44	1500:9000
49916-55	55	5,2	0,75	9000



**Mixer/liquidiser combi unit**

Combi mixer/frusta

Kombigerät

Combiné mixeur-fouet

Brazo triturador/batidor, unidad combinada

art.	h. cm.	Kg.	kW	rpm
49911-19	19	1,9	0,25	2000-12500
49911-30	30	3,1	0,30	2300-9600
49911-35	35	5,9	0,44	1500-9000
49911-45	45	6,1	0,50	1500-9000

**Table-top cutter R4**

Cutter da tavolo

Gemüeschneidmaschine

Cutter à légumes

Cortador verduras

art.	cm.	lt.	Kg.	kW	rpm
49943-01	21x32x43	4,5	17	0,9	1500/3000

**Table-top cutter R5 - 2V**

Cutter da tavolo

Gemüeschneidmaschine

Cutter à légumes

Cortador verduras

art.	cm.	lt.	Kg.	kW	rpm
49943-02	28x36,5x51	5,9	21	1,5	1500/3000

**Emulsifier-mixer Blixer 4**

Omogeneizzatore

Mixergerät

Emulsionneur-mixer

Omogenizador/emulsificador

art.	cm.	lt.	Kg.	kW	rpm
49944-01	46x22,5x30,5	4,5	18	1	1500/3000

**Emulsifier-mixer Blixer 4 VV**

Omogeneizzatore

Mixergerät

Emulsionneur-mixer

Omogenizador/emulsificador

art.	cm.	lt.	Kg.	kW	rpm
49944-02	46x22,5x30,5	4,5	18	1,1	300-3500

**Juice extractor J80 Ultra**

Centrifuga

Fruchtpresse

Centrifugeur-presse agrumes

Centrifugadora/exprimidor jugos

art.	cm.	kg./H	Kg.	kW	rpm
49949-20	23,5x42x50,5	60	11	0,7	3000





Vegetable preparation machine CL 50 Ultra

Tagliaverdure
Gemüeschneidmaschine
Coupe-légumes
Cortador verduras

art.	cm.	Kg.	kW	rpm
49940-01	30x36x55,5	15	0,55	375

Suitable also for cutting mozzarella. For cutting discs contact our customer service. – Ideale anche per tagliare mozzarella. Per i dischi di taglio contatta il ns customer service.



Cutter & vegetable slicer R301 Ultra

Combinato cutter/tagliaverdure
Gemüeschneid/- u. Schälmaschine
Cutter/Coupe-légumes
Cortador verduras

art.	cm.	lt.	Kg.	kW	rpm
49942-01	28,5x36x40	3,7	14	0,65	1500

For cutting discs contact our customer service.
Per i dischi di taglio contatta il ns customer service.



Cutter & vegetable slicer R502 VV

Combinato cutter/tagliaverdure
Gemüeschneid/- u. Schälmaschine
Cutter/Coupe-légumes
Cortador verduras

art.	cm.	lt.	Kg.	kW	rpm
49942-03	38x36,5x67	5,9	30	1,3	300-3500

For cutting discs contact our customer service.
Per i dischi di taglio contatta il ns customer service.



Sieving juicer C80

Centrifuga
Passiermaschine
Centrifugeuse
Centrifugadora

art.	cm.	kg./H	Kg.	kW	rpm
49946-01	61x36x54	50	21	0,65	1500



Citrus fruit squeezer

Spremiagrumi
Zitruspresse
Presse agrumes
Exprimidor cítricos

art.	cm.	Kg.	kW	rpm
49922-01	20x30x35	5	0,13	1500



Citrus fruit squeezer

Spremiagrumi
Zitruspresse
Presse agrumes
Exprimidor cítricos

art.	cm.	Kg.	kW	rpm
49922-02	20,5x30,5x49	10	0,23	1500-1800



**Citrus fruit squeezer**

Spremiagrumi
Zitruspresse
Presse agrumes
Exprimidor cítricos

art.	cm.	Kg.	kW	rpm
49922-03	20x30x38	10	0,23	1500-1800

**Citrus fruit squeezer**

Spremiagrumi
Zitruspresse
Presse agrumes
Exprimidor cítricos

art.	cm.	Kg.	kW	rpm
49922-04	24x40x49	10	0,275	1500-1800

**Juice extractor**

Centrifuga, spremisucchi
Fruchtpresse
Centrifugeur-presse agrumes
Centrifugadora/exprimidor jugos

art.	cm.	Kg.	kW	rpm
49922-06	26x47x45	16	0,8	3000-3300

**Ice crusher**

Spaccaghiaccio
Eiszerstosser
Broyeur à glace
Triturador de hielo

art.	cm.	Kg.	kW	rpm
49922-08	24x35x47	10	0,13	73-89

**Drink Mixer**

Frullino frappè
Getränkemixer
Shaker électrique
Batidora para batidos

art.	cm.	Kg.	kW	rpm
49949-09	18,6x18x53	6	0,12	8000-16000

Equipped with 3 stirrers and 2 bowls, s/s and polycarbonate.
Fornito di 3 utensili agitatori e 2 bicchieri, inox e policarbonato.

**Blender**

Frullatore
Getränkemixer
Mixeur
Licuadora

art.	cm.	lt.	Kg.	kW	rpm
49922-22	30x22x56,6	2	11	1,2	500-15000
49922-23	30x22x56,6	4	11	1,2	500-15000

Stainless steel bowl. – Bicchieri inox.





Blender
Frullatore
Getränkemixer
Mixeur
Licuadora

art.	cm.	lt.	Kg.	kW	rpm
49922-20	30x22x56,6	2	11	1,2	500-15000
49922-21	30x22x56,6	4	11	1,2	500-15000

Clear bowl BPA Free. – Bicchiere trasparente BPA Free.



Blender
Frullatore
Getränkemixer
Mixeur
Licuadora

art.	cm.	Kg.	kW
49922-09	20x47x44	9	3

Clear bowl BPA Free. – Bicchiere trasparente BPA Free.



Citrus fruit squeezer
Spremiagrumi
Zitruspresse mit Spritzschutz
Presse agrumes
Exprimidora

art.	cm.	Kg.	kW	rpm
49958-00	31x22x34	8	0,3	1400



Lever citrus fruit squeezer
Spremiagrumi a leva
Zitruspresse mit Pressarm
Presse agrumes à levier
Exprimidora

art.	cm.	Kg.	kW	rpm
49959-00	31x22x35	9	0,34	1400



Blender
Frullatore
Getränkemixer
Mixeur
Licuadora

art.	cm.	lt.	Kg.	kW	rpm
49956-01	20x20x46	1,7	4	0,4	10000-15000

Plastic bowl. – Bicchiere plastica.



Blender
Frullatore
Getränkemixer
Mixeur
Licuadora

art.	cm.	lt.	Kg.	kW	rpm
49957-00	23x23x52	3	5,5	1	12000-22000

Stainless steel bowl. – Bicchiere inox.





Ice crusher
Tritaghiaccio
Eiszerstosser
Broyeur à glace
Trituradora de hielo

art.	cm.	Kg.	kW	rpm
49960-00	42x21x29	11	0,34	1400



Drink mixer
Frullino
Getränkemixer
Shaker électrique
Licuadora

art.	cm.	lt.	Kg.	kW	rpm
49955-01	20x22x50	0,8	2,8	0,12	15000

Plastic bowl. – Bicchiera plastica.



Rice steamer
Cuoci riso a vapore
Reiskocher
Cuit riz
Olla arrocera

art.	Ø cm.	h. cm.	lt.	kW
49954-21	5,0	35	21	3



Water boiler with tap
Bollitore per acqua con rubinetto
Wasserkocher mit Hahn
Chauffe-eau avec robinet
Calentador de agua con grifo

art.	Ø cm.	h. cm.	lt.	Kg.	V	kW
49954-20	37	48	20	5,7	230	2,1

+30°C +100°C



Planetary mixer
Impastatrice planetaria
Knet- u. Schlagmaschine
Batteur-mélangeur
Batodira planetaria

art.	cm.	lt.	Kg.	kW	rpm
49947-08	30x40x58	7,6	27	0,18	1420

3 speeds. Timer 0-15 min. – 3 velocità. Timer 0-15 min.



Planetary mixer
Impastatrice planetaria
Knet- u. Schlagmaschine
Batteur-mélangeur
Batodira planetaria

art.	cm.	lt.	Kg.	kW	rpm
49945-05	38x31x45,5	5	15	0,75	40x260

10 speeds. – 10 velocità.

SS





SS

Microwave oven - PROG

Forno microonde
Mikrowelle
Four à micro-ondes
Microonda

art.	cm.	lt.	Kg.	W
49997-12	51x43x31	26	14,7	1000

Time key X2. 3 cooking stages, 5 power levels. 10 programmable keys. 100 programs. GN 1/2 fixed glass ceramic bottom. – Tasto tempo X2. 3 stadi cottura. 5 livelli di potenza. 10 tasti programmabili. 100 programmi. Fondo fisso in vetroceramica GN 1/2.



SS

Microwave oven - SELF

Forno microonde
Mikrowelle
Four à micro-ondes
Microonda

art.	cm.	lt.	Kg.	W
49997-13	51x43x31	26	14,7	1550

To heat and regenerate food. Customizable time and temperature settings. Per scaldare e rigenerare gli alimenti. Impostazioni tempo e temperatura personalizzabili.



Soft cooker

Apparecchio per cottura sottovuoto
Sous-Vide-Garer
Thermoplongeur
Máquina para cocinar al vacío

art.	cm.	Kg.	kW
49851-10	16,4x22x41,5	8	0,2

Stainless steel structure. Suitable for containers up to 60 liters. Min. height of the tank 180 mm, electronic temperature control with 1/10°C precision, adjustable temperature 0>95°C. Pump for water circulation. Acoustic timer. Possibility to memorize up to 20 programs. Level sensor for lack of water. Struttura in acciaio inox. Per recipienti fino a 60 litri. Altezza minima del recipiente 180 mm, controllo elettronico della temperatura con precisione al 1/10°C, temperatura regolabile 0>95°C. Pompa per la circolazione dell'acqua. Timer acustico. Possibilità di memorizzare fino a 20 programmi. Sensore di livello per mancanza acqua.



Induction cooker TC 3500

Piastra ad induzione
Induktionsplatte
Plaque à induction
Placa de inducción

art.	cm.	Kg.	kW
49998-35	35,5x46x11	5,5	3,5

Stainless steel body, Schott Ceran surface. Thermocontrol. 12 power levels. Temperature preselection 60-240°C. Timer 23 hours 59 min. – Corpo in acciaio inox, piano Schott Ceran. Thermocontrol. 12 livelli di potenza. Preselezione temperatura 60-240°C. Timer 23 ore 59'.



Induction cooker

Piastra ad induzione
Induktionsplatte
Plaque à induction
Placa de inducción

art.	cm.	Kg.	kW
18162-RA	30x37x10	6	2,7

Stainless steel body, Schott ceran surface. Timer 0-180 min. 10 power levels. Temperature range 60-240°C. – Corpo inox, piano Schott ceran. Timer 0-180 min. 10 livelli di potenza. Temperatura 60-240°C.



**Induction cooker, to be built into counter**

Piastra ad induzione da incasso
 Induktionsplatte, thekeneinbau
 Plaque à induction encastrable
 Placa de inducción para empotrar

art.	cm.	Kg.	kW
18162-RB	36X38x12,5	5,7	3,5

Schott ceran surface. Timer 0-180 min. 10 power levels. Temperature range 60-240°C. – Piano Schott ceran. Timer 0-180 min. 10 livelli di potenza. Temperatura 60-240°C.

**Induction cooker, to be built into counter**

Piastra ad induzione da incasso
 Induktionsplatte, thekeneinbau
 Plaque à induction encastrable
 Placa de inducción para empotrar

art.	cm.	Kg.	kW
49998-20	35,5x35,5x6	3,4	2

Schott ceran surface. 5 power levels. Temperature range 60-240°C. – Piano Schott ceran. 5 livelli di potenza. Temperatura 60-240°C.

**Induction station**

Stazione induzione
 Induktionsstation
 Station d'induction
 Estación inducción

art.	Ø cm.	cm.	V	W
49999-04	24	35,4x32,5x19	220-240	900

Induction plate with temperature regulator 60>140°C. Black metal support, walnut wood insert and stainless steel frame. – Piastra a induzione con regolatore di temperatura 60>140°C. Supporto in metallo nero, inserto in legno di noce e cornice inox.

**Coffee percolator**

Percolatore per caffè
 Kaffee-Perkolator
 Percolateur à café
 Percolator de café

art.	Ø cm.	h. cm.	lt.	W
49846-05	28	38,5	4,5	950
49846-09	28	38,5	9,2	950
49846-15	33	54,0	15,0	1650

**Samovar PYRAMID**

Samovar
 Samovar
 Samovar
 Samovar

art.	cm.	lt.	W
49856-04	35,5x30x45,2	4+1,2	2500

Teapot with strainer. Cable length approx. 130 cm. With 2 heating elements 2000W and 500W. – Teiera con colino. Lunghezza cavo circa 130 cm. Con 2 resistenze 2000W e 500W.

**Samovar ROMANOV**

Samovar
 Samovar
 Samovar
 Samovar

art.	cm.	lt.	W
49855-05	34x27x59	5+1,3	1800

Teapot with strainer. Cable length approx. 100 cm. With 2 heating elements 1300W and 500W. – Teiera con colino. Lunghezza cavo circa 100 cm. Con 2 resistenze 1300W e 500W.

SS

SS

SS





SS

Samovar SORAYA

Samovar
Samovar
Samovar
Samovar

art.	cm.	lt.	W
49855-10	35,2x44,5x69	10+1,6	3000

Teapot with strainer. Cable length approx. 130 cm. With 2 heating elements 2300W and 700W. – Teiera con colino. Lunghezza cavo circa 130 cm. Con 2 resistenze 2300W e 700W.



SS

Samovar KATHARINA

Samovar
Samovar
Samovar
Samovar

art.	cm.	lt.	W
49855-15	39,5x44,5x74,5	15+2	3000

Teapot with strainer. Cable length approx. 130 cm. With 2 heating elements 2300W and 700W. – Teiera con colino. Lunghezza cavo circa 130 cm. Con 2 resistenze 2300W e 700W.



SS

Chocolate fountain

Fontana cioccolato
Schokoladenbrunnen
Fontaine à chocolat
Fuente para chocolate

art.	Ø cm.	h. cm.	lt.	W
42982-08	38	80	3,5	370

230V-50Hz-Amps 1,6A. Minimum quantity of chocolate necessary for operation is about 3.5 kg, the maximum is 8 kg. – Quantità minima di cioccolato richiesta per funzionare è di circa 3,5 kg e può contenerne fino a 8 kg.



PP

SS

Soup kettle

Zuppiera
Suppenwärmer
Marmite à soupe
Marmita para sopa

art.	Ø cm.	h. cm.	lt.	W
49847-38	38	36,5	10	450-550



Soup kettle

Zuppiera
Suppenwärmer
Marmite à soupe
Marmita para sopa

art.	Ø cm.	h. cm.	lt.	W
49847-08	33	37	10	400



Raclette maker

Macchina per raclette
Raclette Tischgerät
Appareil à raclette
Máquina raclette

art.	cm.	V	W
42420-06	44,5x21,5x30	230	850

Foldable model with transport hook. 2 heating ramps, adjustable height. Suitable for cheese size 1/6 to 1/3 of a wheel. In stainless steel and painted steel. – Modello pieghevole con gancio di trasporto. 2 rampe di riscaldamento, altezza regolabile. Adatto per formaggi da 1/6 a 1/3 di una forma. In acciaio inossidabile e acciaio verniciato.



**Raclette maker**

Macchina per raclette
Raclette Tischgerät
Appareil à raclette
Máquina raclette

art.	cm.	V	W
42420-08	46x26,5x40	230	850

Tiltable and easily removable cheese holder. Heating block adjustable height. Ideal for 6-8 people, 1/2 shape. Cheese holder in stainless steel and epoxy painted steel structure. – Porta formaggio inclinabile e facilmente rimovibile. Blocco riscaldante regolabile in altezza. Ideale per 6-8 persone, 1/2 forma. Porta formaggio in acciaio inossidabile e struttura in acciaio verniciato epossidico.

**Sugar lamp**

Lampada per zucchero
Zuckerlampe
Lampe à sucre
Lámpara para azúcar

art.	cm.	Kg.
47840-11	61x41x50	6,4

Stainless steel. Infrared lamp, 3 selection powers 500-1000-1500W. Cable included. – Acciaio inox. Lampada infrarossi con 3 potenze selezionabili, 500-1000-1500W. Incl. cavo di alimentazione.



ABS

Tempering unit

Temperatrice
Temperiergerät
Tempéreuse
Templadora

art.	Ø cm.	h. cm.	lt.
47698-01	20,5	21,2	1,7

For ice cream parlours, ideal for chocolate coatings of ice creams on sticks. Can be used straight on the counter. Removable anodized aluminum tank. – Per gelaterie, ideale per coperture in cioccolato di gelati e semifreddi su stecco. Può essere utilizzato direttamente sul banco. Vasca estraibile in alluminio anodizzato.

**Raclette maker, 4 pans**

Macchina per raclette, 4 padelle
Raclette Tischgerät, 4 Pfannen
Appareil à raclette, 4 poêlons
Máquina raclette

art.	cm.	W
41318-00	51x10x12	600

Non-stick upper plate for all cooking (vegetables, meats, etc.).

Piastra superiore antiaderente per tutte le cotture (verdure, carne, ecc.).

**Spray gun**

Pistola
Sprühpistole
Pistolet
Pistola

art.	ml.	Kg.	W	rpm
47848-07	700	1,1	60	280

Usable for hot liquids max. 65 °C. Equipped with nozzle 0,6 mm.
Per liquidi caldi max. 65°C. Bocchetta in dotazione da 0,6 mm.



ABS

Tempering unit

Temperatrice
Temperiergerät
Tempéreuse
Templadora

art.	Ø cm.	h. cm.	lt.
47698-02	26	16	1,8

Mini dry melter, allows to process tiny chocolate quantities without any waste. Practical removable tank. – Mini scioglitori a secco, adatto per piccole produzioni senza sprechi. Pratica vasca estraibile.





SS
ABS

Tempering unit

Temperatrice
Temperiergerät
Tempéreuse
Templadora

art.	cm.	lt.
47698-03	40x24x13,5	3,6
47698-06	40x33x13,5	6,0

Analog tempering units. Housing made with heat-resistant plastic. Removable stainless steel tank. UK/US/JAPAN/AUSTRALIA/CHINA wirings upon request.
Temperatrici analogiche. In materiale plastico termoresistente. Vasca inox removibile. Su richiesta cablaggio GB/USA/GIAPPONE/AUSTRALIA/CINA.



SS
ABS

Tempering unit, digital

Temperatrice digitale
Temperiergerät, digital
Tempéreuse digitale
Templadora digital

art.	cm.	lt.
47698-07	40x33x13,5	6,0

Made of heat-resistant plastic material, stainless steel tank and lid, thermal probe for chocolate temperature control. Tempering manually adjustable or following the 3 programs depending on the type of chocolate: white, milk and dark. – In materiale plastico termoresistente, vasca e coperchio in acciaio inox, sonda termica per la regolazione della temperatura del cioccolato. Temperaggio regolabile manualmente o seguendo i 3 programmi in base al tipo di cioccolato: bianco, al latte e fondente.



Airbrush compressor

Compressore per penna aerografa
Airbrush Kompressor
Compresseur
Compresor

art.	cm.	W
47844-06	16x30x23	200

Cap. 4 bar.



Caramelizer

Caramellizzatore
Caramelisiert-Eisen
Carameliseur
Quemador

art.	Ø cm.	W
47847-10	10	0,65



Caramelizer

Caramellizzatore
Caramelisiert-Eisen
Carameliseur
Quemador

art.	l. cm.	W
47847-23	23	1,5



Meat mincer

Tritacarne
Fleischwolf
Hachoir
Picadora de carne

art.	cm.	Kg.	kW
49921-00	18x42x43	6	0,35



**Gravity slicing machine**

Affettatrice a gravità

Schräg Aufschnittmaschine

Trancheuse à gravité

Cortadora de gravedad

art.	Ø cm.	cm.	Kg.	rpm
49975-19	19,5	52x36x31,5	10	300
49975U19*	19,5	52x36x31,5	10	300

*Extra CE. Built-in blade sharpener. – Extra CE. Affilatoio fisso.

**Gravity slicing machine**

Affettatrice a gravità

Schräg Aufschnittmaschine

Trancheuse à gravité

Cortadora de gravedad

art.	Ø cm.	cm.	Kg.	rpm
49975-25	25	62x42,5x37	15,5	300
49975U25*	25	62x42,5x37	15,5	300

*Extra CE. Built-in blade sharpener. – Extra CE. Affilatoio fisso.

**Gravity slicing machine**

Affettatrice a gravità

Schräg Aufschnittmaschine

Trancheuse à gravité

Cortadora de gravedad

art.	Ø cm.	cm.	Kg.	rpm
49975-22	22	58x40,5x34	10	300
49975U22*	22	58x40,5x34	10	300

*Extra CE. Built-in blade sharpener. – Extra CE. Affilatoio fisso.

**Gravity slicing machine**

Affettatrice a gravità

Schräg Aufschnittmaschine

Trancheuse à gravité

Cortadora de gravedad

art.	Ø cm.	cm.	Kg.	rpm
49975-30	30	65x49,5x44	23	300
49975U30*	30	65x49,5x44	23	300

*Extra CE. Built-in blade sharpener. – Extra CE. Affilatoio fisso.

**Gravity slicing machine**

Affettatrice a gravità

Schräg Aufschnittmaschine

Trancheuse à gravité

Cortadora de gravedad

art.	Ø cm.	cm.	Kg.	rpm
49975-35	35	89x58,5x48	36	260
49975U35*	35	89x58,5x48	36	260

*Extra CE. Built-in blade sharpener. – Extra CE. Affilatoio fisso.

**Vertical slicing machine**

Affettatrice verticale

Vertikal Aufschnittmaschine

Trancheuse verticale

Cortadora vertical

art.	Ø cm.	cm.	Kg.	rpm
49974-25	25	53x52x50	24	300
49974U25*	25	53x52x50	24	300

*Extra CE. – Extra CE.





Vertical slicing machine
Affettatrice verticale
Vertikal Aufschnittmaschine
Trancheuse verticale
Cortadora vertical

art.	Ø cm.	cm.	Kg.	rpm
49974-30	30	53x52x50	27	300
49974U30*	30	53x52x50	27	300

*Extra CE. – Extra CE.



Sieve
Passaverdura
Passiergerät
Moulin
Molino

art.	Ø cm.	h. cm.	kg./H	Kg.	W
49879-37	37	108	300	23,5	600

Threephase motor 380V. Disc 3 mm. – Motore trifase 380V. Griglia 3 mm.

SS



Can opener
Apriscatole
Dosenöffner
Ouvre-boîte
Abrelatas

art.	cm.	Kg.
49814-00	44x25x75	13

Dual speed motor. Opens all can shapes from 50 to 270 mm height.
Motore a 2 velocità. Per formati scatola da 50 a 270 mm di altezza.

SS



Knife sterilizer
Sterilizzatore per coltelli
Messertentkeimer
Armoire de sterilisation
Esterilizador para cuchillos

art.	cm.	W
49871-10	57,5x17x60	15
49871-20	103x17x60	30

Plexiglas door, magnetic lock. Timer setting from 0 up to 2 hours. Door with stop device when opening. Protection IP 24. – Porta in plexiglas, chiusura magnetica. Programmabile da 0 a 2 ore. Dispositivo d'arresto all'apertura porta. Indice di protezione IP 24.

SS



Knife sharpener
Affilacoltelli
Messerschleifapparat
Aiguiseur
Afilador

art.	cm.	Kg.	W	rpm
49872-00	25x10x12	4	172	1550

ABS knife guide. Pressure sensitive motor shuts down automatically.
Guida in ABS estraibile. Motore con dispositivo autobloccante.

Etlund



Knife sharpener
Affilacoltelli
Messerschleifapparat
Aiguiseur
Afilador

art.	cm.	Kg.
49741-15	23x33x16	6,4
49741-07	23x16x16	4,6



CUCINA SENZA GLUTINE

FOR GLUTEN-FREE COOKING



UNA LINEA COMPLETA DI ARTICOLI E STRUMENTI
PROFESSIONALI FACILMENTE IDENTIFICABILI PER:

- diminuire il rischio di accidentali contaminazioni crociate degli alimenti;
- facilitare il professionista nell'operare e nell'offrire un servizio a favore del cliente con intolleranza al glutine;
- sensibilizzare il settore sul tema "gluten free" di fronte alle nuove esigenze dei consumatori.

A FULL LINE OF HORECA TOOLS AND ITEMS,
EASY TO IDENTIFY, AIMED AT:

- reducing the risk of accidental food cross-contamination;
- making it easier for professionals to work and to provide services to clients with gluten intolerance;
- raising awareness on the gluten-free diet issue in the industry so as to respond to the new needs of consumers.



Frypan
Padella

art.	Ø cm.
11014F20	20
11014F24	24
11014F28	28
11014F32	32



Cover
Coperchio

art.	Ø cm.
11161F16	16
11161F20	20
11161F24	24
11161F28	28



Baking sheet alusteel
Teglia forno, acciaio alluminato

art.	Ø cm.
11739F20	20
11739F24	24
11739F28	28
11739F32	32



Strainer with hook
Colapasta con manico e gancio

art.	Ø cm.
11924F20	20



Conical colander
Colapasta tronco conico

art.	Ø cm.
11930F24	24





One piece ladle
Mestolo unipezzo



art.	Ø cm.
11970F06	6,5
11970F08	8,0
11970F10	10



One piece skimmer
Schiumarola unipezzo



art.	Ø cm.
11971F10	10
11971F12	12



One piece perforated spatula
Paletta forata unipezzo



art.	Ø cm.
11973F10	10
11973F12	12



One piece basting spoon
Cucchiaione unipezzo



art.
11982F38



Stock pot
Pentola alta



art.	Ø cm.
12001F20	20
12001F24	24
12001F28	28



Saucepot 2 handles
Casseruola alta 2 maniglie



art.	Ø cm.
12007F16	16
12007F24	24
12007F28	28



Colander for low stock pot
Colapasta per pentola bassa



art.	Ø cm.
12123F20	20
12123F24	24
12123F28	28



Wire whip, 8 wires
Frusta 8 fili



art.	l. cm.
12928F30	30
12928F35	35



Egg whisk, 11 wires
Frusta 11 fili



art.	l. cm.
12929F30	30
12929F35	35



Gastronorm Container
Bacinella gastronorm



art.	GN	dim. cm.
14102F02	1/1	53x32,5x2
14102F04	1/1	53x32,5x4
14102F06	1/1	53x32,5x6,5
14102F10	1/1	53x32,5x10
14102F15	1/1	53x32,5x15
14102F20	1/1	53x32,5x20
14103F02	2/3	35,3x32x2
14103F04	2/3	35,3x32x4
14103F06	2/3	35,3x32x6,5
14103F10	2/3	35,3x32x10
14103F15	2/3	35,3x32x15
14103F20	2/3	35,3x32x20
14104F06	2/4	53x16,2x6,5
14104F10	2/4	53x16,2x10
14104F15	2/4	53x16,2x15
14105F02	1/2	32x26,5x2
14105F04	1/2	32x26,5x4
14105F06	1/2	32x26,5x6,5
14105F10	1/2	32x26,5x10
14105F15	1/2	32x26,5x15
14105F20	1/2	32x26,5x20
14107F06	1/3	32,5x18x6,5
14107F10	1/3	32,5x18x10
14107F15	1/3	32,5x18x15
14107F20	1/3	32,5x18x20
14108F06	1/4	26,5x16x6,5
14108F10	1/4	26,5x16x10
14108F15	1/4	26,5x16x15
14108F20	1/4	26,5x16x20
14109F06	1/6	17,6x16x6,5
14109F10	1/6	17,6x16x10
14109F15	1/6	17,6x16x15
14109F20	1/6	17,6x16x20
14110F06	1/9	17,6x11x6,5
14110F10	1/9	17,6x11x10



Gastronorm cover
Coperchio gastronorm



art.	GN
14502F00	1/1
14503F00	2/3
14504F00	2/4
14505F00	1/2
14507F00	1/3
14508F00	1/4
14509F00	1/6
14510F00	1/9



GN-lids
GN coperchi



art.	GN	dim. cm.
14922-77	1/1	53x3,25
14925-77	1/2	32,5x26,5
14927-77	1/3	32,5x17,5
14928-77	1/4	26,4x16,2
14929-77	1/6	17,6x16,2
14930-77	1/9	17,6x10,8



GN-containers
GN bacinelle



art.	GN	dim. cm.	lt.
15101-10	1/1	53x32,5x10	13,3
15105-10	1/2	32,5x26,5x10	6,1
15107-10	1/3	32,5x17,5x10	3,8
15108-10	1/4	26,4x16,2x10	2,6
15109-10	1/6	17,6x16,2x10	1,6
15110-10	1/9	17,6x10,8x10	0,9



Bread knife
Coltello pane



art.	l. cm.
18028F21	21
18028F25	25
18028F30	30
18028F36	36



Pizza wheel
Rotella tagliapizza



art.	Ø cm.
18324F10	10



Spatula perforated
Spatola pasticcio e pizza forata



art.
18510F07



Pizza turner
Spatola per pasticcio e pizza



art.
18511F15



Pastry spatula
Spatola per dolci



art.
18513F14



Perforated pizza peel, aluminum
Pala pizza forata, alluminio



art.	Ø cm.	dim. cm.	l. cm.
41704G33	-	33x33	150
41704G36	-	36x36	150



Perforated pizza peel, small
Palettino pizza forato



art.	Ø cm.	dim. cm.	l. cm.
41737G20	20	-	150
41737G23	23	-	150



Adjustable brush
Spazzola orientabile



art.	Ø cm.	dim. cm.	l. cm.
41767G20	-	20x6	160



Baking sheet alusteel
Teglia rettangolare, alluminata



art.	dim. cm.
41751F30	30x23x3
41751F40	40x30x3
41751F60	60x40x3



Cutting board
Tagliere



art.	GN	dim. cm.	col.
42522-07	-	32x26,5x2	●
42538-07	1/1	53x32,5x2	●
42539-07	-	60x40x2	●



Cutting board
Tagliere



art.	GN	dim. cm.	col.
42522F09	1/2	32x26,5x2	●
42538F09	1/1	53x32,5x2	●
42539F09	-	60x40x2	●



Labels 14 allergens
Etichette 14 allergeni



art.	dim. cm.	Pcs/Pz
44630-02	7,5x4	500

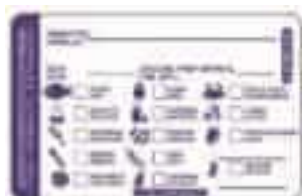

Labels Allergens
Etichette allergeni



art.	dim. cm.	Pcs/Pz
44630-06	7x4,5	500



Delivery labels with allergens
Etichette delivery con allergeni



art.	dim. cm.	Pcs/Pz
44630-07	14x4,5	250



Milk frothing thermometers, 3 pcs
Termometri latte/barista, 3 pz



art.	Ø cm.	-10+110°C	1°C
49709-03	4,5		



Digital thermometer
Termometro digitale



art.	-49,9>299,9°C	0,1/1°C
49880-17		



Bread tongs
Molla pane



art.	l. cm.
52550F63	23



Spaghetti tongs
Molla spaghetti



art.	l. cm.
52550F73	21



Toast-pastry tongs
Molla toast-dolci



art.	l. cm.
52550F78	24



Cake pliers
Pinza torta



art.	l. cm.
52550F80	28



Pastry pliers
Pinza dolci



art.	l. cm.
52550F88	18



Tap/Rubinetto : For/Per # 11102

art.
11102-99



Roasting pan grid/Griglia brasiera : For/Per # 11965

art.	dim. cm.
11966-50	50x30
11966-60	60x35
11966-61	61x43



Clutch left, Asia rectangular/Frizione sx Asia rettangolare

art.
18132-KP



Clutch right, Asia rectangular/Frizione dx Asia rettangolare

art.
18132-KQ



Clutch right Asia/Frizione dx Asia

art.	Ø cm.
18136-KQ	33-40



Clutch left, Asia/Frizione sx Asia

art.	Ø cm.
18136-KP	33
18136-KR	40



Clutch spring for rect. ABS, long side opening/Frizione molla ABS rett., apertura lato lungo

art.
18162-AF



Clutch spring for rect. ABS, short side opening/Frizione molla ABS rett., apertura lato corto

art.
18162-AG



Spare parts/Ricambi : For/Per # 18166A

art.	des	Ø cm.
18166-AD	Clutch/Frizione	24
18166-AE	Clutch/Frizione	36
18166-AF	Clutch/Frizione	40
18166-AH	Clutch/Frizione	30



Spare parts/Ricambi : For/Per # 18172A54

art.	des
18172-AF	Clutch spring/Frizione molla



Spare parts/Ricambi : For/Per # 18172A56

art.	des
18172-AG	Clutch spring/Frizione molla



Spare parts/Ricambi : For/Per # 18176A

art.	des
18176-AE	Clutch for ABS Ø cm 36/Frizione ABS Ø cm 36
18176-AF	Clutch for ABS Ø cm 40/Frizione ABS Ø cm 40
18176-AH	Clutch for ABS Ø cm 30/Frizione ABS Ø cm 30



Cutlery bag

Borsa porta coltelli

art.
18190-AA



Spare parts/Ricambi : For/Per # 18353-17

art.	des
18353-AA	Juice container/Contenitore succhi
18353-BB	Tap/Rubinetto
18353-CA	Lid/Coperchio
18353-DB	Drip bowl/Ciotola raccogli gocce
18353-VA	Eutectic pad/Contenitore eutettico



Spare parts/Ricambi : For/Per # 19810-00

art.	des
19810-AA	Blade/Lama
19810-AB	Gear/Ruota dentata



Spare porcelain/Ricambio porcellana : For/Per # 41311-00

art.
41311-AA



Folding lid/Coperchio a ribalta

art.	Ø cm.
41400-AB	23,5
41405-AB	13,5



Cereal-bar glass/Barattolo cereali, vetro : For/Per # 42460-43; 42470-43

art.	lt.
41402-AA	2



Eutectic pad/Eutettico : For/Per # 41448

art.	Ø cm.	h. cm.
41443-AE	10,5	2



Stoppers/Tappi pompa : For/Per # 41500-00

art.	Pcs/Pz
41500-AA	2



China cup/Porcellana : For/Per # 41563-07

art.
41563-AA



China cup/Porcellana : For/Per # 41564-07,

art.
41564-AA



Cheese jar/Vetro formaggiera : For/Per # 41638-01

art.	Ø cm.
41638-91	10,5



Spare parts/Ricambi : For/Per # 41638-02-04-12-13

art.	des	Ø cm.	h. cm.	lt.
41638-92	Oil/Winegar bottle/Ampolla olio/aceto	6	18,5	0,2
41638-93	Salt shaker/Spargisale - Holes/Fori 6 Ø Mm 1,85	4	9	
41638-94	Pepper shaker/Spargipepe - Holes/Fori 18 Ø Mm 1,35	4	9	
41638-95	Toothpick holder/Porta stecchi	4	9	



Brush/Spazzola : For/Per # 41767-20

art.
41767-AA



Eutectic pad/Eutettico tondo

art.	Ø cm.	h. cm.
41910-AL	15	2,5



Cover/Tappo : For/Per # 42401

art.
42401-AA



Cover/Tappo : For/Per # 42505

art.
42405-AA



Set 10 blades/Set 10 lame : For/Per # 42520-00

art.
42520-AA



Spare parts/Ricambi : For/Per # 42570-32

art.	des	mm.
42570-91	Disc/Griglia	1,5
42570-92	Disc/Griglia	2,5
42570-94	Disc/Griglia	4,0
42570-99	Cranck/Manovella	



Spare parts/Ricambi : For/Per # 42573-31

art.	des	mm.
42573-91	Disc/Griglia	1,5
42573-92	Disc/Griglia	2,5
42573-94	Disc/Griglia	4,0
42573-99	Cranck/Manovella	

Spare parts/Ricambi : For/Per # 42574-37

art.	des	mm.
42574-90	Disc/Griglia	1,0
42574-91	Disc/Griglia	1,5
42574-92	Disc/Griglia	2,0
42574-93	Disc/Griglia	3,0
42574-94	Disc/Griglia	4,0
42574-99	Cranck/Manovella	

Spare parts/Ricambi : For/Per # 42575-37

art.	des	mm.
42575-90	Disc/Griglia	1,0
42575-91	Disc/Griglia	1,5
42575-92	Disc/Griglia	2,0
42575-93	Disc/Griglia	3,0
42575-94	Disc/Griglia	4,0
42575-99	Cranck/Manovella	

Spare parts/Ricambi : For/Per # 42577-39

art.	des	mm.
42577-90	Disc/Griglia	1,0
42577-91	Disc/Griglia	1,5
42577-92	Disc/Griglia	2,0
42577-93	Disc/Griglia	3,0
42577-94	Disc/Griglia	4,0
42577-99	Cranck/Manovella	

Glass/Vetro : For/Per # 42939-15

art.
42939-AA

Wheel/Ruota : For/Per # 44023-00 # 44024-00

art.
44023-AA

Dish separation grid /Griglia divisoria : For/Per # 44027-00

art.
44027-AA



Eutectic pad/Piastra eutettica : For/Per # 44094R00

art.	des	dim. cm.
44094-RE	Temp. -32°C	13X23X3,5



Sponge/Spugna : For/Per # 44101-03

art.
44101-AA



Container/Contentitore : For/Per # 44103

art.	des
44103-AA	3 comp.
44103-AB	4 comp.
44103-AC	6 comp.



Flat mop/Frangia mop : For/Per # 44160-03

art.
44160-AA



Trolley bags/Sacchi carrello : For/Per # 44174-24

art.
44174-AA



Cream puff nozzle/Beccuccio riempi bignè : For/Per # 47612-01

art.
47612-AA



Knife insert/Inserto porta coltelli : For/Per # 48040-00 - 48040-10

art.
48040-AA



Bone-saw blade/Lama per sega : For/Per # 48231

art.	mm.
48232-40	400
48232-45	450
48232-50	500

Spare parts/Ricambi : For/Per # 49811-00



art.	des
49811-01	Cutting knife kit/Kit lama
49811-02	Blade/Lama

Spare parts/Ricambi : For/Per # 49812-00



art.	des
49812-01	Blade and wheel/Lama e ruota dentata
49811-02	Blade/Lama

Spare parts/Ricambi : For/Per # 49814-00



art.	des
49811-02	Blade/Lama
49814-01	Blade and wheel/Lama e ruota dentata

Spare parts/Ricambi : For/Per # 49818-00

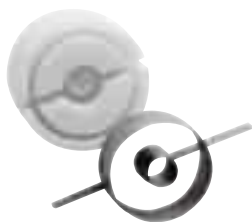

art.	des	Ø cm.
49818-AC	Blade/Lama	7,4
49818-AD	Pusher/Pressatore	7,4
49818-AE	Blade/Lama	10,2
49818-AF	Pusher/Pressatore	10,2

Set 7 blades/Set 7 lame : For/Per # 49829-11



art.
49829-BA

Spare parts/Ricambi : For/Per # 49830-60



art.	des
49830-00	Slicer/Mandolino
49830-02	Protective carriage/Carrello
49830-AA	38 Blades/Pettine 38 lame
49830-AB	44 Blades/Pettine 44 lame
49830-AC	60 Blades/Pettine 60 lame

Spare parts/Ricambi : For/Per # 49832-10



art.	des	mm.
49832-80	Pusher/Pressatore	10
49832-86	Pusher/Pressatore	6
49832-88	Pusher/Pressatore	8
49832-90	Blade/Lama	10
49832-96	Blade/Lama	6
49832-98	Blade/Lama	8

Spare parts/Ricambi : For/Per # 49834-00



art.	des
49834-01	Peeling blade/Lama a pelare
49834-02	Slicing blade/Lama affettare



Blade assembly/Set lame : For/Per # 49837-05

art.
49837-AA



Blade assembly/Set lame : For/Per # 49838-08

art.
49838-AB



Disc/Griglia : For/Per # 49879-37

art.	mm.
49879-90	1,0
49879-91	1,5
49879-92	2,0
49879-93	3,0
49879-94	4,0



Pedal & opening assembly/Pedaliera e movimento : For/Per # 49899-01

art.
49899-AA



Glass/Bicchieri : For/Per # 49956-01

art.
49956-AA



Display for fry pans/Espositore per padelle ferro

art.
XO1046

ALPHABETICAL INDEX

INDICE ALFABETICO

A			Caviar fork/spoon	401	Dunnage rack	544	
Accessories s/steel	69		Chafing dishes	501	E		
Air pot	388, 500		Chalkmarker	317	Egg basket	481	
Airbrush + compressor	211		Champagne saber	405	Egg cup	391	
Ananas corer	109, 137		Champagne stopper	357	Egg rings	138	
Appetizer platters	367		Changing table	538	Egg separator	115	
Apple corer/peeler	111, 114, 138		Cheese jar	396	Egg slicer/top cutter	138	
Appolia baking dishes	438		Cheese shaker	397	Emulsifier	555	
Apron	185, 353		Cheese slicer	108, 112	Enamelled cast iron cookware	60	
Artichoke corer	139		Chef's torch	212	Enamelled cast iron mini cookware	35	
Ashtray	407		Chinese colander	135	Escargot dish	401	
Asparagus peeler	109		Chocolate/cocktail fountain	473	Ethnic cuisine	277	
Asparagus pot	46		Chopsticks	285	Eutectic pad	493	
Avocado cutter/slicer	139		Cigar ashtray	408	F		
B			Cigar case	408	Finger food dishes	373	
Baguette basket	480		Cigar cutter	408	Fish kettle	26, 57, 70	
Bain-marie	26, 57, 71		Citrus stripper	111	Fish scaler	107	
Baker's blades	275		Cocktail picks	179, 286, 358	Flair bottle	350	
Baking paper	219		Cocktail strainer	336	Flavour marker	317	
Bar items	327		Cocoa dredger	306	Flexiform	269	
Bar mat	352		Coffee percolator	507	Flexipan	255	
Bar organizer	348		Coffee pot	303, 389	Floor sign	541	
Barman case	353		Coffee urn	506	Flour brush	218	
Baster tube	125		Cognac warmer	405	Flower vase	405	
Bell reception/table	407		Colander	71, 131	Fondue set	26, 398	
Bento box	281		Combi unit mixer/liquidiser	554	Food pan	509	
Bins	542		Condiment holder	352, 397	Forged knives s. 18100	157	
Blender	557		Contact grill	548	French fry cutter	140	
Board wall/sandwich	488		Conveyor Toaster	547	Fruit basket	343, 392	
Bone-saw	181		Cookie press	207	Fryer	550	
Boston cone	340		Cooking tongs	125, 335	Fuel holder	68, 509	
Bottle cooler	404, 402		Cookware s. 1000 s/steel	41	Funnel	128, 210	
Bottle opener	109, 357		Cookware s. 1100 s/steel	37	G		
Bowl	131, 133		Cookware s. 12200 s/steel 5-PLY	22	Garlic press	113, 141	
Bread baskets	392, 479		Cookware s. 12300 s/steel 3-PLY	50	Glass cleaning brush	354	
Bread box	275		Cookware s. 15300-15400 copper	26	Glass clip holder	358	
Bread cutter	487		Cookware s. 15600 copper 3-PLY	24	Glass rimmer	352	
Breakfast tray with legs	514		Cookware s. 2000 s/steel	44	Glasses	341	
Broom + dust pan	539		Cookware s. 2100 s/steel	40	Gloves	185	
Brushes	108, 113, 126, 217, 275, 292		Cookware s. 2500 s/steel 3-PLY	48	GN melamine food pans	95	
Bucket with wringer	541		Cookware s. 6100 aluminum	53	GN polycarbonate food pans	84	
Buffet baskets/crates	489		Core stripper	141	GN polypropylene food pans	88	
Buffet display	472		Cream dispenser	210	GN porcelain food pans	97	
Buffet stand	470, 490, 498		Cream whipper	324	GN s/steel food pans	74	
Buffet trays	464, 471		Crepe machine	550	GN trays	359, 493	
Butcher trays	181		Croissant cutter	215	GN Tritan food pans	86	
Butchers table	184		Cutlery box	397, 481, 518	Graduated bucket	132	
Butter churn	144		Cutting board rack	185	Graduated jug	128	
Butter cup	392		Cutting boards PE	183	Graters	113, 144	
Butter curler	110, 115		D			Gravy boat	392
Butter spreader	108		Dash bottle	349	Griddle plate	65, 399	
Butter warmer	29		Decorating carving tools	143	Grill pan	64	
C			Dehydrator	552	Guitar	214	
Cake marker	216		Delivery bag	297	H		
Cake pans aluminum	226		Dining room trolleys	511	Ham stand	181	
Cake pans non stick	228		Dish dolly	519	Hamburger press	182	
Cake stand	309		Dish racks	516	Hangiri/sushi rice tub	287	
Can opener	109, 114, 145, 566		Dish-warmer	551	Heating units	510	
Candelabra	405		Display cases	313, 491, 551	Hooks	180	
Candleholder	406		Display tray	181, 218	Housekeeping cart	539	
Canister with lid	497		Disposable glasses	320, 321, 322	I		
Caramelising rod	211		Dolly	518, 542	Ice box	347, 492	
Caramelizer	210, 564		Dome cover	309, 348, 467	Ice chisels	143	
Cash tray	308		Drainer plate	83	Ice cream basin	315	
Caviar cooler	401		Draining rack	208, 519	Ice cream cone holder	318	

Ice cream cup	319	O	Soup tureen	507, 562	
Ice cream maker	551	Octopus press	136	Sous vide cooker	560
Ice cream scoop	315	Oil pourer	288	Spatulas	102, 118, 124
Ice crusher	345, 559	Orange juicer	344, 556	Spoon holder	306
Ice dipper	114, 316	Oven dishes	72, 438	Spray gun	211
Ice molds	346	Oyster plate	473	Sprayer oil/vinager	396
Icing bag	206	P	Squeeze bottle	129	
Induction adapter	134	Pans non-stick coated	56	Steamer	287
Induction cooker	508	Party tub	474	Stirrers	334
Infrared lamp	553	Pastry cutters s/steel	189	Straws	333
Insulated container	296	Pastry rings micro-perforated	222	String holder	181
Iron pans	58	Pastry stand	382, 344	Sturdy chair	538
J		Pastry wheel	107, 215	Sugar bag holder	307
Japanese knives	176	Pedal bin	539, 543	Sugar dredger	218, 306
Jar opener	113	Pepper/salt mills	409	Sugar lamp	211
Jelly fuel	510	Peugeot	409	Swivel peeler	110
Jigger	337	Piping tip adapter	205	Syrup density meter	213
Jug	342, 389	Pizza delivery bag	298	T	
Juice/cereal dispensers	498	Pizza items	291	Tab-grabber	127
K		Pizza pans	299	Table cloth clips	397
Kitchen needles	179	Pizza peels	291	Table crumbler	398
Kitchen utensils	101	Pizza screens	298	Table sign	406
Knife block	178	Pizza wheel	294	Table top cutter	552
Knife case	177	Placemats	380	Table top waste bin	400
Knife sharpener	177, 566	Planetary mixer	559	Tastevin	405
Knife sterilizer	179	Plate cover	127	Tea bag holder	307
L		Potato masher	113	Tea pot	284, 303
Labels	155	Potato peeler	110	Tea strainer	391
Ladles	121	Potato ricer	140	Thermic hot box	513
Lemon squeezer	344	Poultry scissors	173	Thermometers	148
Lobster cracker/pick	400	Pourer	355	Tiki mugs	332
M		Presse canard	136	Tilt truck	544
Magnetic knife rack	178	Punch bowl	474	Toast rack	391
Mandoline	141	R		Tomato cutter	136
Marinating syringe	125	Rack	126, 299, 353	Tomato juicer sieve	146
Measuring cups/spoon	128	Raclette maker	398	Tomato peeler	110
Meat mincer	564	Rechaud	284, 399	Toothpicks	358
Meat tenderizer	181	Roasting pan	57, 70	Trays non-slip	359
Mechanical sweeper	539	Rolling pin	215	Trays s/steel	476
Melon baller	109, 114	S		Trivet	36, 62, 400
Menu holder	406	Salad spinner	134	Truffle slicer	394
Microwave oven	560	Salamander	549	V	
Milk pot	307	Salami pricker	177	Vegetable cutter	137
Mini cookware s. 12200 s/steel 3-PLY	30	Salt shaker	395	Vegetable mills/slicer	146, 566
Mini cookware s. 15600 copper 3-PLY	28	Samovar	506	Vegetable peeler	139
Mini cookware s. 16130 aluminum	32	Sausage filler	182	W	
Mini cookware s. 16140 aluminum	33	Scales	155, 156	Waffle iron	552
Mini cookware s. 41210 stoneware	34	Scissors	173	Wall clock	155
Mirrors acrylic	478	Scoop	130, 345	Warming display	551
Mixer	554	Scraper	301	Warming plate	554
Mixing bowl	26, 133	Seafood tray	401	Wasabi grater	288
Mixing glass	340	Serving trolley	511, 538	Waste bin	542
Molds polycarbonate	237	Shaker	339	Weck jars/glasses	386
Molds silicone	236, 251	Sharpening steel	172	Whisk	105
Mop	540	Shearing knives s. 18000	160	Whistling kettle	71, 550, 559
Mortar	288	Showplate cooled	492	Wine bucket stand	403
Moscow mule mug	329	Sieves	130, 218	Wine buckets	402
Mustard cup	392	Sieving juicer	555	Wine holder	405
N		Skimmer	103, 122	Wine vacuum pump	357
Napkin holder	308, 317, 397	Slate items	381	Wire cutter	140, 213
Newspaper stick	407	Slicing machine	182, 565	Wok pan	33, 49, 59, 287
Nitro Whip	305	Smoker	552	Wooden cutting boards	367
Nozzles	199, 204	Smoking chips/gun	348	Z	
Nut craker	400	Snacks holders	364	Zucchini corer	109
Nutmeg mill	432	Soda siphon	344		

A			
Acciaio	172	Cavalletto segnalatore	541
Accumulatore di freddo	493	Cavatappi	357
Adattatore induzione	134	Centrifuga	134, 555
Adattatore per bocchette	205	Ceppa	184
Affetta formaggio	108, 112	Ceppo portacoltelli	178
Affetta mozzarella/pomodori	136	Cesta baguettes	480
Affettatrice	182, 565	Cesta pane	275
Affilacoltelli	177, 566	Cestelli lavabicchieri	516
Affumicatoio	552	Cesti pane	392, 479
Affumicatore	348	Cesti/casse buffet	489
Aghi cucina	179	Cesto frutta	343, 392
Alzata torta	309	Cesto uova	481
Alzate buffet	469, 495	Chafing dishes	501
Alzate dolci	382, 344	Chitarra	214
Anelli uova	138	Clip reggibicchiere	358
Apribarattoli	113	Cloche	309, 348
Apriscatole	109, 114, 145, 566	Colapasta	71, 131
Apriuovo	138	Colino cocktail	336
Ardesia	381	Colonna portasecchiello	403
Arricciaburro	110, 115	Coltelli forgiati s. 18100	157
Aspirapolvere meccanico	539	Coltelli giapponesi	176
Asta porta scontrini	127	Coltelli tranciati s. 18000	160
Attrezzi decoro	143	Combi mixer/frusta	554
B		Complementi inox	69
Bacchette cinesi	285	Compressore	211
Bacinella	131, 133	Cono boston	340
Bacinella gelato	315	Contentitore isotermico	296
Bagnomaria	26, 57, 71	Coppa burro	392
Bar	327	Coppa caviale	401
Barattolo vetro	497	Coppa gelato	319
Barbecue da tavola	65, 399	Coppa punch	474
Barra magnetica	178	Copripiatto	127
Bastardella	26, 133	Cornetto cinese	135
Batticarne	181	Cottura sottovuoto	560
Benna	544	Crepiera	550
Bicchiere miscelatore	340	Cucina etnica	277
Bicchieri	341	Cuociasparagi	46
Bicchierini monouso	320, 321, 322	Cuocivapore	287
Bidone	542	Cutter da tavolo	552
Bilance	155, 156	D	
Bistecchiera	64	Disidratatore	552
Bocchette decorative	199, 204	Display per buffet	472
Bollitore	71, 550, 559	Distributori succhi/cereali	498
Bordatore	352	Dosa creme	210
Borsa isoterma	297	E	
Bottiglia angostura	349	Espositore buffet	470, 498
Box portaghiaccio	492	Etichette	155
Box termico	513	F	
Brasiera	57, 70	Fasce microforate	222
C		Fasciatoio	538
Caffettiera	303, 389	Ferma prosciutto	181
Campana	310, 467	Fermatovaglia	397
Campanella	407	Finger food	373
Candelabro	405	Flacone	129
Cannello	212	Flair bottle	350
Cannucce	333	Flexiform	269
Caraffa	342, 389	Flexipan	255
Caraffa graduata	128	Fonduta	26, 398
Caraffa termica	388, 500	Fontana cioccolato/cocktails	473
Caramellizzatore	210, 564	Forbici	173
Carapina	315	Formaggiera	396
Carrelli sala	511	Friggitrice	550
Carrello	518, 542	Frullatore	557
Carrello di servizio	511, 538	Frusta	105
Carrello lavapavimenti	541	G	
Carrello portabiancheria	539	Ganci	180
Carrello portapiatti	519	Gel combustibile	510
Carta da forno	219	Glacette	404
		GN inox	74
		GN melamina	95
		GN policarbonato	84
		GN polipropilene	88
		GN porcellana	97
		GN Tritan	86
		Grattugia wasabi	288
		Grattugie	113, 144
		Grembiule	185, 353
		Griglia di colaggio	208
		Griglia in filo	83
		Grill a contatto	548
		Guanti	185
		I	
		Imbuto	128, 210
		Insacatrice	182
		L	
		Lame panettiere	275
		Lampada infrarossi	553
		Lampada zucchero	211
		Lattiera	307
		Lavagna	488
		Legatovagliolo	397
		Levacapsule	109, 358
		Levatorsoli	111, 114
		Lira	140, 213
		M	
		Macchina gelato	551
		Macchina per cialde	552
		Macchina raclette	398
		Macina noce moscata	432
		Macinapepe/sale	409
		Mandolino	141
		Mestoli	121
		Microonde	560
		Miscelatori cocktail	334
		Misurini	128
		Misurino cocktail	337
		Mixer	554
		Mop	540
		Mortaio	288
		N	
		Nebulizzatore olio/acetato	396
		O	
		Oliera	288
		Omogeneizzatore	555
		Orologio da parete	155
		P	
		Padelle antiaderenti	56
		Padelle ferro	58
		Pale pizza	291
		Passapomodoro	146
		Passath	391
		Passaverdura	146, 566
		Pattumiera	539, 543
		Pedana	544
		Pela asparagi	109
		Pela mele	138
		Pelapatate	110
		Pelapomodori	110
		Pelaverdure	139
		Penna aerografa	211
		Penna gesso liquido	317
		Pennelli	108, 113, 217
		Pentolame ghisa smaltata	60
		Pentolame miniature ghisa smaltata	35
		Pentolame miniature s. 12200 inox 3-PLY	30
		Pentolame miniature s. 15600 rame 3-PLY	28
		Pentolame miniature s. 16130 alluminio	32
		Pentolame miniature s. 16140 alluminio	33

Pentolame miniature s. 41210 stoneware	34	S		Svuota carciofi	139
Pentolame s. 1000 inox	41	Sacchetto per decorare	206	Svuota zucchine	109
Pentolame s. 1100 inox	37	Salamandra	549	T	
Pentolame s. 12200 inox 5-PLY	22	Salsiera	392	Taglia ananas	137
Pentolame s. 12300 inox 3-PLY	50	Samovar	506	Taglia avocado	139
Pentolame s. 15300-15400 rame	26	Sbucciatore	110	Taglia croissants	215
Pentolame s. 15600 rame 3-PLY	24	Scaldaburro	29	Taglia pane	487
Pentolame s. 2000 inox	44	Scaldacaff-	506	Taglia patate	140
Pentolame s. 2100 inox	40	Scaldacognac	405	Taglia uova	138
Pentolame s. 2500 inox 3-PLY	48	Scaldapiatti	551	Taglia verdure	137
Pentolame s. 6100 alluminio	53	Scaldavivande	501	Tagliapasta inox	189
Percolatore	507	ScalPELLI ghiaccio	143	Tagliasigari	408
Pesa sciroppo	213	Scatola bento	281	Tagliatartufi	394
Pesciera	26, 57, 70	Scavino	109, 114	Tagliaverdure	556
Pestaghiaccio	345	Schiaccianoci	400	Taglieri legno	367
Peugeot	409	Schiacciapotate	140	Taglieri PE	183
Piano caldo	554	Schiumarola	103, 122	Tappeto bar	352
Piastra ad induzione	508	Sciabola Sommelier	405	Tappo dosatore	355
Piastre elettriche	510	Scolapiatti	519	Tappo spumante	357
Piatto frutti di mare	473	Scopa a forcice	539	Targhetta tavola	406
Piatto lumache	401	Secchi vino	402	Tastevin	405
Pinza	125, 335	Secchio	132	Tazza moscow mule	329
Pinza aragosta	400	Secchio con strizzatore	541	Teglie pizza	299
Pirofile Appolia	438	Secchio ghiaccio	347	Teiera	284, 303
Pirofile forno	72, 438	Secchio portabottiglie	474	Temperatrice	211
Pistola elettrica	211	Sega per ossa	181	Termometri	148
Pizza	291	Segatura aromatizzata	348	Tiki mug	332
Planetaria	559	Seggiolone	538	Tortiere alluminio	226
Pompa sottovuoto	357	Segnagusto	317	Tortiere antiaderenti	228
Pompetta per sugo	125	Segnaporzioni	216	Tostapane	547
Porta coltelli	178	Senapiera	392	Tovaglette	380
Porta coni	318	Separauova	115	Trinciapollo	173
Porta cucchiaini	306	Servitartufi	395	Tritacarne	564
Porta men	406	Sessola	130, 345	Tritaghiaccio	345, 559
Porta oggetti bar	348	Setacci	130, 218	U	
Porta posate	397, 481, 518	Shaker	339	Utensili cucina	101
Porta rifiuti	400, 542	Sifone nitro	305	V	
Porta sigaro	408	Sifone panna	324	Valigia Barman	353
Porta snack	364	Sifone soda	344	Valigia cuoco	177
Porta spago	181	Siringa per marinata	125	Vasca hangiri	287
Porta taglieri	185	Siringa per pasticceria	207	Vasetti Weck	386
Porta tovaglioli	308, 317	Snocciolatore	141	Vaso fiori	405
Portabustine th-/zucchero	307	Sottopentola	36, 62, 400	Vassoi appetizer	367
Portacandela	406	Spalmaburro	108	Vassoi buffet	464, 471
Portacombustibile	68, 509	Spargi zucchero	218, 306	Vassoi GN	359, 493
Portacondimenti	352, 397	Spargicacao	306	Vassoi inox	476
Portagiorinale	407	Spargiformaggio	397	Vassoi macelleria	181
Portatoast	391	Spargisale	395	Vassoio antiscivolo	359
Portauovo	391	Spatola gelato	315	Vassoio conto	308
Portavivande	509	Spatole	102, 118, 124	Vassoio espositore	181, 218
Porzionatore	114, 316	Spazzola lavabicchieri	354	Vassoio frutti di mare	401
Posacenere	407	Spazzola per farina	218	Vassoio room service	514
Posate caviale	401	Spazzole	126, 275, 292	Versavino	405
Pressa-hamburger	182	Specchi acrilico	478	Vetrina da banco	313
Pressapatate	113	Spiedini cocktail	179, 286, 358	Vetrina refrigerata	492
Pressapolipo	136	Spremiaglio	113, 141	Vetrina riscaldata	551
Presse canard	136	Spremiagrumi	344, 556	Vetrina sigari	408
Pungisalame	177	Spremillimone	344	Vetrine	491, 551
R		Spumantiera	402	W	
Raccoglibriciole	398	Squamapesce	107	Waffels	268
Raschia	301	Stampi ghiaccio	346	Weck	386
Rastelliera	126, 299, 353	Stampi policarbonato	237	Wok	33, 49, 59, 287
Rechaud	284, 399	Stampi silicone	236, 251	Z	
Retine pizza	298	Stampo burro	144	Zaino isoteramico	298
Rigalimoni	111	Sterilizzatore	179	Zuppiera	507, 562
Rompighiaccio	345	Stiletto aragosta	400		
Rotella taglia pizza	294	Stuzzicadenti	358		
Rotelle taglia pasta	107, 215	Supporto buffet	490		
Rullo	215	Svuota ananas	109, 137		

NUMERICAL INDEX

INDICE NUMERICO

NUMERISCH INDEX

INDEX NUMERIQUE

INDICE NUMERICO

NUMERICAL INDEX INDICE NUMERICO NUMERISCH INDEX INDEX NUMERIQUE INDICE NUMERICO

Cod.	pag.	Cod.	pag.	Cod.	pag.	Cod.	pag.	Cod.	pag.	Cod.	pag.	Cod.	pag.
11001-16	42	11014F20	567	11113-26	39	11713-32	59	11910-12	71	11952-36	133	11974-50	121
11001-18	42	11014F24	567	11114-20	39	11713-40	59	11910-14	71	11952-40	133	11974-70	121
11001-20	42	11014F28	567	11114-24	39	11714-20	59	11910-16	71	11953-16	134	11975-01	122
11001-22	42	11014F32	567	11114-28	39	11714-22	59	11910-18	71	11953-22	134	11975-50	122
11001-24	42	11061-12	43	11114-32	39	11714-24	59	11910-20	71	11954-26	134	11975-99	122
11001-28	42	11061-16	43	11114-36	39	11714-26	59	11911-12	71	11954-30	134	11976-50	122
11001-32	42	11061-18	43	11114-40	39	11714-28	59	11911-14	71	11954-32	134	11976-99	122
11001-36	42	11061-20	43	11114-45	39	11714-32	59	11911-16	71	11954-36	134	11982-01	122
11001-40	42	11061-22	43	11115-20	39	11714-36	59	11911-18	71	11954-37	134	11982-38	121
11001-45	42	11061-24	43	11115-24	39	11714-40	59	11911-20	71	11954-40	134	11982F38	568
11001-50	42	11061-28	43	11115-28	39	11714-45	59	11913-16	71	11955-32	131	11983-37	121
11001-60	42	11061-32	43	11115-32	39	11714-50	59	11913-20	71	11955-36	131	11983-38	121
11006-12	43	11061-36	43	11115-36	39	11715-12	36	11913-24	71	11955-40	131	11984-38	121
11006-14	43	11061-40	43	11115-40	39	11716-16	59	11913-28	71	11955-45	131	11985-34	122
11006-16	43	11061-45	43	11115-45	39	11716-20	59	11922-36	71	11955-50	131	11990-16	123
11006-18	43	11061-50	43	11115-50	39	11716-22	59	11922-40	71	11956-37	474	11991-16	123
11006-20	43	11101-16	38	11117-20	39	11716-24	59	11924-18	132	11956-42	474	12001-16	45
11006-22	43	11101-20	38	11117-24	39	11716-26	59	11924-20	132	11957-20	131	12001-18	45
11006-24	43	11101-24	38	11117-28	39	11716-28	59	11924-22	132	11957-25	131	12001-20	45
11006-28	43	11101-28	38	11117-32	39	11716-32	59	11924-24	132	11957-30	131	12001-22	45
11006-32	43	11101-32	38	11117-36	39	11716-36	59	11924-28	132	11957-35	131	12001-24	45
11006-36	43	11101-36	38	11117-40	39	11716-40	59	11924F20	567	11957-40	131	12001-28	45
11007-16	42	11101-40	38	11119-20	38	11716-45	59	11926-22	132	11965-50	70	12001-32	45
11007-18	42	11101-45	38	11119-28	38	11717-34	59	11926-26	132	11965-60	70	12001-36	45
11007-20	42	11101-50	38	11123-20	38	11717-37	59	11927-24	131	11965-61	70	12001-40	45
11007-22	42	11102-28	38	11123-24	38	11717-42	59	11927-28	131	11966-50	573	12001-45	45
11007-24	42	11102-32	38	11123-28	38	11717-47	59	11927-32	131	11966-60	573	12001-50	45
11007-28	42	11102-36	38	11161-12	39	11718-20	58	11927-36	131	11966-61	573	12001-60	45
11007-32	42	11102-40	38	11161-14	39	11718-22	58	11927-40	131	11967-06	121	12001F20	568
11007-36	42	11102-45	38	11161-16	39	11718-24	58	11927-45	131	11967-08	121	12001F24	568
11007-40	42	11102-50	38	11161-18	39	11739-20	299	11927-50	131	11967-09	121	12001F28	568
11007-45	42	11102-99	573	11161-20	39	11739-24	299	11928-32	131	11967-10	121	12007-16	45
11007-50	42	11105-20	38	11161-22	39	11739-28	299	11928-36	131	11967-12	121	12007-18	45
11007-60	42	11105-24	38	11161-24	39	11739-32	299	11928-40	131	11967-14	121	12007-20	45
11008-16	43	11105-28	38	11161-28	39	11739F20	567	11929-20	135	11967-16	121	12007-22	45
11008-18	43	11105-36	38	11161-32	39	11739F24	567	11929-24	135	11967-18	121	12007-24	45
11008-20	43	11106-14	38	11161-36	39	11739F28	567	11930-24	131	11967-20	121	12007-28	45
11008-24	43	11106-16	38	11161-40	39	11739F32	567	11930-28	131	11967-24	121	12007-32	45
11008-28	43	11106-20	38	11161-45	39	11740-14	299	11930-32	131	11968-18	121	12007-36	45
11008-32	43	11106-24	38	11161-50	39	11740-16	299	11930-36	131	11968-20	121	12007-40	45
11008-36	43	11106-28	38	11161-60	39	11740-18	299	11930-40	131	11968-24	121	12007-45	45
11009-16	42	11106-32	38	11161F16	567	11740-20	299	11930-45	131	11969-02	122	12007-50	45
11009-18	42	11106-36	38	11161F20	567	11740-22	299	11930-50	131	11969-06	121	12007-60	45
11009-20	42	11107-16	38	11161F24	567	11740-24	299	11930F24	567	11969-37	121	12007F16	568
11009-24	42	11107-20	38	11161F28	567	11740-26	299	11932-20	135	11970-01	122	12007F24	568
11009-28	42	11107-24	38	11617-20	56	11740-28	299	11932-24	135	11970-06	121	12007F28	568
11009-32	42	11107-28	38	11617-24	56	11740-30	299	11941-35	70	11970-08	121	12009-16	45
11009-36	42	11107-32	38	11617-28	56	11740-32	299	11941-40	70	11970-09	121	12009-18	45
11009-40	42	11107-36	38	11617-32	56	11740-36	299	11941-45	70	11970-10	121	12009-20	45
11009-45	42	11107-40	38	11617-36	56	11740-40	299	11941-50	70	11970-11	121	12009-24	45
11009-50	42	11107-45	38	11617-40	56	11741-20	299	11941-60	70	11970-12	121	12009-28	45
11009-60	42	11107-50	38	11701-02	291	11741-24	299	11943-40	70	11970-14	121	12009-32	45
11010-16	42	11108-16	38	11701-06	291	11741-26	299	11943-45	70	11970-16	121	12009-36	45
11010-18	42	11108-20	38	11701-10	291	11741-28	299	11943-50	70	11970F06	568	12009-40	45
11010-20	42	11108-24	38	11701-13	291	11741-32	299	11943-60	70	11970F08	568	12009-45	45
11010-24	42	11108-28	38	11701-16	291	11742-16	299	11943-61	70	11970F10	568	12009-50	45
11011-16	43	11108-32	38	11702-02	291	11742-18	299	11944-40	70	11971-01	123	12009-60	45
11011-18	43	11108-36	38	11702-06	291	11742-20	299	11944-45	70	11971-08	122	12037-16	46
11011-20	43	11109-16	38	11702-10	291	11742-22	299	11944-50	70	11971-10	122	12101-16	40
11011-24	43	11109-20	38	11702-16	291	11742-24	299	11944-60	70	11971-12	122	12101-20	40
11012-16	42	11109-24	38	11704-02	291	11742-26	299	11944-61	70	11971-14	122	12101-24	40
11012-18	42	11109-28	38	11704-06	291	11742-28	299	11948-40	70	11971-16	122	12101-28	40
11012-20	42	11109-32	38	11704-13	291	11742-30	300	11948-45	70	11971-18	122	12101-32	40
11012-24	42	11109-36	38	11704-16	291	11742-32	300	11948-50	70	11971-20	122	12101-36	40
11013-18	42	11109-40	38	11705-02	291	11742-36	300	11948-60	70	11971-25	122	12101-40	40
11013-20	42	11109-45	38	11705-06	291	11742-40	300	11948-61	70	11971F10	568	12101-45	40
11013-24	42	11109-50	38	11705-10	291	11742-45	300	11951-22	133	11971F12	568	12101-50	40
11013-26	42	11112-16	39	11705-14	291	11742-50	300	11951-26	133	11972-10	122	12107-16	40
11014-20	43	11112-18	39	11706-02	291	11742-60	300	11951-32	133	11972-12	122	12107-20	40
11014-24	43	11112-20	39	11706-06	291	11744-20	299	11951-36	133	11973-01	122	12107-24	40
11014-28	43	11112-24	39	11706-10	291	11744-24	299	11951-40	133	11973-10	122	12107-28	40
11014-32	43	11113-18	39	11706-14	291	11744-28	299	11952-22	133	11973-12	122	12107-32	40
11014-36	43	11113-20	39	11710-AA	59	11744-32	299	11952-26	133	11973F10	568	12107-36	40
11014-40	43	11113-24	39	11710-AB	59	11760-11	83	11952-32	133	11973F12	568	12107-40	40

Cod.	pag.	Cod.	pag.	Cod.	pag.	Cod.	pag.	Cod.	pag.	Cod.	pag.	Cod.	pag.
12107-45	40	12303Y16	51	12550-73	458	12640-24	124	12940-05	130	14103F15	569	14152-06	78
12107-50	40	12303Y20	51	12550-74	458	12640-28	124	12940-10	130	14103F20	569	14152-10	78
12109-16	40	12303Y24	51	12550-77	458	12641-14	124	12940-20	130	14104-06	76	14152-15	78
12109-20	40	12304B26	51	12550-78	458	12641-16	124	12940-25	130	14104-10	76	14152-20	78
12109-24	40	12304G26	51	12550-80	458	12641-18	124	12947-02	198	14104-15	76	14155-10	78
12109-28	40	12304O26	51	12550-81	458	12641-20	124	12947-03	198	14104F06	569	14155-15	78
12109-32	40	12304W26	51	12550-83	458	12641-24	124	12947-04	198	14104F10	569	14155-20	78
12109-36	40	12304Y26	51	12550-84	458	12641-28	124	12947-05	198	14104F15	569	14157-10	78
12109-40	40	12504-20	127	12550-85	458	12642-28	124	12947-06	198	14105-02	76	14157-15	78
12109-45	40	12507-24	49	12550-87	458	12903-30	102	12947-07	198	14105-04	76	14157-20	78
12109-50	40	12507-28	49	12550-88	458	12903-40	102	12947-13	190	14105-06	76	14158-10	78
12123F20	568	12508-24	49	12550-89	458	12903-45	102	12967-06	104	14105-10	76	14158-15	78
12123F24	568	12509-20	49	12561-16	49	12905-25	102	12967-10	104	14105-15	76	14158-20	78
12123F28	568	12509-24	49	12561-18	49	12905-30	102	12968-10	104	14105-20	76	14159-10	78
12206-09	31	12509-28	49	12561-20	49	12905-35	102	12969-06	104	14105F02	569	14159-15	78
12206-10	31	12511-16	49	12561-24	49	12905-40	102	12969-10	104	14105F04	569	14159-20	78
12206-12	31	12511-18	49	12561-26	49	12905-45	102	12970-06	104	14105F06	569	14162-02	78
12206-16	23	12511-20	49	12561-28	49	12905-50	102	12970-08	104	14105F10	569	14162-04	78
12206-18	23	12511-24	49	12580-11	131	12906-35	102	12970-10	104	14105F15	569	14162-06	78
12206-20	23	12513-16	49	12580-17	131	12907-07	102	12970-12	104	14105F20	569	14165-02	78
12207-10	31	12513-18	49	12580-21	131	12907-08	102	12971-10	105	14107-06	76	14165-04	78
12207-24	23	12513-20	49	12580-24	131	12908-30	102	12971-12	105	14107-10	76	14165-06	78
12207-28	23	12513-24	49	12580-29	131	12908-35	102	12972-10	105	14107-15	76	14201-02	79
12208-16	23	12514-24	49	12580-30	131	12908-40	102	12972-12	105	14107-20	76	14201-04	79
12208-20	23	12514-26	49	12580-31	131	12909-12	102	12973-10	105	14107F06	569	14201-06	79
12208-24	23	12514-28	49	12580-36	131	12909-23	102	12973-12	105	14107F10	569	14201-10	79
12208-28	23	12514-32	49	12580-40	131	12915-25	102	12986-01	104	14107F15	569	14201-15	79
12211-12	31	12514-36	49	12580-45	131	12915-26	102	12986-38	104	14107F20	569	14201-20	79
12214-12	31	12517-24	49	12580-50	131	12915-35	102	14001-09	516	14108-06	76	14202-02	79
12214-20	23	12517-26	49	12582-13	131	12915-45	102	14001-16	516	14108-10	76	14202-04	79
12214-26	23	12517-28	49	12582-17	131	12916-25	102	14001-25	516	14108-15	76	14202-06	79
12214-30	23	12517-32	49	12582-22	131	12916-33	102	14001-36	516	14108-20	76	14202-10	79
12214-36	23	12517-36	49	12582-24	131	12920-01	103	14001-49	516	14108F06	569	14202-15	79
12215-12	31	12529-32	49	12582-32	131	12920-05	103	14003-09	516	14108F10	569	14202-20	79
12215-16	31	12550-01	460	12582-34	131	12920-10	103	14003-16	516	14108F15	569	14203-06	79
12217-20	23	12550-02	459	12582-38	131	12920-11	103	14003-25	516	14108F20	569	14203-10	79
12217-26	23	12550-03	461	12582-40	131	12920-15	103	14003-36	516	14109-06	76	14203-15	79
12217-30	23	12550-04	345	12604-22	130	12920-16	103	14003-49	517	14109-10	76	14203-20	79
12217-36	23	12550-05	461	12604-30	130	12921-01	103	14004-00	517	14109-15	76	14205-02	79
12238-17	31	12550-06	461	12604-34	130	12921-05	103	14006-00	517	14109-20	76	14205-04	79
12238-30	23	12550-07	461	12604-40	130	12921-10	103	14007-00	517	14109F06	569	14205-06	79
12238-35	23	12550-09	461	12605-22	130	12921-15	103	14008-00	517	14109F10	569	14205-10	79
12243-12	31	12550-11	459	12605-30	130	12926-35	105	14010-00	517	14109F15	569	14205-15	79
12261-10	31	12550-12	459	12605-34	130	12927-35	105	14011-00	517	14109F20	569	14205-20	79
12261-12	31	12550-13	459	12605-40	130	12927-45	105	14013-00	517	14110-06	76	14252-06	79
12261-16	23	12550-14	459	12606-30	130	12928-25	105	14015-08	517	14110-10	76	14252-10	79
12261-18	23	12550-15	460	12606-34	130	12928-30	105	14101-02	75	14110F06	569	14252-15	79
12261-20	23	12550-16	460	12607-22	131	12928-35	105	14101-04	75	14110F10	569	14252-20	79
12261-24	23	12550-17	460	12607-30	131	12928-40	105	14101-06	75	14112-10	77	14255-06	79
12261-28	23	12550-19	461	12607-34	131	12928-45	105	14101-10	75	14112-15	77	14255-10	79
12300-18	52	12550-20	460	12622-07	134	12928-50	105	14101-15	75	14112-20	77	14255-15	79
12300-24	52	12550-21	460	12622-10	134	12928-55	105	14101-20	75	14115-10	77	14255-20	79
12300B18	52	12550-22	459	12622-12	134	12928-60	105	14102-02	75	14115-15	77	14301-02	81
12300B24	52	12550-25	460	12622-14	134	12928F30	568	14102-04	75	14115-20	77	14301-04	81
12300G18	52	12550-26	460	12622-16	134	12928F35	568	14102-06	75	14117-10	77	14301-06	81
12300G24	52	12550-30	460	12622-18	134	12929-25	105	14102-10	75	14117-15	77	14302-02	81
12300O18	52	12550-33	460	12622-20	134	12929-30	105	14102-15	75	14117-20	77	14302-04	81
12300O24	52	12550-34	459	12622-23	134	12929-35	105	14102-20	75	14118-10	77	14302-06	81
12300W18	52	12550-36	460	12622-26	134	12929-40	105	14102F02	569	14118-15	77	14303-02	81
12300W24	52	12550-43	460	12630-22	134	12929-45	105	14102F04	569	14118-20	77	14303-04	81
12300Y18	52	12550-50	458	12633-16	134	12929F30	569	14102F06	569	14119-10	77	14303-06	81
12300Y24	52	12550-53	459	12633-18	134	12929F35	569	14102F10	569	14119-15	77	14305-02	81
12303B16	51	12550-54	459	12633-20	134	12930-51	103	14102F15	569	14142-20	77	14305-04	81
12303B20	51	12550-55	459	12633-23	134	12930-52	103	14102F20	569	14145-10	77	14305-06	81
12303B24	51	12550-56	459	12633-26	134	12930-62	103	14103-02	76	14145-15	77	14362-02	81
12303G16	51	12550-58	458	12635-23	135	12930-63	103	14103-04	76	14145-20	77	14362-04	81
12303G20	51	12550-60	459	12635-26	135	12930-68	104	14103-06	76	14147-15	77	14362-06	81
12303G24	51	12550-62	458	12635-30	135	12930-69	104	14103-10	76	14147-20	77	14365-02	81
12303O16	51	12550-63	458	12635-35	135	12930-74	104	14103-15	76	14148-10	77	14365-04	81
12303O20	51	12550-64	458	12636-32	135	12930-77	104	14103-20	76	14148-15	77	14365-06	81
12303O24	51	12550-66	459	12640-14	124	12930-78	104	14103F02	569	14148-20	77	14402-00	83
12303W16	51	12550-68	458	12640-16	124	12931-51	104	14103F04	569	14151-10	78	14405-00	83
12303W20	51	12550-69	458	12640-18	124	12931-53	104	14103F06	569	14151-15	78	14407-00	83
12303W24	51	12550-70	458	12640-20	124	12940-02	130	14103F10	569	14151-20	78	14409-01	83

NUMERICAL INDEX INDICE NUMERICO NUMERISCH INDEX INDEX NUMERIQUE INDICE NUMERICO

Cod.	pag.	Cod.	pag.	Cod.	pag.	Cod.	pag.	Cod.	pag.	Cod.	pag.	Cod.	pag.
14409-02	83	14591-00	85	14722-22	90	15100-04	94	15661-20	25	16139-10	32	16948-40	57
14480-20	353	14592-00	85	14722-33	90	15100-07	94	15661-24	25	16140-01	33	16948-45	57
14502-00	80	14595-00	85	14722-99	90	15100-AA	94	15661-28	25	16140-02	33	16948-50	57
14502F00	569	14597-00	85	14725-00	90	15101-06	92	16101-16	54	16140-03	33	16948-60	57
14503-00	80	14598-00	85	14725-11	90	15101-10	92	16101-20	54	16140-04	33	16948-61	57
14503F00	569	14599-00	85	14725-22	90	15101-15	92	16101-24	54	16140-05	33	16961-16	55
14504-00	80	14661-20	86	14725-33	90	15101-20	92	16101-28	54	16302-02	82	16961-20	55
14504F00	569	14662-06	86	14725-99	90	15105-06	92	16101-32	54	16302-04	82	16961-24	55
14505-00	80	14662-10	86	14727-00	90	15105-10	92	16101-36	54	16302-06	82	16961-28	55
14505F00	569	14662-15	86	14727-11	90	15105-15	92	16101-40	54	16303-02	82	16961-32	55
14507-00	80	14662-20	86	14727-22	90	15105-20	92	16101-45	54	16303-04	82	16961-36	55
14507F00	569	14665-06	86	14727-33	90	15107-06	92	16101-50	54	16303-06	82	16961-40	55
14508-00	80	14665-10	86	14727-99	90	15107-10	92	16106-16	54	16305-02	82	16961-45	55
14508F00	569	14665-15	86	14728-00	90	15107-15	92	16106-20	54	16305-04	82	16961-50	55
14509-00	80	14665-20	86	14728-11	90	15107-20	92	16106-24	54	16305-06	82	16961-60	55
14509F00	569	14667-06	87	14728-22	90	15108-06	92	16106-28	54	16362-02	82	16965-40	57
14510-00	80	14667-10	87	14728-33	90	15108-10	92	16107-16	54	16362-04	82	16965-50	57
14510F00	569	14667-15	87	14728-99	90	15108-15	92	16107-20	54	16362-06	82	17610-01	130
14512-00	80	14667-20	87	14729-00	90	15108-20	92	16107-28	54	16363-02	82	17610-02	130
14515-00	80	14668-06	87	14729-11	90	15109-06	92	16107-32	54	16363-04	82	17610-05	130
14517-00	80	14668-10	87	14729-22	90	15109-10	92	16107-36	54	16363-06	82	17610-10	130
14518-00	80	14668-15	87	14729-33	90	15109-15	92	16107-40	54	16365-02	82	17621-01	379
14519-00	80	14668-20	87	14729-99	90	15109-20	92	16107-45	54	16365-04	82	17621-02	379
14522-00	80	14669-06	87	14730-00	90	15110-06	92	16107-50	54	16365-06	82	17621-09	379
14523-00	80	14669-10	87	14730-11	90	15110-10	92	16108-24	54	16712-22	57	17621-40	379
14525-00	80	14669-15	87	14730-22	90	15338-38	26	16108-28	54	16712-26	57	17621-44	379
14527-00	80	14669-20	87	14730-33	90	15339-36	26	16109-24	54	16712-30	57	17621-80	379
14528-00	80	14670-06	87	14730-99	90	15343-36	26	16109-28	54	16717-20	56	17621-90	379
14529-00	80	14670-10	87	14912-00	92	15403-16	26	16109-32	54	16717-24	56	17621-92	379
14532-00	80	14671-00	87	14915-00	92	15406-16	26	16109-36	54	16717-28	56	18000-16	161
14535-00	80	14672-00	87	14922-00	93	15406-20	26	16109-40	54	16717-32	56	18000-20	161
14537-00	80	14675-00	87	14922-11	93	15407-16	26	16109-45	54	16717-36	56	18000-23	161
14538-00	80	14677-00	87	14922-22	93	15407-20	26	16109-50	54	16717-40	56	18000-26	161
14539-00	80	14678-00	87	14922-33	93	15409-26	26	16113-20	56	16719-12	36	18000-26	177
14542-00	80	14679-00	87	14922-77	93	15409-30	26	16113-24	56	16910-14	57	18000-30	161
14543-00	80	14680-00	87	14922-99	93	15409-36	26	16113-28	56	16910-16	57	18000-30	177
14545-00	80	14682-00	87	14925-00	93	15415-03	26	16113-32	56	16910-18	57	18000-36	161
14547-00	80	14685-00	87	14925-11	93	15428-06	399	16113-36	56	16910-20	57	18000B16	161
14548-00	80	14687-00	87	14925-22	93	15430-11	26	16113-40	56	16924-20	132	18000B20	161
14549-00	80	14688-00	87	14925-33	93	15438-50	26	16114-20	54	16924-24	132	18000B23	161
14552-00	81	14689-00	87	14925-77	93	15606-09	29	16114-24	54	16924-28	132	18000B26	161
14555-00	81	14690-00	87	14925-99	93	15606-10	29	16114-28	54	16927-32	131	18000B30	161
14561-15	84	14691-00	87	14927-00	93	15606-12	29	16114-32	54	16927-36	131	18000G16	161
14561-20	84	14692-00	87	14927-11	93	15606-16	25	16114-36	54	16927-40	131	18000G20	161
14562-06	84	14695-00	87	14927-22	93	15606-20	25	16114-40	54	16927-45	131	18000G23	161
14562-10	84	14702-06	89	14927-33	93	15606-24	25	16115-36	54	16927-50	131	18000G26	161
14562-15	84	14702-10	89	14927-77	93	15606-28	25	16115-40	54	16929-36	54	18000G30	161
14562-20	84	14702-15	89	14927-99	93	15607-10	29	16115-45	54	16929-40	54	18000M16	161
14565-06	84	14702-20	89	14928-00	93	15607-16	25	16116-28	56	16938-36	54	18000M20	161
14565-10	84	14705-06	89	14928-11	93	15607-20	25	16116-32	56	16938-40	54	18000M23	161
14565-15	84	14705-10	89	14928-22	93	15607-24	25	16116-36	56	16938-45	54	18000M26	161
14565-20	84	14705-15	89	14928-33	93	15607-28	25	16116-40	56	16939-50	57	18000R16	161
14567-06	85	14705-20	89	14928-77	93	15608-20	25	16117-20	56	16939-60	57	18000R20	161
14567-10	85	14707-06	89	14928-99	93	15608-24	25	16117-24	56	16939-70	57	18000R23	161
14567-15	85	14707-10	89	14929-00	93	15608-28	25	16117-28	56	16939-80	57	18000R26	161
14567-20	85	14707-15	89	14929-11	93	15609-20	25	16117-32	56	16940-28	226	18000R30	161
14568-06	85	14707-20	89	14929-22	93	15609-24	25	16117-36	56	16940-32	226	18000W20	161
14568-10	85	14708-06	89	14929-33	93	15609-28	25	16117-40	56	16940-36	226	18000W26	161
14568-15	85	14708-10	89	14929-77	93	15611-12	29	16118-24	56	16940-40	226	18000W30	161
14568-20	85	14708-15	89	14929-99	93	15614-12	29	16120-24	55	16941-40	57	18000Y16	161
14569-06	85	14708-20	89	14930-00	93	15614-20	25	16120-28	55	16941-45	57	18000Y20	161
14569-10	85	14709-06	89	14930-11	93	15614-24	25	16120-32	55	16941-50	57	18000Y23	161
14569-15	85	14709-10	89	14930-22	93	15614-28	25	16120-36	55	16941-61	57	18000Y26	161
14569-20	85	14709-15	89	14930-33	93	15614-32	25	16120-40	55	16943-40	57	18002-18	162
14570-06	85	14709-20	89	14930-77	93	15615-12	29	16127-16	55	16943-45	57	18002-18	177
14570-10	85	14710-06	89	14930-99	93	15615-16	29	16127-20	55	16943-50	57	18002-20	162
14571-00	85	14710-10	89	14942-99	92	15615-20	25	16127-32	55	16943-60	57	18002-22	162
14572-00	85	14712-00	89	14945-99	92	15615-24	25	16127-36	55	16943-61	57	18002-26	162
14575-00	85	14715-00	89	14947-99	92	15615-28	25	16127-40	55	16944-45	57	18002-26	177
14577-00	85	14717-00	89	14958-01	345	15615-32	25	16134-12	32	16944-50	57	18002-30	162
14578-00	85	14718-00	89	14958-02	345	15638-17	29	16135-12	32	16944-60	57	18002-36	162
14579-00	85	14719-00	89	15100-01	94	15643-12	29	16136-10	32	16947-50	57	18002B26	162
14580-00	85	14722-00	90	15100-02	94	15661-10	29	16137-10	32	16947-60	57	18002R18	162
14585-00	85	14722-11	90	15100-03	94	15661-12	29	16138-10	32	16947-61	57	18002R20	162

Cod.	pag.	Cod.	pag.	Cod.	pag.	Cod.	pag.	Cod.	pag.	Cod.	pag.	Cod.	pag.
18002R22	162	18015-27	165	18028W36	168	18132-KA	509	18166-KE	510	18221G21	169	18323-00	294
18002R26	162	18015B18	165	18028Y25	168	18132-KE	510	18166-KP	510	18221M17	169	18324-00	294
18002R30	162	18015B22	165	18028Y30	168	18132-KP	573	18166-KU	510	18221M19	169	18324-10	107
18002R36	162	18015R22	165	18029-25	167	18132-KQ	573	18166U24	504	18221M21	169	18324-10	294
18002Y18	162	18015Y18	165	18029-30	167	18132-KU	510	18166U36	504	18221R17	170	18324F10	570
18002Y26	162	18015Y27	165	18029-36	167	18132U54	504	18166U40	504	18221R19	170	18325-01	215
18002Y30	162	18016-14	165	18029W30	167	18132U55	505	18168A24	504	18221R21	170	18325-02	215
18002Y36	162	18016-16	165	18029W36	167	18136A33	505	18168E24	504	18221Y17	170	18325-03	215
18005-22	161	18016-16	177	18030-26	168	18136A34	505	18168-GA	508	18221Y19	170	18341-KE	510
18005-27	161	18016B14	165	18030-31	168	18136A40	505	18168U24	504	18221Y21	170	18341-KU	510
18005-32	161	18016B16	165	18030-36	168	18136A41	505	18172-54	502	18222-18	171	18353-17	499
18005B22	162	18016R14	165	18030W26	168	18136E33	505	18172A54	504	18224-28	170	18353-AA	574
18005B27	162	18016R16	165	18030W31	168	18136E34	505	18172A55	503	18224B28	170	18353-BB	574
18005B32	162	18016W16	165	18030W36	168	18136E40	505	18172-AF	574	18224R28	170	18353-CA	574
18005G22	162	18016Y14	166	18099-15	177	18136E41	505	18172-AG	574	18224Y28	170	18353-DB	574
18005G27	162	18016Y16	166	18100-16	158	18136-EA	509	18172E54	504	18225-28	170	18353-VA	574
18005G32	162	18017-14	166	18100-20	158	18136-EB	509	18172E55	503	18225R28	170	18501-01	301
18005R22	162	18017-16	166	18100-20	178	18136-KA	509	18172U54	504	18226-17	172	18501-02	301
18005R27	162	18017-18	166	18100-24	158	18136-KE	510	18172U55	503	18226B17	172	18501-03	301
18005R32	162	18017B16	166	18100-24	177	18136-KP	573	18176-30	502	18226G17	172	18501-04	301
18005Y22	162	18017R16	166	18100-30	158	18136-KQ	573	18176-36	502	18226R17	172	18501-05	301
18005Y27	162	18017Y16	166	18100-30	177	18136-KR	573	18176-40	502	18226W17	172	18502-18	301
18005Y32	162	18018-11	166	18100-36	158	18136-KU	510	18176A30	503	18226Y17	172	18503-12	301
18006-20	163	18018R11	166	18102-16	158	18136U33	505	18176A36	503	18230-13	159	18504-15	301
18006-25	163	18018Y11	166	18102-16	178	18136U34	505	18176A40	503	18230-17	159	18509-01	119
18006-30	163	18019-12	166	18102-20	158	18136U40	505	18176-AE	574	18230-17	177	18509-02	119
18006-36	163	18019-14	166	18102-26	158	18136U41	505	18176-AF	574	18231-13	159	18509-03	119
18006B20	163	18019-16	166	18102-30	158	18162-54	502	18176-AH	574	18235-26	172	18510-07	119
18006B25	163	18019-18	166	18103-18	158	18162A54	504	18176E30	503	18235-26	178	18510F07	570
18006B30	163	18019-20	166	18104-18	158	18162A55	503	18176E36	503	18235-30	172	18511-15	118
18006G20	163	18019R12	166	18106-15	158	18162-AA	508	18176E40	503	18235-30	177	18511F15	570
18006G25	163	18019R16	166	18106-20	158	18162-AF	573	18176I30	502	18235B30	172	18512-15	118
18006R25	163	18019R20	166	18106-20	178	18162-AG	573	18176I36	502	18235G30	172	18513-14	119
18006R30	163	18020-23	166	18106-25	158	18162E54	504	18176I40	502	18235R30	172	18513F14	570
18006Y20	163	18020B23	166	18106-25	178	18162E55	503	18176U36	503	18235W30	172	18514-17	119
18006Y25	163	18020R23	166	18106-30	158	18162-KE	510	18176U40	503	18235Y30	172	18514-18	119
18006Y30	163	18021-18	166	18109-26	158	18162-KU	510	18190-09	178	18236-30	172	18514-18	171
18007-25	163	18021B18	166	18109-26	178	18162-RA	508	18190-AA	574	18237-26	172	18515-16	118
18007-30	163	18021R18	166	18109-30	158	18162-RB	561	18192-09	178	18251-01	172	18516-24	119
18007-36	163	18022-12	166	18110-26	158	18162-RB	508	18199-19	177	18251-02	173	18517-24	119
18007G30	163	18023-11	166	18110-30	158	18162U54	504	18201-36	171	18255-00	177	18518-22	119
18008-20	163	18024-08	167	18110-36	158	18162U55	503	18203-26	171	18255-00	177	18518-26	119
18008-26	163	18024-11	167	18111-30	158	18166-24	502	18205-10	171	18261-00	173	18518-30	119
18008-30	163	18024-11	177	18112-30	158	18166-30	502	18205-12	171	18263-00	173	18519-15	119
18008-36	163	18024B08	167	18112-30	177	18166-36	502	18206-09	171	18270-22	173	18519-22	119
18008B30	163	18024B11	167	18114-20	158	18166-40	502	18207-15	171	18271-00	174	18519-26	119
18008R26	163	18024G08	167	18115-20	159	18166A24	503	18209-06	171	18271-00	178	18519-26	177
18008R30	163	18024G11	167	18115-20	177	18166A30	503	18215-13	171	18272-00	174	18519-30	119
18008R36	163	18024M08	167	18115-25	159	18166A36	503	18215-21	171	18273-00	174	18519-35	119
18008Y30	164	18024M11	167	18116-14	159	18166A40	503	18217-12	167	18274-00	174	18520-04	119
18009-25	164	18024R08	167	18116-14	177	18166-AA	508	18220-18	170	18275-00	173	18520-06	119
18009-30	164	18024R11	167	18116-18	159	18166-AB	508	18220-20	170	18276-00	174	18520-08	119
18009-30	177	18024W08	167	18122-12	159	18166-AC	508	18220-22	170	18276-00	177	18520-10	119
18009-36	164	18024W11	167	18123-11	159	18166-AD	574	18220-26	170	18276-00	294	18520-12	119
18009B25	164	18024Y08	167	18124-09	159	18166-AE	574	18220B18	170	18277-00	140	18520-15	301
18009R25	164	18026-07	167	18124-09	178	18166-AF	574	18220B20	170	18278-00	173	19701-00	150
18009W25	164	18026-07	177	18125-07	159	18166-AH	574	18220B22	170	18279-14	173	19702-00	149
18009W30	164	18026B07	167	18125-10	159	18166-AM	508	18220B26	170	18280-10	176	19705-00	149
18009Y25	164	18026G07	167	18125-10	177	18166E24	504	18220R18	170	18280-16	176	19706-00	149
18009Y30	164	18026M07	167	18126-07	159	18166E30	504	18220R20	170	18280-22	176	19709-00	149
18010-25	164	18028-21	168	18126-07	177	18166E36	504	18220R22	170	18281-24	176	19810-00	147
18010-30	164	18028-25	168	18128-20	159	18166E40	504	18220R26	170	18282-18	176	19810-AA	574
18010-36	164	18028-30	168	18128-20	178	18166-EB	509	18220Y18	170	18282-19	176	19810-AB	574
18010Y30	164	18028-30	177	18128-24	159	18166-EC	509	18220Y20	170	18282-22	176	19901-35	514
18011-32	164	18028-36	168	18128-24	178	18166-ED	509	18220Y22	170	18283-27	176	19901-40	514
18012-32	164	18028B30	168	18128-30	159	18166-EG	509	18220Y26	170	18283-33	176	19901-47	514
18012B32	164	18028F21	570	18128-30	177	18166-EH	509	18221-17	169	18284-21	176	19902-38	514
18013-30	164	18028F25	570	18132A54	504	18166-EI	509	18221-19	169	18284-27	176	32936-05	405
18013-36	164	18028F30	570	18132A55	505	18166-EJ	509	18221-21	169	18284-30	176	41200-01	375
18013G36	165	18028F36	570	18132-AE	510	18166-EL	509	18221B17	169	18284-33	176	41200-02	375
18013W30	165	18028M25	168	18132-AU	510	18166-EM	509	18221B19	169	18301-01	294	41200-03	375
18013W36	165	18028W21	168	18132E54	504	18166I30	502	18221B21	169	18301-02	295	41200-04	375
18015-18	165	18028W25	168	18132E55	505	18166I36	502	18221G17	169	18302-01	295	41200-05	375
18015-22	165	18028W30	168	18132-FB	509	18166I40	502	18221G19	169	18302-02	295	41200-06	375

NUMERICAL INDEX INDICE NUMERICO NUMERISCH INDEX INDEX NUMERIQUE INDICE NUMERICO

Cod.	pag.	Cod.	pag.	Cod.	pag.	Cod.	pag.	Cod.	pag.	Cod.	pag.	Cod.	pag.
41200-07	375	41209-04	491	41414-31	310	41458-50	325	41472-36	322	41491C03	334	41507B03	403
41200-08	375	41209-05	491	41414-36	310	41458-51	325	41472-37	323	41491C04	334	41507B04	403
41200-09	375	41209-06	491	41415-11	492	41459-10	324	41472-38	323	41491C05	334	41507C03	403
41200-10	375	41210-01	34	41415-11	482	41460-05	324	41472-41	323	41491C06	335	41507C04	403
41200-11	375	41210-03	34	41416-18	313	41460-10	324	41472-42	323	41491G00	334	41508C12	404
41200-13	375	41210-05	34	41416-18	395	41461-07	339	41472-43	316	41491G01	334	41509B20	404
41200-14	375	41210-07	34	41416-20	312	41461A07	338	41472-44	317	41491G02	334	41510-08	405
41200-15	375	41210-08	34	41416-24	312	41461B07	339	41472-45	317	41491G03	334	41511-00	405
41200-16	375	41210-10	34	41416-25	312	41461C07	339	41472-46	317	41491G04	334	41511-20	405
41200-17	375	41210-12	34	41416-28	312	41461-C4	362	41472-47	323	41491G05	334	41511-30	405
41200-18	376	41210-13	34	41416-32	312	41461-C5	363	41472-48	323	41491G06	335	41512-50	347
41200-32	376	41210-14	34	41418-11	482	41461-C6	363	41472-50	323	41492-00	358	41513-13	347
41200-33	376	41220-01	484	41418-12	482	41461G07	339	41473-31	316	41492B00	358	41513A20	348
41200-34	376	41220-02	484	41418B11	485	41461-G4	362	41473-39	316	41492C00	358	41513B20	348
41200-36	376	41220-03	484	41418B12	485	41461-G5	363	41473-44	316	41492G00	358	41513C20	348
41200-40	376	41220-04	484	41419-12	482	41461-G6	363	41473-50	316	41493A00	327	41513G20	348
41200-41	376	41220-05	485	41420-24	469	41463-01	329	41473-56	316	41493B00	328	41514-05	340
41200-46	376	41220-06	485	41420-30	311	41463-02	329	41473-62	316	41493C00	328	41514-10	340
41200-47	376	41220-07	485	41420-31	312	41463A00	330	41473-66	316	41493-C2	361	41514-C5	362
41200-48	376	41220-11	485	41422-25	313	41463A05	329	41474-00	316	41493G00	328	41514-G5	362
41200-49	376	41220-12	485	41422-27	312	41463A30	330	41474-02	316	41493-G2	361	41515-03	346
41200-50	376	41220-24	485	41422-30	313	41463A50	330	41475-00	315	41494A00	327	41515-05	346
41200-51	376	41311-AA	398	41422-38	312	41463B05	329	41475-01	315	41494B00	328	41515-06	346
41200-52	376	41311-AA	575	41422-42	312	41463C00	330	41475-03	315	41494C00	328	41515-07	346
41200-53	376	41312-00	398	41425-AA	494	41463C30	330	41475-04	315	41494-C2	361	41515-08	346
41200-54	376	41313-00	399	41430-11	477	41463C50	330	41475-05	315	41494-C3	361	41515-09	346
41200-55	376	41314-00	399	41431-08	315	41463G05	329	41475-20	315	41494G00	328	41515-10	346
41200-56	376	41315-02	399	41431-12	315	41463M05	329	41476-50	316	41494-G2	361	41515-18	347
41200-57	376	41317-20	399	41436-11	476	41464-09	339	41477-50	340	41494-G3	361	41515-19	346
41200-58	376	41318-00	398	41436-12	476	41464A09	338	41478-35	340	41495-08	334	41515-20	347
41200-59	376	41320-25	369	41442-03	495	41464B09	339	41478-50	340	41495-10	334	41515-21	347
41200-60	376	41321-40	369	41443-AE	575	41464C09	339	41479-05	340	41496-40	405	41515-22	346
41200-61	376	41321-44	369	41445-01	469	41464G09	339	41479-11	340	41497-05	331	41516-20	402
41200-62	376	41322-19	369	41445-02	469	41465-10	345	41479-AA	340	41497A05	327	41516C20	402
41200-63	376	41322-25	369	41445-05	469	41467A08	338	41480-03	339	41497B05	331	41516G20	402
41200-64	376	41322-31	369	41445-06	469	41467B08	339	41480-05	339	41497C05	331	41518-00	401
41202-01	304	41325-20	369	41445-07	469	41467C08	339	41480-07	339	41497G05	331	41518-01	401
41202-02	304	41325-30	369	41445-09	469	41467-C5	362	41480A05	338	41498A00	327	41518-02	401
41203-01	304	41325-40	369	41445-11	311	41467G08	339	41480B05	339	41498B00	328	41518A12	347
41203-11	304	41326-26	369	41445-22	468	41467-G5	362	41480C05	339	41498C00	328	41518B12	347
41204-01	373	41326-30	370	41445-26	468	41468-20	315	41480-C8	363	41498G00	328	41518C12	347
41204-02	373	41326-33	370	41445-30	468	41468-24	315	41480G05	339	41499-08	405	41518G12	347
41204-03	373	41326-36	370	41446-18	468	41469-20	315	41480-G8	363	41499B00	328	41520-08	130
41204-04	374	41326-40	370	41446-23	468	41469-24	315	41481-02	340	41499C00	328	41520-12	130
41204-05	374	41326-42	370	41447-02	492	41470A00	331	41481-03	340	41499G00	328	41520-16	130
41204-06	374	41326-43	370	41447-05	492	41470A03	331	41483-04	340	41500-00	357	41520-24	130
41204-07	374	41327-01	368	41447-38	465	41470C00	331	41484-05	339	41500-AA	357	41521-01	366
41204-08	374	41327-02	368	41448-06	495	41470C03	331	41484A05	338	41501-20	403	41521-02	366
41204-09	374	41327-03	368	41448-10	495	41471-00	315	41484B05	339	41501-23	403	41522-14	364
41204-10	374	41327-04	368	41448-25	495	41471-12	315	41484C05	339	41501-40	403	41523-08	364
41204-11	374	41327-05	368	41448-40	495	41471-15	315	41484-C3	361	41502-20	402	41523-09	364
41204-12	374	41327-06	369	41450-AA	324	41471-17	315	41484G05	339	41503-00	345	41523G08	365
41205-01	366	41327-07	369	41451-05	324	41472-01	317	41484-G3	361	41503-21	345	41523G09	365
41205-02	366	41327-08	369	41451-10	324	41472-04	316	41486-00	315	41503-22	345	41524-04	364
41205-03	366	41327-09	369	41452N10	305	41472-07	316	41486-01	315	41503C21	345	41524-09	364
41205-04	366	41327-10	369	41452N16	305	41472-08	316	41486-08	315	41503G21	345	41524-10	365
41205-05	366	41380-01	155	41453-11	344	41472-12	307	41486-12	315	41504-09	404	41524-11	365
41205-06	366	41380-02	155	41453-AA	345	41472-13	307	41486-15	315	41504-10	404	41524-12	365
41205-07	366	41390-00	407	41454-01	345	41472-14	319	41487-12	315	41504-11	404	41524C10	365
41205-08	366	41391-08	407	41454-99	345	41472-15	319	41487-15	315	41504-19	404	41524C11	365
41205-09	366	41394-02	406	41455-BC	324	41472-16	318	41487-17	315	41504B19	404	41524C12	365
41205-10	367	41400-AA	494	41455-CA	325	41472-17	318	41489-20	315	41504G20	404	41525-00	306
41206-01	369	41400-AB	575	41455-CB	325	41472-18	318	41490-00	333	41504W20	404	41525-01	306
41206-02	369	41402-AA	575	41455T55	324	41472-19	319	41490-01	333	41505-00	403	41526-01	129
41206-03	309	41403-01	96	41456-02	344	41472-20	318	41490-AA	333	41505-17	403	41526-02	129
41206-04	367	41403-02	96	41457-00	345	41472-21	318	41490B00	333	41505-19	403	41526-05	129
41206-05	498	41403-03	96	41458-02	324	41472-22	318	41490B01	333	41505-20	403	41526-06	129
41207-02	370	41403-04	96	41458-05	324	41472-23	319	41490C00	333	41505B15	404	41526-B1	129
41207-03	370	41405-AA	494	41458-10	324	41472-24	319	41490C01	333	41506-11	474	41526-B2	129
41208-02	309	41405-AB	575	41458-11	325	41472-25	307	41490G00	333	41506-19	487	41526-B3	129
41208-06	309	41412-11	492	41458-21	325	41472-32	313	41490G01	333	41506B11	474	41526-G1	129
41209-01	491	41413-30	310	41458-23	324	41472-33	322	41491C00	334	41506B19	487	41526-G2	129
41209-02	491	41414-21	310	41458-24	324	41472-34	322	41491C01	334	41506C11	474	41526-G3	129
41209-03	491	41414-30	309	41458-25	325	41472-35	322	41491C02	334	41506C19	487	41526-R1	129

Cod.	pag.	Cod.	pag.	Cod.	pag.	Cod.	pag.	Cod.	pag.	Cod.	pag.	Cod.	pag.
41526-R2	129	41589-07	387	41605-30	335	41651-40	476	41707-45	59	41752-12	301	41807-12	499
41526-R3	129	41589-08	386	41605A03	335	41651-45	476	41707-50	59	41752-24	301	41808-04	500
41527-10	364	41589-14	386	41605A27	335	41651-50	476	41708-32	59	41753D30	210	41808B07	500
41527-11	364	41589-16	386	41605A30	335	41651-55	476	41708-36	59	41753D32	210	41808B90	500
41527-12	364	41589-20	386	41605B03	336	41651-60	476	41708-40	59	41753D53	210	41809-09	509
41527-13	364	41589-22	387	41605B27	335	41651-65	476	41708-45	59	41753D60	210	41810-04	498
41527G10	365	41589-25	387	41605B30	335	41654-80	476	41708-50	59	41755-11	300	41810-09	498
41527G11	365	41589-29	387	41605C03	336	41654-99	476	41717-60	59	41756-30	209	41810B04	498
41527G12	365	41589-30	387	41605C30	335	41659-06	226	41719-36	58	41756-32	209	41860-36	359
41527G13	365	41589-31	387	41605G03	335	41659-07	226	41719-40	58	41756-53	209	41860-43	359
41528-21	129	41589-34	387	41605G27	335	41659-08	226	41720-18	56	41756-60	209	41860-47	359
41528-22	129	41589-35	387	41605G30	335	41660-10	224	41720-20	56	41758-53	274	41861-44	359
41529-05	391	41589-37	387	41606-00	344	41660-15	224	41720-24	56	41758-60	274	41862B11	359
41530-05	391	41589-50	388	41606-01	344	41670-06	123	41720-28	56	41758-65	274	41862B53	359
41530-07	391	41589-58	387	41606-02	344	41670-09	123	41720-30	56	41758-85	274	41862C11	359
41530-11	391	41589-59	387	41606-22	344	41670-AA	123	41720-32	56	41759-01	273	41862C53	359
41532B15	365	41589-99	388	41607-00	306	41670-AB	123	41727-28	298	41759-01	273	41862G11	359
41532B23	365	41589-AA	388	41608-03	357	41671-11	123	41727-30	298	41759-04	274	41862G53	359
41532C15	365	41589-AB	388	41608-04	357	41672-00	123	41727-33	298	41759-05	273	41863-35	359
41532C23	365	41589-AC	388	41608-20	357	41673-00	123	41727-36	298	41759-07	274	41864-56	359
41532G15	365	41589-BB	388	41608C04	357	41674-00	123	41727-40	298	41759-08	274	41865-40	359
41532G23	365	41589C08	388	41608G04	357	41675-00	123	41727-45	298	41759-09	273	41870-01	472
41537-00	307	41589C16	388	41609-36	337	41676-00	123	41727-50	298	41760-02	274	41870-02	472
41537-03	307	41589-CC	388	41609-75	337	41677-00	123	41727-55	298	41760-05	274	41870-03	472
41537-06	307	41590-01	497	41609A36	337	41678-00	123	41727-60	298	41760-06	274	41870-04	472
41537-08	307	41590-02	497	41609B36	337	41678-14	405	41729-30	229	41760-08	274	41875-40	478
41538-30	309	41590-04	497	41609C36	337	41679-23	398	41729-34	229	41760-09	274	41875-61	478
41541-44	474	41590-06	497	41609G36	337	41680-03	349	41734-60	298	41760-20	273	41876-30	478
41558-00	402	41591-10	497	41611-20	343	41680-06	349	41735-20	292	41760-21	273	41876-38	478
41559-04	401	41591-15	497	41614-22	307	41680-12	349	41735-29	291	41760-22	272	41876-45	478
41560-28	398	41591-32	401	41614-33	307	41681-01	350	41736-32	291	41760-26	272	41876-58	478
41561-09	392	41591-36	401	41614-34	307	41681-02	350	41737-17	292	41760-27	272	41877-45	478
41562-18	401	41591-40	401	41614-35	307	41681-03	350	41737-20	292	41761-02	293	41877-61	478
41563-07	392	41591-45	401	41614-36	307	41681-04	350	41737-23	292	41762-07	302	41877-81	478
41563-AA	575	41591-90	401	41615-01	392	41681-06	350	41737G20	293	41762-09	302	41877-99	478
41564-07	392	41592-36	401	41615-03	392	41681-10	349	41737G23	293	41762-13	302	41878-45	478
41564-AA	575	41592-45	401	41615-05	392	41681-11	349	41738-17	292	41763-00	302	41878-61	478
41569-34	399	41593-20	401	41617-05	308	41681-12	349	41738-20	292	41763-30	525	41878-81	478
41570-10	135	41594-12	401	41617-15	308	41681-13	349	41738-23	292	41764-33	292	41878-99	478
41570A10	336	41594-18	400	41618-14	308	41681-99	350	41739-20	292	41765-32	291	41879-30	478
41570B10	336	41595-20	336	41628-15	405	41683-26	127	41743D32	210	41765-37	291	41879-40	478
41570C10	336	41595B44	136	41629-17	392	41686-12	401	41743D53	210	41765-41	291	41879-50	478
41570G10	336	41595B45	136	41629-20	392	41687-06	401	41743D60	210	41765-45	291	41879-61	478
41582-00	181	41597-04	391	41629-25	392	41687-12	401	41744-32	209	41765-50	291	41880-38	478
41583-00	182	41598-00	391	41635-02	396	41690A11	505	41744-53	209	41766-14	292	41880-61	478
41585-00	382	41599-08	391	41638-01	396	41690E11	505	41744-60	209	41766-16	292	41881-30	478
41585-01	382	41600-00	336	41638-02	396	41690U11	505	41745-30	300	41766-27	292	41881-40	478
41585-02	382	41600C00	336	41638-04	396	41691A11	505	41745-35	300	41767-20	292	41882-15	478
41585-03	382	41600G00	336	41638-12	396	41691E11	505	41745-40	300	41767-AA	576	41882-20	478
41585-10	382	41601-17	308	41638-13	396	41691U11	505	41745-50	300	41767G20	293	41882-25	478
41585-11	381	41602-00	308	41638-91	575	41695-10	510	41745-60	300	41768-21	292	41882-30	478
41585-12	381	41603-00	337	41638-92	575	41695-15	510	41745-65	300	41768-22	292	41885-40	478
41585-13	381	41603-07	337	41638-93	575	41695-50	510	41746-60	209	41769-00	293	41885-45	478
41585-23	381	41603A00	337	41638-94	575	41697-00	125	41747-60	209	41769-01	293	41885-50	478
41585-24	381	41603A07	337	41638-95	575	41698-22	125	41748-20	210	41769-02	293	41885-60	478
41585-25	381	41603B00	337	41639-11	397	41698-30	125	41748-30	210	41769-36	292	41900-04	500
41585-30	381	41603B07	337	41639-17	397	41698-40	125	41748-35	210	41769-50	292	41900-10	500
41585-37	381	41603C00	337	41639-30	397	41699-03	358	41748-40	210	41769G00	293	41901-08	499
41585-45	382	41603C07	337	41639-31	397	41699-04	358	41748-50	210	41770-15	299	41901-16	499
41585-51	382	41603G00	337	41639-40	397	41699-06	357	41750-20	210	41771-96	299	41903A10	506
41585-52	382	41603G07	337	41639-41	397	41699-10	357	41750-30	210	41773-00	126	41903E10	506
41585-53	382	41604-00	337	41639-42	397	41699-12	358	41750-40	210	41774-33	295	41903U10	506
41585-54	382	41604-01	338	41645-00	306	41699-13	358	41750-41	210	41775-34	295	41904-10	500
41586-22	382	41604A00	337	41646-06	389	41699-18	358	41750-50	210	41780-05	288	41905-38	491
41586-28	382	41604A01	337	41646-10	389	41699-20	357	41751-30	209	41780-07	288	41909-08	498
41586-33	382	41604B00	337	41646-15	389	41699B18	358	41751-35	209	41780-09	288	41910-AL	576
41586-38	382	41604B01	338	41646-20	389	41699C18	358	41751-40	209	41782-04	352	41911-02	497
41587-03	382	41604C00	337	41650-06	388	41699G18	358	41751-50	209	41782-05	352	41911-03	497
41587-25	382	41604C01	338	41650-10	388	41703-38	59	41751-60	209	41782-06	352	41911-04	497
41587-32	382	41604G00	337	41650-13	388	41704G33	293	41751-65	209	41800-05	499	41912-03	495
41589-00	388	41604G01	338	41651-20	476	41704G36	293	41751F30	571	41800-10	499	41912-04	496
41589-01	388	41605-00	335	41651-25	476	41707-32	59	41751F40	571	41801-05	499	41913-03	496
41589-02	388	41605-01	335	41651-30	476	41707-36	59	41751F60	571	41806-00	498	41913-04	496
41589-04	388	41605-03	335	41651-35	476	41707-40	59	41752-08	301	41806-03	498	41914-03	71

NUMERICAL INDEX INDICE NUMERICO NUMERISCH INDEX INDEX NUMERIQUE INDICE NUMERICO

Cod.	pag.	Cod.	pag.	Cod.	pag.	Cod.	pag.	Cod.	pag.	Cod.	pag.	Cod.	pag.
41916-10	134	42452-53	482	42512-35	127	42538-05	183	42574-91	577	42620P05	428	42655P15	427
41916-15	134	42453-23	494	42512-90	534	42538-07	183	42574-92	577	42620P06	428	42655S15	427
41916-20	134	42460-00	492	42512-91	533	42538-09	183	42574-93	577	42621P03	432	42660-02	436
41922-16	134	42460-06	493	42512-92	533	42538F09	571	42574-94	577	42621P11	432	42661-03	428
41922-22	134	42460-27	494	42512-93	533	42539-00	183	42574-99	577	42622-02	437	42661-06	428
41925-14	135	42460-40	490	42513-30	127	42539-01	183	42575-37	147	42622P15	437	42662C14	431
41925-16	135	42460-43	498	42513-45	127	42539-02	183	42575-90	577	42622S15	437	42662P14	431
41925-18	135	42460-45	499	42514-20	179	42539-03	183	42575-91	577	42623-10	123	42662S14	431
41925-20	135	42460-53	470	42515-18	179	42539-04	183	42575-92	577	42624P10	421	42663C14	431
41925-22	135	42460-63	493	42515-20	179	42539-05	183	42575-93	577	42624S10	421	42663P14	431
41925-24	135	42460-64	493	42516-18	179	42539-07	183	42575-94	577	42625P12	427	42663S14	431
41925-26	135	42460-74	500	42516-20	179	42539-09	183	42575-99	577	42625P18	427	42664P12	414
41929-00	124	42460-76	500	42517-06	179	42539F09	571	42576-00	146	42625S12	427	42664P18	414
41929-02	124	42461-11	482	42518-01	183	42540-40	184	42577-39	146	42625S18	427	42664P22	414
41930-39	70	42461-35	482	42518-50	184	42540-50	184	42577-90	577	42626P12	427	42664P30	414
41931-08	135	42461B35	482	42519-01	185	42540-80	184	42577-91	577	42626P18	427	42664P40	414
41931-14	135	42463-02	490	42520-00	185	42541-06	184	42577-92	577	42626S12	427	42664S12	414
41931-16	135	42463A00	470	42520-AA	576	42542-00	185	42577-93	577	42626S18	427	42664S18	414
41931-18	135	42463A02	489	42521-16	183	42543-00	184	42577-94	577	42627P10	419	42664S22	414
41932-05	135	42463A04	489	42521-24	183	42543-01	184	42577-99	577	42627P12	419	42664S30	414
41933-18	135	42463A05	489	42522-00	183	42543-02	184	42579-00	181	42627P18	419	42665P12	414
41945-38	482	42463A08	489	42522-01	183	42543-03	184	42581-01	128	42627P22	419	42665P18	414
41960-08	132	42463A12	489	42522-02	183	42543-04	184	42581-03	128	42627P30	419	42665P22	414
41960-10	132	42463A15	489	42522-03	183	42543-05	184	42581-05	128	42627P40	419	42665P30	414
41960-12	132	42463B00	470	42522-04	183	42544-00	184	42581-10	128	42627S10	419	42665P40	414
41960-15	132	42463B02	490	42522-05	183	42544-01	184	42581-15	128	42627S12	419	42665S12	414
41961-10	132	42463B04	490	42522-07	183	42544-02	184	42581-20	128	42627S18	419	42665S18	414
41961-12	132	42463B05	490	42522-09	183	42544-03	184	42584-01	397	42627S22	419	42665S22	414
41961-15	132	42463B08	490	42522F09	571	42544-04	184	42584-02	397	42627S30	419	42665S30	414
41962-10	133	42463B12	490	42523-00	177	42544-05	184	42584-04	397	42628P10	419	42665S40	414
41962-12	133	42463B15	490	42524-06	180	42546-00	183	42584-05	397	42628P12	419	42666P12	414
41962-15	133	42464-02	486	42524-08	180	42546-01	183	42584-06	397	42628P18	419	42666P18	414
41964-45	70	42464-03	486	42524-10	180	42546-02	183	42584-07	397	42628P22	419	42666P22	414
41964-60	70	42470-00	492	42524-12	180	42546-03	183	42584B05	397	42628P30	419	42666P27	414
41980-99	126	42470-06	493	42524-14	180	42546-04	183	42584M01	397	42628P40	419	42666P30	414
42400-19	500	42470-27	494	42524-16	180	42546-05	183	42584M02	397	42628S10	419	42666P40	414
42400-25	500	42470-43	498	42524-18	180	42555-11	288	42584M04	397	42628S12	419	42666S12	414
42400-30	500	42470-45	499	42524-20	180	42556-00	145	42585-00	518	42628S18	419	42666S18	414
42401-10	389	42470-53	470	42524-22	180	42558-00	146	42585-04	518	42628S22	419	42666S22	414
42401-15	389	42470-63	493	42524-30	180	42560-01	144	42585-06	518	42628S30	419	42666S27	414
42401-20	389	42470-64	493	42525-27	180	42560-02	144	42586-09	518	42629-09	434	42666S30	414
42401-AA	576	42470-74	500	42526-12	180	42560-03	144	42586-10	518	42630P01	425	42666S40	414
42403-01	389	42470-76	500	42526-14	180	42560-04	144	42588-00	138	42630P02	425	42667P12	414
42403B01	389	42501-15	181	42528-00	184	42560-05	144	42588-01	138	42630P03	425	42667P18	414
42405-10	389	42501-20	181	42529-06	179	42560-06	144	42589-00	139	42630P04	425	42667P22	414
42405-20	389	42502-11	181	42530-26	181	42560-07	145	42592-02	125	42630P05	425	42667P30	414
42405-AA	576	42503-10	181	42530-32	181	42560-08	145	42593-00	398	42630P06	425	42667S12	414
42406-35	500	42504-09	127	42530-41	181	42560-09	145	42595-01	138	42630P07	425	42667S18	414
42406-40	500	42505-21	180	42530-50	181	42562-12	128	42596-02	138	42630P08	426	42667S22	414
42407-03	389	42505-24	180	42531-26	181	42562-14	128	42597-00	138	42630P09	426	42667S30	414
42407-06	389	42505-27	180	42531-32	181	42562-16	128	42598-00	139	42630P10	426	42669C14	431
42408-03	389	42505-50	180	42531-41	181	42562-18	128	42599-06	140	42630P11	426	42669P14	431
42408-06	389	42506-08	180	42531-50	181	42562-20	128	42599-08	140	42630P12	426	42669S14	431
42408-08	389	42506-10	180	42532-29	181	42562-25	128	42607-05	218	42630P13	426	42670B14	430
42413-24	400	42506-12	180	42532-58	181	42562-30	128	42609-10	130	42630S01	425	42670N14	430
42414-05	400	42506-14	180	42533-23	218	42563-00	141	42609-15	130	42630S02	425	42670W14	430
42414-10	400	42506-16	180	42533-26	218	42563-44	141	42609-20	130	42630S03	425	42674P18	421
42414-15	400	42506-18	180	42533-31	218	42565-00	141	42609-23	130	42630S04	425	42674P22	421
42414-20	400	42507-12	180	42533-36	218	42566-03	140	42609-25	130	42630S05	425	42674P30	421
42417-22	400	42508-00	181	42533-40	218	42569-04	145	42614-04	275	42630S06	425	42674S18	421
42420-06	398	42508-01	181	42534-26	181	42570-32	146	42614-05	275	42630S07	425	42674S22	421
42420-08	398	42509-25	127	42534-32	181	42570-91	576	42614-06	275	42630S08	426	42674S30	421
42445-03	406	42509-50	127	42534-41	181	42570-92	576	42614-07	275	42630S09	426	42676P15	427
42445-04	406	42509-60	127	42535-24	184	42570-94	576	42614-21	218	42630S10	426	42676P20	427
42445-05	406	42509-99	127	42535-32	184	42570-99	576	42615-04	128	42630S11	426	42676S15	427
42446-04	406	42510-00	180	42535-49	184	42571-20	146	42616-04	128	42630S12	426	42676S20	427
42450-00	492	42511-20	180	42537-40	183	42572-24	146	42617-04	391	42630S13	426	42677P14	422
42450-AD	493	42511-25	180	42537-50	183	42573-31	146	42617-05	391	42631P30	433	42677S14	422
42451-11	493	42511-30	180	42537-80	183	42573-91	576	42617-06	391	42632-01	423	42678P14	430
42451-12	493	42511-35	180	42538-00	183	42573-92	576	42617-07	391	42632-02	423	42678S14	430
42452-14	494	42511-40	180	42538-01	183	42573-94	576	42620-02	428	42632-03	423	42678W14	430
42452-23	494	42511-56	180	42538-02	183	42573-99	576	42620P01	427	42632-04	423	42679P12	430
42452-35	482	42511-60	180	42538-03	183	42574-37	147	42620P02	427	42650-10	139	42679S12	430
42452-53	493	42511-70	180	42538-04	183	42574-90	577	42620P03	427	42650-11	139	42680-13	434

Cod.	pag.	Cod.	pag.	Cod.	pag.	Cod.	pag.	Cod.	pag.	Cod.	pag.	Cod.	pag.	Cod.	pag.
42681-16	434	42721P12	414	42826-37	295	42907-10	124	42967-03	479	44028-19	523	44084-01	542		
42684P08	428	42721P18	414	42854-06	481	42907-30	124	42967-04	479	44029-00	519	44084-02	542		
42684S08	428	42721P22	414	42854-07	481	42907-35	124	42967-05	479	44030-03	535	44084-03	542		
42685-22	433	42721P27	414	42854B25	125	42907-40	124	42967-06	479	44031-01	535	44084-04	542		
42688P18	413	42721P30	414	42854B30	125	42920-02	306	42967-07	479	44031-02	535	44085-01	542		
42688P22	413	42721P40	414	42854C25	125	42921-00	397	42967-08	479	44031-04	519	44085-02	542		
42688P30	413	42721S12	414	42854C30	125	42922-08	395	42967-11	482	44031-05	519	44085-03	542		
42688S18	413	42721S18	414	42854G25	126	42923-07	306	42967-13	479	44033A23	524	44085-04	542		
42688S22	413	42721S22	414	42854G30	126	42924-02	395	42967-14	479	44033B23	524	44089-12	543		
42688S30	413	42721S27	414	42854K25	125	42926-12	395	42967-15	479	44033B38	524	44093-00	477		
42689-15	431	42721S30	414	42854K30	125	42927-02	395	42967-16	479	44034-11	524	44093-01	477		
42690-15	431	42723P10	433	42854R25	125	42928-00	395	42967-17	479	44040-40	520	44094-00	513		
42691P12	413	42723S10	433	42854R30	125	42929-01	395	42967-18	479	44041-00	520	44094-03	514		
42691P18	413	42725P10	433	42854Y25	125	42929-02	395	42967-35	480	44041-01	520	44094-04	514		
42691P22	413	42725S10	433	42854Y30	125	42929-03	396	42967-43	481	44041-03	520	44094R00	513		
42691P30	413	42727-09	429	42862-00	125	42931-19	394	42967-53	480	44041-04	520	44094R00	514		
42691P40	413	42727-12	429	42863-00	125	42935-19	393	42967-63	479	44041-05	520	44094R00	514		
42691S12	413	42727-18	429	42864-10	182	42935-26	393	42967-64	479	44042-00	520	44094-RE	578		
42691S18	413	42727-22	430	42870-50	487	42936-23	484	42967-65	479	44043-00	520	44095-12	543		
42691S22	413	42727-30	430	42870-59	484	42936-24	484	42967-66	479	44044-00	520	44095-18	543		
42691S30	413	42727-38	430	42873-01	394	42936-28	484	42967-67	479	44046-20	522	44095-30	535		
42694P02	417	42728-09	429	42873-02	394	42939-15	406	42967-68	479	44046-40	522	44095-32	535		
42694P04	417	42728-12	429	42874-01	486	42939-AA	577	42967-73	479	44046-60	522	44096-80	543		
42694P05	416	42728-18	429	42874-02	486	42940-03	472	42967-74	479	44047-17	519	44096B80	543		
42694P06	417	42728-22	430	42874-03	487	42942-10	405	42967-75	479	44047-19	519	44096G80	543		
42694P09	416	42728-30	430	42874-04	487	42942-16	405	42967-76	479	44047-22	519	44096R80	543		
42694P11	416	42728-38	430	42875-17	393	42944-23	393	42967-77	479	44047-25	519	44096Y80	543		
42694P12	414	42728S18	429	42875-20	393	42945-18	393	42967-78	479	44047-28	519	44097-00	542		
42694P13	416	42741-22	422	42875B17	394	42945-23	393	42967M43	481	44048-99	358	44099-03	352		
42694P18	414	42742-22	422	42875B20	394	42945-27	393	42967M53	480	44055-10	355	44100-01	352		
42694P22	414	42746P12	412	42876-12	394	42946-23	484	42968-38	484	44055-20	355	44100-02	352		
42694P30	414	42746P18	412	42876-20	394	42946-37	484	42968-42	480	44055-25	355	44100-04	352		
42694P40	414	42746P22	412	42876-25	394	42947-23	484	42968M42	480	44055-30	355	44101-03	352		
42694S02	417	42746P30	412	42877-17	393	42947-30	484	42969-31	480	44055-35	355	44101-AA	578		
42694S07	416	42746P40	412	42877-25	393	42947-40	484	42969M31	480	44055-40	355	44102-24	348		
42694S09	416	42746P50	412	42878-17	392	42948-18	393	42972-01	480	44055-50	355	44103-03	352		
42694S10	416	42746P80	412	42878-25	392	42948-20	393	42972-02	480	44055C30	355	44103-04	352		
42694S12	414	42746S18	412	42879K12	393	42948-23	393	42972-03	480	44055C40	355	44103-06	352		
42694S13	416	42746S22	412	42879K15	393	42948-25	393	42972-04	480	44055G30	355	44103-AA	578		
42694S18	414	42746S30	412	42879K22	393	42949-26	481	42972-28	480	44055G40	355	44103-AB	578		
42694S22	414	42747P12	412	42879K25	393	42949B26	481	42973-30	480	44056-01	354	44103-AC	578		
42694S30	414	42747P18	412	42879M12	393	42950-01	380	42973-45	480	44056-04	354	44104-01	307		
42695P22	421	42747S12	412	42879M15	393	42950-02	380	42973-60	480	44056-06	354	44104-02	307		
42695S22	421	42747S18	412	42879M22	393	42950-03	380	42974B13	393	44056-11	354	44105-00	345		
42696P22	421	42749P18	412	42879M25	393	42950-04	380	42974M13	393	44056-21	354	44106-12	352		
42696S22	421	42749P22	412	42881-24	392	42950-05	380	42979-00	473	44057-04	354	44106B05	351		
42701-10	421	42749S18	412	42881-25	392	42950-06	380	42979-36	473	44057-06	354	44106B10	351		
42701P10	421	42749S22	412	42881-26	392	42950-08	380	42979-45	473	44058-10	355	44106B20	351		
42702-10	422	42763-02	437	42882-23	343	42950-09	380	42981-73	473	44058-20	355	44106B25	351		
42702P10	422	42763P16	437	42882-28	343	42950-92	380	42982-08	473	44058-25	355	44106G05	350		
42703-10	421	42763S16	437	42900-15	124	42950-93	380	42988-99	466	44058-30	355	44106G10	350		
42703S10	421	42764M15	432	42900-24	124	42950-94	380	42988C99	466	44058-40	355	44106G20	350		
42704-10	422	42764P16	429	42901-20	124	42951-08	406	42988G99	466	44058-50	355	44106G25	350		
42704S10	422	42764P21	429	42901-25	124	42951-57	406	42990-16	481	44060-01	354	44106O05	351		
42705M15	432	42764S16	429	42901-30	124	42951-59	407	42990-20	481	44060-02	354	44106O10	351		
42705P10	422	42764S21	429	42901-35	124	42952-05	406	42990-29	481	44060-50	126	44106O20	351		
42705P16	429	42767P12	427	42901-40	124	42953-04	397	42990M16	481	44060-51	353	44106O25	351		
42705P21	429	42767P15	427	42902-30	125	42954-04	406	42990M20	481	44060-80	126	44106R05	351		
42705S10	422	42767P20	427	42902-31	125	42954-18	406	42990M29	481	44060-99	353	44106R10	351		
42705S16	429	42767S12	427	42902B30	335	42955-00	397	42991-25	481	44061-08	126	44106R20	351		
42705S21	429	42767S15	427	42902C30	335	42956-19	343	42991-32	481	44061-09	126	44106R25	351		
42706P10	422	42767S20	427	42902G30	335	42956-24	343	42991M25	481	44061-12	126	44106W05	350		
42706S10	422	42785S20	436	42903-29	126	42956-28	343	42991M32	481	44061-14	126	44106W10	350		
42713P10	422	42786S20	436	42904-01	125	42959-12	400	42993-40	481	44061B10	126	44106W20	350		
42713S10	422	42796P16	429	42904-02	125	42959-13	400	42993M40	481	44061B12	126	44106W25	350		
42714P10	422	42796P23	429	42904-03	125	42962-26	308	44009-00	519	44061G10	126	44106Y05	351		
42714S10	422	42796S16	429	42907-01	124	42962-30	495	44020-21	519	44061G12	126	44106Y10	351		
42717P16	429	42796S23	429	42907-02	124	42962-44	495	44023-00	518	44061R10	126	44106Y20	351		
42717S16	429	42798P11	429	42907-03	124	42962B30	495	44023-AA	577	44061R12	126	44106Y25	351		
42718P18	413	42798S11	429	42907-04	124	42962B44	495	44024-00	518	44061Y10	126	44107B05	352		
42718P22	413	42801P14	436	42907-06	124	42962C26	309	44025-50	518	44061Y12	126	44107B10	352		
42718S18	413	42801S14	436	42907-07	124	42962C44	495	44026-60	536	44077-00	541	44107B20	352		
42718S22	413	42822-00	293	42907-08	124	42964-53	185	44027-00	519	44077-10	541	44107B25	352		
42720-01	432	42826-32	295	42907-09	124	42964-60	185	44027-AA	577	44077-CC	541	44107G05	351		

NUMERICAL INDEX INDICE NUMERICO NUMERISCH INDEX INDEX NUMERIQUE INDICE NUMERICO

Cod.	pag.	Cod.	pag.	Cod.	pag.	Cod.	pag.	Cod.	pag.	Cod.	pag.	Cod.	pag.
44107G10	351	44169B06	541	44214-25	64	44314G06	100	44374-36	73	44455B09	278	44478-30	385
44107G20	351	44169B14	541	44215S16	66	44314O06	100	44374-40	73	44456-14	278	44478-31	385
44107G25	351	44169R06	541	44216S16	66	44314R06	100	44374-44	73	44456B14	278	44478-32	385
44107O05	351	44169R25	541	44217-45	65	44314Y06	100	44375-25	73	44457-32	278	44478-33	385
44107O10	351	44170-00	539	44218R30	64	44315A06	100	44376-40	73	44457B32	278	44478-34	385
44107O20	351	44170-01	540	44218R40	64	44315B06	100	44378-06	73	44459-28	279	44478-35	385
44107O25	351	44171-24	541	44219R24	63	44315G06	100	44379-03	392	44459B28	279	44480-00	384
44107R05	351	44171-50	541	44219R26	63	44315O06	100	44379-05	392	44461-20	278	44480-01	384
44107R10	351	44172-30	541	44219R31	63	44315R06	100	44382A06	98	44461B20	278	44480-03	383
44107R20	351	44173-00	541	44220-AA	68	44315Y06	100	44382B06	98	44462-25	278	44480-04	384
44107R25	351	44174-24	538	44220S15	67	44317A06	100	44382G06	98	44462B25	278	44480-05	384
44107W05	351	44174-AA	578	44220S24	66	44317B06	100	44382O06	98	44463-11	277	44480-06	383
44107W10	351	44175-15	539	44221S30	66	44317G06	100	44382Y06	98	44464-23	277	44480-07	383
44107W20	351	44176-30	539	44222S20	66	44317O06	100	44383O06	98	44465-24	277	44480-08	383
44107W25	351	44177-12	538	44222S28	66	44317R06	100	44383Y06	98	44466-07	465	44480-09	384
44107Y05	351	44178-01	538	44224-22	65	44317Y06	100	44384A06	98	44466-11	371	44480-10	383
44107Y10	351	44178-02	538	44224S22	65	44322-02	83	44384O06	98	44466-12	371	44480-11	383
44107Y20	351	44183-01	545	44225-22	65	44322-04	83	44384R06	98	44466-13	371	44480-12	383
44107Y25	351	44183-A3	545	44226S30	65	44322-06	83	44384Y06	98	44466-14	371	44480-15	383
44108-01	350	44183-A4	545	44227-30	65	44332-03	97	44385A06	98	44466-15	371	44480-16	383
44110-00	356	44184-01	545	44228S23	66	44332-06	97	44385B06	98	44466-16	465	44480-17	384
44110-01	356	44184-A3	545	44230S14	66	44332B06	98	44385G06	98	44470-03	467	44480-18	384
44110-02	356	44184-A4	545	44232S16	66	44333-03	97	44385O06	98	44470-04	467	44480-19	384
44110-03	356	44185-50	488	44232S20	66	44333-06	97	44385R06	98	44470-11	467	44480-20	383
44110-04	356	44185-70	488	44233-20	66	44333B06	98	44385Y06	98	44470-12	467	44501-01	71
44110-05	356	44187-40	488	44234-12	36	44334-03	97	44387A06	98	44470-13	467	44501-02	71
44110-06	356	44187-60	488	44234-16	36	44334-06	97	44387B06	98	44470-14	467	44501-03	71
44111-02	355	44201-01	36	44234S16	67	44335-03	97	44387G06	98	44470-22	467	44501-04	71
44112-01	356	44201-03	36	44237S15	67	44335-06	97	44387O06	98	44470-24	467	44502-01	71
44112-02	356	44201-10	36	44240-08	68	44335B06	98	44387R06	98	44470-30	467	44502-02	71
44114-01	356	44201B10	35	44240S08	68	44337-03	97	44387Y06	98	44470-31	467	44502-03	71
44114-02	356	44201B12	35	44241-19	68	44337-06	97	44390-07	73	44470-38	467	44502-04	71
44114-03	356	44201N10	35	44242-00	68	44337B06	98	44390-09	73	44470-40	467	44503-01	71
44114C03	356	44201N12	35	44243-00	68	44338-03	97	44390-11	73	44470-73	467	44503-02	71
44114G03	356	44201N16	62	44244S36	67	44338-06	97	44390-15	73	44470-74	467	44503-03	71
44118-10	356	44201N20	62	44245S32	67	44339-03	97	44390-18	73	44470-75	467	44503-04	71
44118-20	356	44201N24	62	44246S14	67	44339-06	97	44390-23	73	44473-02	295	44511-27	525
44118-25	356	44201N28	62	44246S17	67	44342-06	100	44391-12	73	44473-03	295	44511-34	525
44118-30	356	44201N32	62	44247S16	36	44343-06	100	44394-18	73	44473-05	368	44511-38	525
44118-35	356	44201O10	35	44248S60	370	44344-06	100	44394-21	73	44473-07	368	44511-42	525
44118-40	356	44201O12	35	44250S30	370	44345-06	100	44395-18	73	44473-08	368	44511-63	525
44118-50	356	44201R10	35	44252-32	64	44346-06	100	44397-18	73	44473-31	367	44511-90	525
44119-01	356	44201R12	35	44253-30	63	44347-06	100	44412-00	83	44473-32	367	44511E21	524
44119-02	356	44201R16	62	44254-30	370	44352-30	509	44421-00	83	44473-33	367	44511E63	524
44119-03	356	44201R20	62	44256-02	371	44352-40	509	44422-00	83	44473-34	367	44511E90	524
44119-04	356	44201R24	62	44256-03	371	44355-30	509	44423-00	83	44474-09	311	44512-34	525
44119-06	356	44201R28	62	44256-04	371	44355-40	509	44430-60	208	44474-13	311	44512-42	525
44130-01	354	44201R32	62	44258-60	371	44357B07	281	44430-61	209	44474-24	311	44512-63	525
44130-02	354	44201V10	35	44264-35	371	44364-04	133	44431-46	209	44474-25	311	44512-90	525
44130-03	354	44201V12	35	44265-35	371	44364-10	133	44431-60	209	44474-33	311	44512E12	524
44135-02	354	44202-10	36	44270-16	36	44364-25	133	44432-21	83	44474-34	311	44512E21	524
44141-01	540	44202N12	35	44271-33	67	44364-40	133	44450-11	279	44474-38	311	44513-34	525
44141-03	540	44202N25	62	44272-11	68	44364-80	133	44450-12	278	44474-39	311	44513-38	525
44142-40	540	44202N29	62	44272-14	68	44364-99	133	44450-13	279	44476-30	472	44513-54	525
44147-30	540	44202R12	35	44272-17	68	44365-04	133	44450-15	279	44476-31	472	44513-63	525
44147-31	540	44202R29	62	44273-24	68	44365-10	133	44450-17	278	44476-51	472	44513-90	525
44147-32	540	44204R24	62	44273-32	68	44365-25	133	44450-21	278	44476-52	471	44513E12	524
44147-33	540	44204R28	62	44274-24	68	44365-40	133	44450-23	279	44476-53	471	44513E21	524
44149-03	539	44204R32	62	44275A26	61	44365-80	133	44450B11	279	44477-76	471	44521-16	525
44150-19	539	44207-20	62	44275B26	61	44365-99	133	44450B12	278	44477-77	471	44521-21	525
44151-00	539	44208G00	68	44275G26	61	44371-24	73	44450B13	279	44477-78	471	44521-31	525
44151-AA	539	44208R00	68	44312A06	100	44371-28	73	44450B15	279	44477-79	471	44521E10	525
44151-AB	539	44209R26	63	44312B06	100	44371-32	73	44450B17	278	44477-80	471	44522-16	525
44151-AC	539	44209R32	63	44312G06	100	44371-36	73	44450B21	278	44477-81	471	44522-21	525
44160-03	539	44210-26	64	44312O06	100	44371-40	73	44450B23	279	44478-20	384	44522-31	525
44160-AA	578	44210-32	64	44312R06	100	44371-44	73	44451-22	278	44478-21	384	44522E10	525
44161-00	540	44210-42	64	44312Y06	100	44371-48	73	44451B22	278	44478-22	384	44628-02	521
44164-00	540	44210S32	64	44313B06	100	44372-26	73	44452-31	278	44478-23	385	44628-04	521
44165-35	540	44211R01	63	44313G06	100	44372-32	73	44452B31	278	44478-24	385	44628-06	521
44165-40	540	44211R02	64	44313O06	100	44372-36	73	44453-14	278	44478-25	385	44628-08	521
44165-50	540	44211R03	63	44313R06	100	44372-40	73	44453B14	278	44478-26	385	44628-11	521
44166-28	540	44212-30	64	44313Y06	100	44374-22	73	44454-11	278	44478-27	385	44628-17	521
44167-13	540	44213-24	64	44314A06	100	44374-25	73	44454B11	278	44478-28	385	44628-20	521
44168-12	541	44213-36	64	44314B06	100	44374-32	73	44455-09	278	44478-29	385	44628-21	521

Cod.	pag.	Cod.	pag.	Cod.	pag.	Cod.	pag.	Cod.	pag.	Cod.	pag.	Cod.	pag.
44628-22	521	44702T36	442	44833-99	532	44860-25	468	44940-12	341	44970-20	528	47018-50	231
44628-23	521	44702Y21	452	44837-05	494	44860-27	468	44940-13	341	44970-34	528	47020-15	206
44629-03	522	44702Y28	452	44837-20	494	44871-20	342	44940-14	341	44972-20	527	47020-20	206
44629-04	522	44702Y36	452	44837-25	494	44871-21	342	44940-16	341	44972-25	527	47020-30	206
44629-05	522	44703B27	446	44837B05	494	44871-22	342	44940-17	341	44972-33	527	47020-35	206
44629-06	522	44703B34	446	44837B20	494	44871-23	342	44940-18	341	44974-21	528	47021-35	206
44629-07	522	44703C27	444	44837B25	494	44871-28	342	44940-19	341	44974-27	528	47021-45	206
44629-B7	522	44703C34	444	44840-08	470	44871-29	342	44940-24	341	44974-31	528	47022-12	218
44629-R4	522	44703R27	440	44840-10	470	44871-30	342	44940-25	341	44975-50	227	47023-01	306
44630-01	154	44703R34	440	44840-18	470	44871-31	342	44940-26	341	44975C50	518	47023-02	306
44630-02	154	44703S27	448	44840-30	470	44871-32	342	44940-32	341	44975H50	227	47023-03	306
44630-03	154	44703S34	448	44840-31	470	44871-33	342	44940-33	341	44976-01	529	47023-04	306
44630-04	154	44704B22	446	44840-32	470	44871-34	342	44940-34	341	44976-02	529	47024-06	215
44630-05	155	44704C22	444	44840-40	470	44871-35	342	44941A05	327	44976-03	529	47024-10	215
44630-06	155	44704R22	440	44840-41	470	44871B20	342	44941B05	331	44976-04	529	47025-06	215
44630-07	155	44704S22	448	44840-42	470	44871B21	342	44941C05	331	44977-12	529	47025-10	215
44701B25	446	44705C37	445	44840-50	471	44871G20	342	44941G05	331	44978-20	528	47026-06	215
44701B32	446	44706C31	444	44840-51	471	44871G21	342	44942-01	343	44979-02	529	47027-11	215
44701B36	446	44706C40	444	44840-52	471	44871L20	342	44942-02	343	44979-04	529	47027-12	215
44701B40	446	44706R31	440	44840-54	471	44871L21	342	44942-03	343	44979-05	529	47027-14	215
44701C22	444	44706R40	440	44840-55	471	44871R20	342	44942-04	343	44979-06	529	47027-15	215
44701C25	444	44706S31	448	44840-56	471	44871R21	342	44942-05	343	44982-04	275	47027-16	215
44701C32	444	44706S40	448	44840-57	471	44873-08	310	44942-06	319	44982-06	275	47028-12	215
44701C36	444	44707C40	444	44840-58	471	44873-16	310	44942-07	319	44982-10	275	47029-12	215
44701C40	444	44707R40	440	44841-18	464	44874-08	309	44942-10	319	44983-01	526	47030-30	216
44701K22	453	44707S40	448	44841-21	464	44874-16	309	44942-11	319	44983-02	527	47031-44	213
44701K25	453	44708B28	446	44841-26	464	44877-11	95	44944A07	327	44983-03	527	47031-46	213
44701K32	453	44708B30	446	44841-37	464	44877-12	95	44944C07	327	44986-17	527	47032-10	216
44701K36	453	44708C28	445	44841-51	464	44877-13	96	44944G07	327	44986-21	527	47032-20	216
44701K40	453	44708C30	445	44841B51	464	44877-14	96	44945C05	328	44986-28	527	47033-08	216
44701M25	443	44708R28	441	44842-30	464	44877-16	96	44945G05	328	44987-11	528	47033-12	216
44701M32	443	44708R30	441	44842-31	464	44877-24	95	44946-04	474	44987-60	528	47033-14	216
44701M40	443	44708S28	449	44842-35	464	44877B11	95	44946-20	402	44987C11	529	47033-50	213
44701R22	440	44708S30	449	44842-53	464	44877B12	95	44946-29	402	44987C60	529	47034-23	216
44701R25	440	44709B31	446	44842B31	464	44877B13	96	44946-40	402	44987C62	529	47034-50	216
44701R32	440	44709C31	445	44842B53	464	44877B14	96	44946B05	474	44990-15	342	47034-51	216
44701R36	440	44709R31	441	44843-11	464	44877B16	96	44947-00	183	44990-24	342	47034-52	216
44701R40	440	44709S31	449	44843-12	464	44877B24	95	44948-07	332	44990-29	342	47035-40	216
44701S22	448	44710R20	441	44843-13	464	44878-11	95	44949-01	332	44990-36	342	47035-48	216
44701S25	448	44710S20	449	44843-14	464	44878-12	95	44949-02	332	44990-48	342	47036-30	216
44701S32	448	44711-01	454	44843-24	464	44878-13	96	44949-03	332	44991-22	127	47036-35	216
44701S36	448	44711-02	454	44843B11	464	44878-14	96	44949-04	332	44991-24	127	47036-40	216
44701S40	448	44713C02	456	44843B12	464	44878-16	96	44949-05	332	44991-28	127	47036-45	216
44701T25	442	44713K02	456	44843B13	464	44878-24	95	44949-06	332	44991-29	127	47036-50	216
44701T32	442	44713R02	456	44843B14	464	44878B11	95	44949-07	332	44992-02	390	47036-60	216
44701T40	442	44713S02	456	44843B24	464	44878B12	95	44949-08	332	44992-03	389	47037-30	216
44701Y25	452	44801-09	534	44844-01	463	44878B13	96	44949-09	332	44992-10	391	47037-40	216
44701Y32	452	44801-18	535	44844B01	463	44878B14	96	44949-10	333	44992-15	390	47038-50	216
44701Y36	452	44803-10	533	44845-30	465	44878B16	96	44950-15	392	44993-01	391	47038-60	216
44701Y40	452	44803-20	533	44845-31	310	44878B24	95	44950-20	392	44994-00	390	47041-01	274
44702B21	446	44803-30	533	44845-38	465	44884-12	495	44950-25	392	44995-10	391	47041-02	274
44702B28	446	44807-18	534	44845-41	465	44884-19	495	44950-30	392	44995-14	390	47041-05	274
44702B36	446	44807-28	534	44845-51	465	44884-25	495	44950-38	392	44995-15	390	47041-07	275
44702C18	444	44807-36	534	44846-05	463	44884B12	495	44960-01	297	44997-22	127	47042-19	275
44702C21	444	44818-11	96	44846-09	463	44884B19	495	44960-02	297	44997-24	127	47042-22	275
44702C28	444	44818-12	96	44846-13	463	44884B25	495	44960-03	297	44997-26	127	47042-25	275
44702C36	444	44818-13	96	44846B05	371	44885-19	495	44960-04	297	44997-28	127	47043-27	275
44702K18	453	44818-14	96	44846B09	463	44885-25	495	44960-06	297	44998-31	127	47043-35	275
44702K21	453	44818-16	96	44846B13	463	44930-10	531	44960-07	297	44999-09	389	47043-42	275
44702K28	453	44819-02	534	44847-09	463	44930-20	531	44960-10	297	44999-16	389	47060-06	226
44702K36	453	44819-03	534	44847-13	463	44932-15	531	44960-11	297	46116-15	347	47060-07	226
44702M21	443	44820-80	534	44847-20	463	44932-20	531	44960-13	297	46118-20	402	47060-09	226
44702M28	443	44820-99	534	44847B09	463	44934-30	531	44960K10	298	46120-18	402	47060-10	226
44702M36	443	44822-80	535	44847B13	463	44936-01	531	44960K11	298	46120-22	402	47060-12	226
44702R18	440	44822-99	535	44847B20	463	44936-22	531	44961-02	528	46120-24	402	47060-14	226
44702R21	440	44825-20	536	44850-11	465	44936-25	531	44961-03	296	46123-00	405	47060-16	226
44702R28	440	44825-40	536	44850-12	466	44937-01	530	44961-04	528	46796-00	357	47060-18	226
44702R36	440	44826-00	534	44850-13	281	44937-02	530	44961-06	528	47005-24	229	47060-20	226
44702S18	448	44826-20	536	44850B11	465	44940-01	340	44961M03	296	47006-25	229	47060-22	226
44702S21	448	44830-52	532	44850B12	466	44940-02	340	44962-01	297	47007-26	233	47060-24	226
44702S28	448	44830-72	532	44850B13	281	44940-06	340	44962-05	298	47010-20	207	47060-26	226
44702S36	448	44830-99	532	44850G12	466	44940-08	341	44968-00	529	47011-01	220	47060-30	226
44702T21	442	44831-52	532	44851-01	466	44940-10	341	44970-10	527	47014-35	231	47062-18	226
44702T28	442	44832-99	532	44860-21	468	44940-11	341	44970-15	527	47018-30	231	47062-20	226

NUMERICAL INDEX INDICE NUMERICO NUMERISCH INDEX INDEX NUMERIQUE INDICE NUMERICO

Cod.	pag.	Cod.	pag.	Cod.	pag.	Cod.	pag.	Cod.	pag.	Cod.	pag.	Cod.	pag.
47062-22	226	47106-55	206	47302-10	189	47357-07	200	47404-04	194	47529-07	221	47546-18	223
47063-01	226	47106-60	206	47303-10	189	47357-08	201	47404-08	195	47530-14	221	47546-30	223
47063-02	226	47106-65	206	47304-06	189	47357-09	201	47411-01	191	47530-16	221	47546-40	223
47063-05	226	47106-70	206	47304-10	189	47357-10	201	47411-02	191	47530-18	221	47546-41	224
47063-07	226	47106-75	206	47304-12	189	47357-11	201	47411-03	192	47530-20	221	47546-42	224
47063-10	226	47107-00	208	47305-12	189	47357-20	199	47411-08	191	47530-22	221	47546-43	224
47064-18	226	47108-00	208	47306-10	189	47357-21	199	47412-08	191	47530-24	221	47546-51	224
47064-22	226	47110-23	208	47307-10	189	47357-22	199	47413-01	191	47530-26	221	47546-52	224
47064-26	226	47111-30	207	47308-10	189	47357-24	199	47413-08	191	47530-28	221	47546-53	224
47064-30	226	47111-40	207	47310-10	189	47357-28	200	47414-03	190	47530-30	221	47547-22	223
47066-03	226	47111-46	207	47312-10	189	47357-29	200	47415-03	190	47532-06	221	47547-26	223
47066-04	226	47111-55	207	47314-10	189	47357-30	200	47416-06	190	47532-07	221	47547-30	223
47066-05	226	47112-34	207	47315-10	189	47357-31	200	47417-06	190	47532-08	221	47548-02	223
47066-06	226	47112-45	207	47316-10	189	47357-38	205	47419-10	190	47532-12	221	47548-03	223
47066-07	226	47112-50	207	47316-12	189	47357-40	204	47421-09	196	47532-14	221	47548-04	223
47066-08	226	47113-03	208	47316-20	189	47357-41	204	47422-26	196	47532-16	221	47548-05	223
47068-12	226	47118-30	207	47317-10	189	47357-42	204	47425-01	197	47532-18	221	47600-16	133
47068-15	226	47118-40	207	47317-12	189	47357-43	204	47425-02	197	47532-20	221	47600-20	133
47069-10	226	47118-55	207	47321-12	190	47357-44	204	47425-03	197	47532-22	221	47600-24	133
47069-12	226	47118-65	207	47322-12	190	47357-50	204	47425-04	197	47532-24	221	47600-28	133
47069-14	226	47117-04	203	47323-12	190	47357-51	204	47425-05	197	47532-26	221	47600-32	133
47069-16	226	47127-06	203	47324-12	190	47370-01	196	47425-06	197	47533-07	221	47600-36	133
47069-18	226	47127-08	203	47325-10	190	47370-02	196	47425-08	197	47533-08	221	47600-40	133
47069-20	226	47130-25	220	47326-10	190	47370-03	196	47425-09	197	47533-09	221	47603-25	127
47070-37	219	47130-30	220	47327-12	190	47370-08	191	47425-10	197	47533-10	221	47603-27	127
47070-48	219	47130-35	220	47328-15	190	47371-08	194	47425-11	197	47533-12	221	47604-08	128
47070-60	219	47130-40	220	47331-15	190	47372-08	192	47425-26	197	47533-14	221	47604-10	128
47074-01	219	47130-45	220	47332-12	190	47373-01	193	47425-29	197	47533-16	221	47604-12	128
47074-02	219	47130-50	220	47333-15	190	47373-02	196	47425-30	197	47533-18	221	47604-15	128
47074-03	219	47130-55	220	47334-12	190	47373-08	192	47425-32	197	47533-20	221	47604-18	128
47074-04	219	47130-60	220	47335-12	190	47374-01	195	47426-01	197	47533-22	221	47604-20	128
47074-05	219	47131-30	220	47336-42	190	47374-02	195	47426-07	197	47533-24	221	47604-24	128
47074-06	219	47131-60	220	47350-01	202	47374-08	195	47510-07	222	47533-26	221	47604-30	128
47074-07	219	47200-01	206	47351-01	202	47375-01	195	47510-09	222	47533-28	221	47605-23	127
47074-08	219	47200-02	206	47352-01	202	47375-08	195	47510-11	222	47533-30	221	47606-02	128
47075-20	218	47207-20	203	47353-02	203	47376-08	192	47510-13	222	47533-32	221	47606-05	128
47075-30	218	47207-25	203	47353-04	203	47377-01	194	47510-15	222	47534-00	221	47606-10	128
47075-45	218	47207-30	203	47353-06	203	47377-02	193	47510-17	222	47534-01	221	47606-20	128
47090-23	313	47208-01	202	47353-08	203	47377-03	193	47510-19	222	47534-06	221	47606-30	128
47092-01	313	47208-02	202	47353-10	203	47377-04	194	47510-21	222	47534-07	221	47606-50	128
47092-02	313	47208-03	202	47353-12	203	47377-05	194	47510-23	222	47534-08	221	47607-02	128
47093-24	138	47208-04	202	47353-14	203	47377-06	194	47510-25	222	47534-10	221	47607-05	128
47094-30	208	47208-05	202	47353-16	203	47377-08	191	47510-27	222	47534-16	221	47607-10	128
47098-18	209	47208-06	202	47353-18	203	47377-09	193	47510-29	222	47534-18	221	47607-20	128
47098-22	209	47208-07	202	47353-20	203	47377-10	193	47510-31	222	47534-20	221	47608-02	128
47098-26	209	47208-08	202	47353-22	203	47377-11	194	47511-07	222	47534-22	221	47609-02	129
47098-30	209	47208-09	202	47353-24	203	47377-12	197	47511-09	222	47534-24	221	47609-03	129
47099-30	309	47208-10	202	47354-02	203	47377-15	197	47511-11	222	47534-26	221	47609-04	129
47100-03	473	47208-11	202	47354-04	203	47378-01	196	47511-13	222	47534-28	221	47609-07	129
47100-04	473	47208-12	202	47354-06	203	47378-02	196	47511-15	222	47535-09	224	47609-09	129
47100-05	473	47208-13	202	47354-08	203	47378-08	191	47511-17	222	47535-12	224	47609-12	129
47100-06	473	47208-14	202	47354-10	203	47379-08	191	47511-19	222	47535-17	224	47609-13	129
47100-07	473	47208-15	202	47354-12	203	47380-08	195	47511-21	222	47535-19	224	47609-16	129
47100-08	473	47208-16	202	47354-14	203	47381-08	196	47511-23	222	47536-12	224	47610-18	132
47101-31	309	47208-17	203	47354-16	203	47382-06	194	47511-25	222	47536-14	224	47610-22	132
47101-40	208	47208-18	203	47354-18	203	47382-08	193	47511-27	222	47536-20	224	47610-26	132
47103-30	208	47208-19	203	47355-02	203	47383-08	195	47511-29	222	47538-23	224	47610-30	132
47103-32	208	47208-20	203	47355-04	203	47384-01	195	47511-31	222	47538-26	224	47611-01	133
47104-45	207	47208-21	203	47355-06	203	47384-08	195	47512-07	222	47540-02	224	47611-03	133
47105-28	206	47208-22	203	47355-08	203	47385-01	196	47512-09	222	47540-03	224	47611-05	133
47105-34	206	47208-23	203	47355-10	203	47385-08	196	47512-11	222	47540-04	224	47611-06	133
47105-40	206	47208-24	203	47355-12	203	47386-08	195	47512-13	222	47540-05	224	47611-09	133
47105-46	206	47212-01	205	47356-02	203	47387-01	192	47512-15	222	47541-02	223	47611-11	133
47105-50	206	47212-02	205	47356-04	203	47387-02	193	47512-17	222	47541-03	223	47611-13	133
47105-55	206	47212-03	205	47356-06	203	47388-06	197	47512-19	222	47541-04	223	47611-14	133
47105-60	206	47212-05	206	47356-08	203	47388-07	197	47512-21	222	47542-00	223	47611-15	133
47105-65	206	47214-86	204	47356-10	203	47388-08	197	47512-23	222	47542-18	224	47611-16	133
47105-70	206	47215-86	204	47356-12	203	47401-08	195	47512-25	222	47542-20	224	47611-19	133
47105-75	206	47219-29	205	47356-14	203	47402-01	192	47512-27	222	47542-22	224	47611-23	133
47106-28	206	47219-38	205	47356-16	203	47402-02	192	47512-29	222	47542-24	224	47612-01	210
47106-34	206	47219-55	205	47356-18	203	47402-08	192	47512-31	222	47542-26	224	47612-AA	578
47106-40	206	47250-12	204	47357-02	201	47404-01	195	47526-05	223	47544-20	223	47614-25	218
47106-46	206	47250-24	204	47357-03	201	47404-02	195	47527-55	223	47544-25	223	47615-25	218
47106-50	206	47301-12	189	47357-06	200	47404-03	195	47528-05	223	47544-30	223	47618-10	204

Cod.	pag.	Cod.	pag.	Cod.	pag.	Cod.	pag.	Cod.	pag.	Cod.	pag.	Cod.	pag.
47618-20	204	47658-03	235	47710-32	229	47740-13	261	47740-95	257	47742-24	253	47754-20	234
47621-01	217	47658-04	235	47711-08	229	47740-14	264	47740-96	264	47742-25	252	47754-24	234
47621-02	217	47658-05	235	47711-12	229	47740-15	262	47740-97	259	47742-27	251	47754-26	234
47621-03	217	47658-07	235	47711-22	229	47740-16	257	47740-98	263	47742-29	253	47754-28	234
47621-04	217	47659-01	234	47711-24	229	47740-17	259	47740-99	262	47742-30	251	47755-26	234
47621-05	217	47659-02	234	47711-26	229	47740-18	257	47740100	262	47742-31	251	47756-20	234
47621-06	217	47659-04	234	47712-20	229	47740-19	259	47740101	258	47742-33	253	47756-24	234
47621-07	218	47659-20	225	47712-24	229	47740-20	262	47740102	256	47742-34	252	47756-26	234
47621-08	218	47659-21	225	47712-28	229	47740-23	256	47740103	257	47742-37	252	47756-28	234
47621-11	301	47659-22	225	47712-32	229	47740-24	261	47740104	260	47742-41	251	47757-65	231
47621-12	302	47659-24	225	47713-22	229	47740-25	261	47740105	256	47742-42	252	47757-80	231
47622-01	198	47659-25	225	47714-26	230	47740-26	256	47740106	259	47742-47	253	47758-10	230
47622-02	198	47659-26	225	47714-28	230	47740-27	256	47740107	264	47742-48	253	47758-12	230
47622-03	198	47670-02	234	47715-30	230	47740-28	256	47740108	264	47742-51	252	47759-12	231
47622-04	198	47672-05	234	47717-35	230	47740-29	256	47740109	264	47742-56	252	47761-23	233
47622-26	198	47679-10	218	47718-20	230	47740-30	261	47740110	264	47742-61	253	47762-23	233
47625-03	218	47679-11	218	47719-10	230	47740-31	263	47740111	260	47743-03	265	47764-12	233
47626-55	213	47680-40	220	47719-24	230	47740-32	260	47740112	265	47743-05	265	47764-28	234
47627-01	213	47680-53	220	47720-06	231	47740-33	263	47740113	265	47743-10	265	47765-24	253
47630-28	198	47680-60	220	47720-08	231	47740-34	260	47740114	262	47743-13	265	47765-26	253
47631-08	198	47681-60	219	47720-10	231	47740-35	265	47740115	263	47743-15	268	47765-28	253
47631-12	198	47682-40	219	47720-12	231	47740-36	261	47740116	264	47743-16	268	47766-26	253
47640-25	217	47682-53	219	47721-08	231	47740-37	258	47740117	264	47744-01	270	47766-28	253
47640-35	217	47682-60	219	47721-10	231	47740-38	258	47740122	258	47744-02	269	47766-30	253
47640-50	217	47683-01	272	47721-12	231	47740-39	261	47740123	258	47744-03	270	47769-28	254
47640-59	217	47683-02	272	47722-05	232	47740-41	258	47740124	258	47744-04	269	47770-21	254
47642-30	217	47683-03	272	47722-06	232	47740-43	257	47740125	258	47744-05	269	47771-28	254
47642-40	217	47685-53	220	47722-07	232	47740-44	260	47740127	257	47744-06	269	47773-24	254
47642-50	217	47685-60	220	47722-08	232	47740-45	261	47740128	256	47744-07	269	47773-28	254
47642-60	217	47685-61	272	47722-10	232	47740-46	260	47740130	258	47744-10	270	47783-01	236
47642-70	217	47686-10	208	47723-05	232	47740-47	260	47740131	259	47744-19	270	47783-02	236
47644-30	217	47686-12	208	47723-06	232	47740-48	260	47740132	257	47744-21	270	47783-03	236
47644-40	217	47686-14	208	47723-07	232	47740-49	260	47740133	259	47744-30	268	47783-04	236
47644-50	217	47686-17	208	47723-08	232	47740-50	259	47740134	265	47744-31	268	47783-11	236
47644-60	217	47686-22	208	47723-10	232	47740-51	262	47740135	257	47744-32	268	47783-12	236
47644-70	217	47686-24	208	47723-12	232	47740-52	256	47740142	259	47744-34	268	47783-13	236
47645-40	217	47686-26	208	47724-06	232	47740-53	264	47740143	259	47744-36	270	47783-14	236
47645-60	217	47686-30	208	47724-08	232	47740-55	260	47740144	259	47744-37	271	47793-12	248
47645-75	217	47686-33	208	47724-10	232	47740-56	262	47740145	262	47744-48	269	47793-13	248
47646-40	217	47686-36	208	47724-11	232	47740-57	257	47741-00	268	47744-58	269	47793-15	248
47646-60	217	47686-42	208	47725-09	232	47740-58	257	47741-01	268	47744-59	269	47793-23	248
47646-75	217	47687-24	208	47726-07	231	47740-59	257	47741-02	268	47744-60	269	47793-26	248
47651-01	235	47688-60	220	47727-07	231	47740-60	257	47741-05	268	47744-62	269	47793-33	248
47651-02	235	47689-53	220	47728-06	231	47740-62	261	47741-07	266	47744-70	271	47793-40	248
47651-03	235	47689-60	220	47730-60	232	47740-63	261	47741-11	266	47744-71	271	47793-43	248
47651-04	235	47691-53	219	47731-12	233	47740-64	261	47741-13	266	47744-81	269	47793-45	248
47651-05	235	47691-64	219	47732-20	233	47740-65	261	47741-15	266	47745-02	250	47793-52	248
47651-07	235	47692-03	214	47733-18	230	47740-66	261	47741-20	266	47745-03	250	47793-55	248
47652-01	235	47692-11	214	47733-24	230	47740-67	263	47741-37	268	47745-04	250	47800-22	210
47652-02	235	47692-22	214	47733-30	230	47740-68	259	47741-38	268	47745-05	250	47801-20	210
47652-03	235	47692-25	214	47733-36	230	47740-69	256	47741-76	265	47745-06	249	47820-05	215
47652-04	235	47693-00	213	47734-18	230	47740-70	256	47741-77	266	47745-07	249	47820-07	215
47652-05	235	47693-03	214	47735-18	230	47740-71	261	47741-78	265	47745-08	249	47821-05	215
47652-07	235	47693-05	214	47736-30	231	47740-72	261	47742-00	254	47745-09	249	47821-07	215
47655-01	235	47693-10	214	47736-35	231	47740-73	264	47742-01	253	47745-10	249	47822-05	215
47655-02	235	47693-15	214	47736-40	231	47740-74	257	47742-02	251	47746-01	250	47822-07	215
47655-03	235	47694-03	210	47736-50	231	47740-75	257	47742-03	253	47746-02	250	47831-02	130
47655-04	235	47698-01	563	47738-23	230	47740-77	259	47742-04	253	47746-03	250	47832-00	488
47655-05	235	47698-01	211	47739-12	229	47740-79	262	47742-05	253	47746-04	250	47832-01	317
47655-07	235	47698-02	211	47739-24	229	47740-80	256	47742-06	253	47747-01	232	47832-02	488
47656-01	235	47698-03	212	47739-28	229	47740-81	260	47742-07	253	47747-03	232	47832-03	317
47656-02	235	47698-06	564	47739-32	229	47740-82	259	47742-08	253	47747-04	232	47832-04	317
47656-03	235	47698-06	212	47740-01	262	47740-83	257	47742-09	252	47747-05	233	47832-05	317
47656-04	235	47698-07	212	47740-02	258	47740-84	263	47742-10	253	47747-06	232	47832-10	488
47656-05	235	47705-22	230	47740-03	258	47740-85	261	47742-12	251	47747-07	233	47832-11	488
47656-07	235	47709-20	229	47740-04	260	47740-86	264	47742-13	252	47747-09	233	47832-12	488
47657-01	235	47709-24	229	47740-05	261	47740-87	262	47742-14	252	47747-10	232	47832-13	488
47657-02	235	47709-28	229	47740-06	256	47740-88	264	47742-15	253	47747-11	232	47832-14	488
47657-03	235	47709-32	229	47740-07	263	47740-89	258	47742-16	253	47748-35	233	47832-15	488
47657-04	235	47710-12	229	47740-08	263	47740-90	263	47742-17	252	47749-35	233	47833-04	199
47657-05	235	47710-16	229	47740-09	262	47740-91	263	47742-19	252	47750-06	233	47833-10	198
47657-07	235	47710-20	229	47740-10	257	47740-92	260	47742-20	252	47752-16	231	47837-09	198
47658-01	235	47710-24	229	47740-11	263	47740-93	256	47742-21	252	47752-21	231	47838-00	212
47658-02	235	47710-28	229	47740-12	263	47740-94	258	47742-23	252	47753-31	231	47840-11	211

NUMERICAL INDEX INDICE NUMERICO NUMERISCH INDEX INDEX NUMERIQUE INDICE NUMERICO

Cod.	pag.	Cod.	pag.	Cod.	pag.	Cod.	pag.	Cod.	pag.	Cod.	pag.	Cod.	pag.
47841-03	212	47861-11	238	47865-44	246	48252-12	408	48280-02	177	48290-10	275	48516-08	187
47841-04	212	47861-12	238	47865-66	246	48252B10	408	48280-03	109	48294-01	144	48516-09	187
47842-00	212	47861-13	238	47865-71	246	48252B12	408	48280-03	146	48294-02	144	48517-03	187
47843-00	149	47861-14	238	47865-72	246	48253B09	407	48280-04	107	48294-03	144	48518-01	187
47843-05	149	47861-15	238	47865-73	246	48255-01	407	48280-05	107	48294-04	144	48518-02	187
47844-01	211	47861-16	244	47865-74	246	48255-04	407	48280-06	108	48295-10	141	48519-01	187
47844-02	211	47861-17	245	47865-75	246	48278-01	113	48280-08	110	48300-29	285	48519-02	187
47844-06	211	47861-18	245	47865-76	246	48278-02	114	48280-09	108	48300-33	286	48519-03	187
47847-10	210	47861-19	245	47865-77	246	48278-03	114	48280-10	109	48300-42	286	48519-04	187
47847-12	210	47861-20	237	47865-80	246	48278-11	115	48280-10	137	48300-43	286	48523-01	186
47847-23	211	47861-21	237	47865-81	246	48278-12	112	48280-11	110	48306-01	358	48523-02	186
47848-07	211	47861-22	242	47865-82	246	48278-13	112	48280-12	108	48307-01	179	48523-03	186
47859-01	305	47861-23	242	47865-83	246	48278-14	117	48280-13	108	48307-02	179	48523-04	186
47859-02	305	47861-24	242	47870-50	242	48278-15	115	48280-15	110	48307-03	179	48524-01	186
47859-03	305	47861-25	237	47870-51	242	48278-16	115	48280-20	107	48310-14	333	48524-02	186
47860-17	238	47861-26	237	47870-52	242	48278-17	114	48280-21	107	48310-20	333	48524-03	186
47860-18	238	47861-27	237	47870-53	242	48278-18	117	48280-23	111	48311-20	333	48543-01	353
47860-21	238	47861-28	237	47876-11	246	48278-19	117	48280-24	109	48311-25	333	48543-02	353
47860-24	238	47861-29	237	47876-12	246	48278-20	113	48280-25	111	48312-25	333	49304-06	519
47860-27	239	47861-30	237	47876-13	246	48278-21	113	48280-25	177	48313-14	334	49335-01	538
47860-31	239	47861-31	238	47876-14	246	48278-24	111	48280-26	109	48313-18	334	49335-02	538
47860-35	239	47861-32	238	47885-01	143	48278-25	114	48280-27	177	48350-01	322	49336-00	538
47860-36	239	47861-33	242	47885-02	143	48278-27	116	48280-30	109	48350-02	322	49336-02	538
47860-37	239	47861-34	242	47885-03	143	48278-28	117	48280-31	109	48350-03	322	49337-00	538
47860-38	239	47862-03	243	47885-04	143	48278-31	113	48280-32	107	48350-04	322	49337-01	538
47860-39	239	47862-04	243	47885-05	143	48278-32	111	48280-34	110	48351-01	322	49371-09	544
47860-40	239	47862-05	243	48017-14	172	48278-33	111	48280-34	177	48351-02	322	49371-12	544
47860-42	239	47862-06	244	48017-25	172	48278-34	114	48280-35	109	48351-03	322	49372-01	523
47860-43	239	47862-07	244	48021-21	171	48278-35	114	48280-36	109	48352-01	321	49372-02	523
47860-44	239	47862-08	244	48032-30	178	48278-36	115	48280-37	108	48352-02	321	49372-03	523
47860-46	239	47862-09	244	48032-45	178	48278-37	113	48280-38	107	48352-03	321	49372-04	523
47860-48	239	47862-10	244	48032-60	178	48278-38	111	48280-39	107	48353-01	320	49372-05	523
47860-49	239	47862-31	241	48039-06	179	48278-39	111	48280-41	108	48354-01	320	49372-06	523
47860-50	239	47862-32	241	48040-00	178	48278-41	112	48280-45	107	48355-01	372	49372-11	523
47860-53	239	47862-33	241	48040-10	179	48278-42	112	48280-45	294	48356-01	373	49372-12	523
47860-55	239	47862-34	241	48040-50	179	48278-45	113	48280-46	108	48357-01	372	49372-13	523
47860-56	239	47862-35	241	48040-AA	578	48278-46	112	48280-47	110	48358-01	373	49372-14	523
47860-58	240	47862-36	241	48210-00	400	48278-47	114	48280-48	107	48359-01	372	49372-15	523
47860-60	240	47862-38	241	48211-00	400	48278-48	112	48280-49	108	48365-09	321	49372-16	523
47860-61	240	47862-39	241	48215-14	172	48278-49	112	48280-52	110	48366-09	322	49372-24	523
47860-62	240	47862-64	243	48215-30	172	48278-52	114	48280-53	110	48367-10	320	49373-05	544
47860-63	240	47862-65	243	48218-00	137	48278-53	114	48280-54	109	48368-05	372	49378-00	536
47860-66	240	47862-66	243	48220-00	146	48278-54	114	48280-59	108	48368-12	372	49379-00	536
47860-67	240	47862-67	243	48222-01	145	48278-55	112	48280-60	110	48368-20	372	49380-80	523
47860-68	240	47862-70	244	48223-00	357	48278-61	116	48280-61	110	48369-08	372	49381-01	523
47860-69	240	47862-72	244	48231-40	181	48278-62	116	48280-62	110	48369-14	372	49381-02	523
47860-70	240	47862-74	244	48231-45	181	48278-63	116	48280-63	110	48369-20	372	49381-03	523
47860-71	240	47862-80	246	48231-50	181	48278-64	115	48280-75	108	48370-10	321	49383-08	522
47860-73	240	47862-81	246	48232-40	578	48278-65	116	48280-85	109	48370-11	321	49383-20	522
47860-74	240	47862-82	246	48232-45	578	48278-66	115	48280-90	111	48371-10	320	49383-40	522
47860-75	240	47862-83	246	48232-50	578	48278-68	115	48280-91	110	48371-11	320	49384-03	522
47860-76	244	47862-84	246	48236-00	394	48278-69	115	48280-92	111	48371-12	320	49384-04	522
47860-77	245	47862-85	246	48236-01	394	48278-71	116	48280-92	177	48371C12	320	49384-05	522
47860-78	245	47862-86	246	48237-00	394	48278-73	116	48280-94	108	48372-08	372	49384-07	522
47860-81	240	47862-87	245	48237-01	394	48278-74	116	48280-95	111	48501-76	185	49384-11	522
47860-83	240	47862-88	245	48237-35	395	48278-75	113	48280-96	110	48505-01	185	49384-14	522
47860-84	240	47862-89	245	48237-99	394	48278-76	116	48280-97	110	48505-02	185	49384-15	522
47860-85	241	47862C10	244	48238-00	400	48278-77	113	48281-22	140	48505-03	185	49603-15	287
47860-86	244	47863-10	247	48239-00	400	48278-81	117	48282-21	140	48506-01	185	49603-20	287
47860-89	241	47863-11	247	48240-00	400	48278-82	117	48286-03	143	48506-02	185	49603-25	287
47860-95	241	47863-12	247	48241-14	408	48278-83	117	48286-08	143	48506-03	185	49603-30	287
47860-96	241	47863-13	247	48242-09	408	48278-84	117	48286-13	143	48507-38	186	49603-40	287
47860-97	241	47863-14	247	48244-04	408	48278-85	117	48286-62	139	48507-43	186	49603-50	287
47860-98	241	47863-15	247	48244-07	408	48278-87	113	48286-64	139	48507P38	186	49604-31	287
47860-99	241	47863-16	247	48245-10	408	48278-88	117	48286-67	109	48508-43	186	49604-36	287
47861-02	238	47863-17	247	48245-75	408	48278-89	117	48286-67	177	48509-33	186	49604-41	287
47861-03	238	47863-20	247	48247-10	407	48278-91	115	48286-68	400	48509-43	186	49605-46	287
47861-04	238	47863-21	247	48249-10	407	48278-92	115	48286-70	142	48509K43	186	49605-61	287
47861-05	238	47863-22	247	48249-12	407	48278-93	116	48287-18	407	48510-00	185	49605-71	287
47861-06	238	47863-23	247	48249-13	407	48278-94	113	48287-19	407	48511-02	187	49606-00	288
47861-07	238	47863-24	247	48250-10	407	48278-95	114	48288-02	139	48512-02	187	49606-01	288
47861-08	238	47863-25	247	48250-12	407	48278-96	114	48288-03	139	48513-02	187	49606-51	288
47861-09	238	47863-26	247	48251-03	407	48278-99	115	48288-05	139	48514-00	185	49607-15	289
47861-10	238	47865-23	246	48252-10	408	48280-02	109	48289-10	138	48516-07	187	49607-20	289

Cod.	pag.	Cod.	pag.	Cod.	pag.	Cod.	pag.	Cod.	pag.	Cod.	pag.	Cod.	pag.
49607-25	289	49657-31	284	49821-08	137	49850-75	550	49922-04	557	49975-25	565	66345-65	476
49607-30	289	49657-32	283	49823-00	142	49850-76	550	49922-06	557	49975-30	565	66345-74	476
49608-15	289	49657-33	283	49823-89	142	49851-10	560	49922-08	557	49975-35	565	66362-02	396
49608-20	289	49657-34	284	49823-99	142	49855-05	506	49922-09	558	49975U19	565	66374-00	307
49608-25	289	49657-35	284	49827-03	143	49855-10	506	49922-20	558	49975U22	565	66391-00	308
49608-30	289	49657-36	284	49827-77	142	49855-15	507	49922-21	558	49975U25	565	67303-64	307
49608-35	289	49657-37	283	49827-99	142	49856-04	506	49922-22	557	49975U30	565	XO1046	580
49609-12	289	49658-01	285	49829-11	141	49858-07	357	49922-23	557	49975U35	565		
49609-14	289	49658-02	285	49829-BA	579	49860-00	358	49923-00	348	49978-10	182		
49610-11	289	49701-00	150	49830-00	579	49863-15	156	49923-01	348	49978-13	182		
49610-14	289	49702-00	150	49830-02	579	49863-30	156	49923-02	348	49979-03	552		
49614-15	287	49703-00	153	49830-60	141	49863-50	156	49923-99	348	49986-00	151		
49614-20	287	49703-01	212	49830-AA	579	49863-AA	156	49924-21	349	49987-00	151		
49614-25	287	49705-00	149	49830-AB	579	49864-03	155	49924-31	349	49988-00	151		
49614-30	287	49709-03	149	49830-AC	579	49864-05	155	49924-36	349	49993-01	553		
49614-40	287	49710-00	150	49831-10	140	49864-20	155	49929R30	543	49993-02	553		
49614-50	287	49711-00	151	49832-02	140	49867-01	147	49929R45	543	49993-03	553		
49618-12	288	49712-00	149	49832-10	140	49867-02	147	49929R68	543	49993-11	554		
49618-15	288	49715-00	150	49832-80	579	49871-10	566	49929R87	543	49993-12	554		
49618-18	288	49716-00	150	49832-86	579	49871-20	566	49929W30	543	49993-13	554		
49626-00	286	49717-00	151	49832-88	579	49872-00	566	49929W45	543	49993-21	553		
49626-02	286	49719-00	153	49832-90	579	49875-06	178	49929W87	543	49993-22	553		
49627-22	286	49720-00	153	49832-96	579	49876-03	182	49931-00	542	49993-23	553		
49630-06	551	49721-03	153	49832-98	579	49879-37	146	49931-60	542	49995-04	511		
49634-00	289	49727-00	155	49833-00	487	49879-90	580	49931-64	542	49996-00	512		
49636-00	174	49728-00	151	49834-00	138	49879-91	580	49931-87	542	49996-01	512		
49655-02	286	49729-00	152	49834-01	579	49879-92	580	49931A00	542	49996-05	512		
49655-24	282	49730-00	153	49834-02	579	49879-93	580	49931B05	542	49997-12	560		
49655-27	286	49730-20	153	49835-00	138	49879-94	580	49931C04	542	49997-13	560		
49655-29	282	49731-10	154	49836-00	138	49880-10	152	49933-50	543	49998-20	561		
49655-31	282	49731-99	154	49837-05	136	49880-11	152	49934-04	544	49998-35	560		
49655-34	279	49733-00	153	49837-AA	580	49880-12	152	49934-06	544	49999-04	52		
49655-39	281	49734-00	153	49838-08	137	49880-13	152	49934-08	544	52550F63	572		
49655-41	281	49735-00	153	49838-98	137	49880-14	152	49934-14	544	52550F73	572		
49655-49	287	49739-00	177	49838-AB	580	49880-15	152	49934-16	544	52550F78	572		
49655-50	287	49741-07	566	49842-00	137	49880-17	152	49934-18	544	52550F80	572		
49655-67	282	49741-15	566	49843-05	145	49881-01	152	49940-01	556	52550F88	572		
49655-68	282	49750-00	138	49844-01	145	49881-02	152	49942-01	556	56345-AA	311		
49655-69	282	49752-00	142	49845-01	136	49881-11	152	49942-03	556	66303-01	306		
49655-70	284	49753-06	142	49846-05	507	49881-99	152	49943-01	555	66303-03	306		
49655-72	284	49753-09	142	49846-09	507	49883-00	150	49943-02	555	66303-06	306		
49655-73	282	49760-00	136	49846-15	561	49884-08	151	49944-01	555	66307-06	306		
49655-80	285	49771-00	156	49846-15	507	49885-02	149	49944-02	555	66307-09	306		
49655-81	285	49772-01	156	49847-08	507	49887-00	149	49945-05	559	66307-12	306		
49655-86	285	49773-05	155	49847-38	507	49887-02	150	49946-01	556	66313-03	306		
49655-89	286	49774-05	156	49850-03	553	49888-10	134	49947-08	559	66313-06	307		
49655-90	287	49775-05	156	49850-06	551	49888-20	134	49949-09	557	66318-19	308		
49655B91	285	49775-10	156	49850-10	551	49889-09	132	49949-19	551	66318-22	308		
49655G91	285	49776-15	156	49850-11	550	49889-12	132	49949-20	555	66320-28	476		
49655R70	284	49776-30	156	49850-13	549	49889-15	132	49953-02	552	66320-35	476		
49656B04	281	49777-50	156	49850-14	549	49892-40	544	49954-20	559	66320-40	476		
49656B06	281	49779-15	156	49850-18	549	49899-01	543	49954-21	559	66320-50	476		
49656B07	280	49779-30	156	49850-19	548	49899-91	543	49955-01	559	66320-65	476		
49656B08	280	49790-09	507	49850-20	547	49899-92	543	49956-01	558	66320-85	476		
49656B09	280	49801-04	547	49850-21	548	49899-93	543	49956-AA	580	66320-99	476		
49656B10	280	49801-06	547	49850-22	548	49899-94	543	49957-00	558	66324-40	476		
49656B12	280	49802-04	547	49850-23	548	49899-95	543	49958-00	558	66324-50	476		
49656B17	280	49802-06	547	49850-24	553	49899-AA	580	49959-00	558	66324-65	476		
49656B26	281	49803-02	547	49850-25	553	49907-01	554	49960-00	559	66324-85	476		
49656C04	281	49806-00	548	49850-26	553	49907-06	554	49971-25	182	66324-99	476		
49656C06	281	49809-00	552	49850-27	553	49907-AA	554	49971M25	182	66325-30	476		
49656C07	280	49811-00	147	49850-33	549	49911-19	555	49971P25	182	66325-35	476		
49656C08	280	49811-01	579	49850-36	550	49911-24	554	49971R00	182	66325-41	476		
49656C09	280	49811-02	579	49850-37	551	49911-30	555	49971R25	182	66325-46	476		
49656C10	280	49812-00	147	49850-41	550	49911-35	555	49972-30	182	66325-54	476		
49656C12	280	49812-01	579	49850-42	551	49911-45	555	49972M30	182	66325-85	476		
49656C17	280	49814-00	147	49850-43	551	49916-25	554	49972P30	182	66325-99	476		
49656C26	281	49814-01	579	49850-44	551	49916-35	554	49972R30	182	66326-30	476		
49657-03	281	49818-00	137	49850-61	549	49916-45	554	49974-25	565	66326-35	476		
49657-09	282	49818-AC	137	49850-63	552	49916-55	554	49974-30	566	66326-40	476		
49657-10	283	49818-AD	137	49850-65	548	49921-00	564	49974U25	565	66326-60	476		
49657-11	283	49818-AE	137	49850-70	551	49922-01	556	49974U30	566	66326-80	476		
49657-12	282	49818-AF	137	49850-71	549	49922-02	556	49975-19	565	66339-02	308		
49657-30	283	49820-05	136	49850-73	550	49922-03	557	49975-22	565	66345-55	476		

SALES CONDITIONS

CONDIZIONI DI VENDITA

LIEFERBEDINGUNGEN

CONDITIONS DE VENTE

CONDICIONES DE VENTA

ENG

General Sales Conditions

1. These General Conditions of Sale are applicable to any order forwarded by the customer to Sambonet Paderno Industrie S.p.A.
2. Sambonet Paderno Industrie S.p.A reserves the unquestionable right to modify these General Conditions at any time, by giving written notice to the customer.
3. Novara will be the only place of venue and jurisdiction should any dispute, controversy or claim occurs. Italian Laws will be applied exclusively.
4. The personal data provided by the customer will be processed in compliance with EU Regulation no. 679/2016 and Legislative Decree n. 196/2003.

Offers/Orders

1. All orders are subject to approval and acceptance by Sambonet Paderno Industrie S.p.A.
2. Minimum order € 100.00 net.
3. Any offer forwarded by Sambonet Paderno Industrie S.p.A will not be binding.
4. The written acceptance of any offer, or the order confirmation (according to the sales conditions included in it), constitutes a valid purchase order in accordance with the general sales terms & conditions, for all the purposes thereof.
5. Standard packaging is included in the price.
6. Customers who intend to avail themselves of the non-taxability stated in art. 8, paragraph 1, letter c), of the D.P.R. no. 633/1972 (declaration of intent), must communicate it in writing upon sending the order, to allow the completion of the necessary administrative procedures.

Ownership & Payment Terms

1. All goods remain the sole property of the Sambonet Paderno Industrie S.p.A. until payment has been made in full.
2. Title to the ownership of any delivered good shall be transferred to the client upon full payment of the price set forth in the invoice. Payment becomes due within the payment term agreed upon by the parties. Should any amount to be paid by the client become overdue, the client shall pay a late payment interest pursuant to art. 5 D.LGS. 231/2002, as subsequently amended pursuant D.LGS. 192/2012, plus an 8% interest rate.

Returns/Complaints

1. Goods must be inspected at the time of delivery.
2. Should any good be damaged or defected, the waybill shall be signed with reserve, specifying the relevant reason (pictures of the good displaying the batch number, the courier and a description of the defect must be presented).
3. Product returns must be made within 15 days of invoice date, subject to the following conditions:
 - a) claims and complaints must be made through the guided procedure available on our website, www.agenti.sambonet.it, under the user section;
 - b) Goods are delivered ex works - at our premises in Orfengo;
 - c) in case of customer liability, Sambonet Paderno Industrie S.p.A. will charge 15% of the net value of the goods, with a minimum of € 25.00 for handling charges;
 - d) in case goods are returned due to our fault, Sambonet Paderno Industrie S.p.A. will replace them free of charge;
 - e) client will be responsible for all shipping costs for products purchased out of warranty that need to be returned for repairs;
 - f) customized (not included in our catalogue), Tailor Made engraved, with extra personalization and discontinued items cannot be returned.

Order Cancellation

1. Cancellation is not allowed in case of discontinued, custom designed, and non-stock items.
2. Catalogue items can be cancelled only if the purchase order has not yet been confirmed.

Delivery Terms – Group A

Austria, Germany, Netherlands, Belgium, Luxembourg, France, UK:

1. Goods are delivered at client's place:
 - a) with a charge of € 15.00 for orders with a net value between € 100.00 and € 350.00.
 - b) free of charge for orders with a net value over € 350.00.
2. Above delivery terms are valid only for shipments executed through our fixed forwarding agent.

Delivery Terms – Group B

Spain, Portugal, Poland, Czech Republic, Slovakia, Hungary, Romania, Slovenia, Croatia, Bulgaria, Denmark, Norway:

1. Goods are delivered at client's place:
 - a) with a charge of € 30.00 for orders with a net value between € 100.00 and € 600.00.
 - b) free of charge for orders with a net value over € 600.00.
2. Above delivery terms are valid only for shipments executed through our fixed forwarding agent.

Delivery Terms – Group C

Greece, Ireland, Latvia, Lithuania, Estonia, Sweden, Finland:

1. Goods are delivered at client's place:
 - a) with a charge of € 50.00 for orders with a net value between € 100.00 and € 1,000.00.
 - b) free of charge for orders with a net value over € 1,000.00.
2. Above delivery terms are valid only for shipments executed through our fixed forwarding agent.

Delivery Terms – Group D

EU and Extra-EU countries not specified in the previous paragraphs:

1. Goods are delivered ex works.

Personalisations (The costs indicated are net)

1. Sambonet Paderno Industrie S.p.A. makes customizations and special executions at the customer's request under the following conditions:
 - a) advance payment of 30% on the value of the order;
 - b) delivery to be agreed after approval of the executive design and/or the sample;
 - c) Sambonet Paderno Industrie S.p.A. reserves the right to apply a tolerance in quantity of +/- 10% (rounded up) for each item ordered;
 - d) Sambonet Paderno Industrie S.p.A. shall provide the Customer with a form indicating all the necessary parameters (design, position, dimensions, etc.) and shall proceed with the supply only upon receipt of the same signed for acceptance.
2. Sawing of fruit knife blades: if not standard, € 0.65 per piece will be charged.
3. Pantograph/Laser engraving:
 - a) plant cost: € 70.00.
 - b) engraving cost: cutlery € 0.50 per piece – holloware € 1.00 per piece.
 - c) minimum quantities: cutlery 100 pcs – holloware 10 pcs.
4. Stamping:
 - a) die costs: € 300.00 for the first die - additional dies € 150.00 each;
 - b) stamping costs: cutlery € 0.50 per piece - holloware will be quoted upon request;
 - c) minimum quantities:
 - first order: cutlery 1,000 pieces per item - hollow handle knives 800 pieces per item;
 - for further orders: cutlery 100 pieces per item - hollow handle knives 800 pieces per item.

Sambonet Tailor Made personalizations (The costs indicated are net)

1. Type of standard Tailor-Made engravings:
 - a) On the front terminal: one of the standard logos, or the monogram (two letters) using one of the standard characters;
 - b) On the rear terminal: the date in the standard format, using one of the standard characters;
2. Tailor-Made engraving cost:
 - a) € 19.90 for engravings on the front terminal;
 - b) € 19.90 for engravings on the rear terminal;
 - c) € 39.80 for engraving on both the front and rear terminals.
3. Minimum purchase order for Tailor Made loose items:
 - a) 6 pcs for nickel-silver items, multiples of 6 pcs;
 - b) 12 pcs for all other items, multiples of 12 pcs.
4. Application of the Tailor-Made engraving cost on the single purchase order:
 - a) A single cost per type of engraving, as set out in point 2;
 - b) A single cost regardless of the number of pcs, if higher than the minimum purchase indicated in point 3;
 - c) One cost regardless of the number of pcs up to 150 pcs.
 - d) Above 150 pcs and at multiples of 150 pcs the cost of engraving will be applied again.

Special conditions for personalisations

1. The Company reserves the right not to carry out the customization if it considers it not technically executable.
2. Customized orders and special executions cannot be cancelled.
3. Customized products cannot be returned for replacement.
4. The costs of customised order preparation (such as labelling, packaging, palletization and/or any other non-standard requirements) will be charged to the Customer. For conditions, costs, and specific details, please refer to the company document "Sales Service Charter".

Marketing

1. The goods are intended for marketing in the Country where the customer is based. If the goods are sold in a different Country, the client shall undertake to verify the regulations applicable to the goods in such Country, including customs and import rules, as well as the risk of disputes by third parties for any reason whatsoever. It being understood that the client shall hold Sambonet Paderno Industrie S.p.A. freehand harmless of any claim and/or legal action from third parties arising by the sale of the goods in such different Country.
2. Sambonet Paderno Industrie S.p.A. does not provide any guarantee regarding possible infringement of intellectual property rights of third parties, in particular in the event of resale of the goods over the internet.
3. It is prohibited to publish prices lower than the price lists in force on websites without authentication.

Retention of title and payment terms

1. Any complaints shall not in any case have the effect of deferring or suspending payments.
2. Any payment delays shall therefore render the Customer a debtor by law to Sambonet Paderno Industrie S.p.A. of a lump sum indemnity for reminder costs of € 40.00. If the reminder costs exceed the amount, Sambonet Paderno Industrie S.p.A. will have the right to claim a further indemnity.
3. In the event of non-payment of all or part of the invoice, or of any deterioration in the Customer's financial situation, Sambonet Paderno Industrie S.p.A. will also have the right to:
 - a) suspend or cancel the orders and deliveries in progress;
 - b) request advance payment for further orders and/or payment guarantees.

Delivery, Force Majeure, and Excessive Onerousness

1. The delivery deadlines are indicated as accurately as possible, but they depend upon the procurement and transportation conditions of Sambonet Paderno Industrie S.p.A., which undertakes to apply the utmost diligence to respect the deliveries, subject to causes of force majeure.
2. If the planned delivery deadlines are exceeded, Sambonet Paderno Industrie S.p.A. shall not be required to pay any penalty, damages compensation or interest.
3. Any change to the order will lead to a consequent change to the delivery date.
4. Sambonet Paderno Industrie S.p.A. will keep the Customer informed of any delay. In any case, the delivery within the deadlines may only be made if the Customer has precisely fulfilled all its obligations towards Sambonet Paderno Industrie S.p.A., whatever the cause.
5. Sambonet Paderno Industrie S.p.A. will not be held responsible if the delayed or non-performance of the contractual obligations depends on causes of force majeure, to the extent that the interested party demonstrates: a) that such impediment is beyond its reasonable control; b) that the impediment could not reasonably have been foreseen at the time of conclusion of the contract; and c) that the effects of the impediment could not reasonably have been avoided or overcome. In the absence of evidence to the contrary, force majeure events are considered, but not limited to, war, riot, trade restrictions, embargo, fire, destruction of equipment, strikes, act of legal authority, compliance with any law or government order, plague, epidemic, pandemic, natural disaster, or extreme natural event. In such cases, Sambonet Paderno Industrie S.p.A. may suspend the fulfillment of its contractual obligations, giving immediate written notice to the other party and the deadline for the execution of the supply may be extended for a period equal to the duration of the event. Unless otherwise agreed in writing, once the period of suspension has elapsed, the contract will be considered terminated without further notice.
6. Sambonet Paderno Industrie S.p.A. may also terminate the contract if the performance of the service is made objectively too onerous by an unforeseeable circumstance beyond its control.
7. It is, moreover, agreed between the parties that if the Customer does not take possession of the ordered products under the established conditions, Sambonet Paderno Industrie S.p.A. will invoice to the Customer:
 - a) any additional transportation and/or storage cost;
 - b) custody costs equivalent to 5% of the order amount, excluding taxes, for each month of delay.

Important notice

1. The perception of colour may be subjective, in function of geometries, dimensions, finishes, and lighting in the environment. The products subject to PVD processing may manifest slight chromatic variations or diversities between different models, series, or batches of the same product. These variations are acceptable if within the established tolerance limits, which are strictly monitored.
2. Errors may occur during the printing stage. Sambonet Paderno Industrie S.p.A. reserves the right to correct printing or calculation errors.
3. The pictures illustrated, and data are representatives. Sambonet Paderno Industrie S.p.A. reserves the right to alter at any time the specifications stated without notice.
4. The shapes of cutlery illustrated in this publication are representatives and are not to be considered as the real shape.

Condizioni Generali di Vendita

1. Le presenti Condizioni Generali di Vendita sono applicabili a qualsiasi ordine inoltrato dal Cliente a Sambonet Paderno Industrie S.p.A.
2. Sambonet Paderno Industrie S.p.A. si riserva il diritto insindacabile di modificare in qualunque momento le presenti Condizioni Generali, dandone comunicazione per iscritto al Cliente.
3. Per ogni contestazione o controversia è applicabile la legge Italiana ed è esclusivamente competente il Foro di Novara.
4. I dati personali forniti dal Cliente saranno oggetto di trattamento nel rispetto del Regolamento UE n. 679/2016 e del D.Lgs n. 196/2003

Offerte/Ordini

1. Gli ordini sono soggetti ad approvazione di Sambonet Paderno Industrie S.p.A.
2. Ordine minimo € 100,00 netto merce.
3. Le offerte di Sambonet Paderno Industrie S.p.A. sono libere e non vincolanti all'ordine.
4. Con l'accettazione dell'offerta in forma scritta o della conferma d'ordine (con le modalità in essa contenute), si genera a tutti gli effetti un ordine che comporta l'esecuzione di un contratto conforme alle Condizioni Generali di Vendita.
5. Imballaggio standard gratuito.
6. I clienti che intendono avvalersi della non imponibilità di cui all'art. 8, comma 1, lett. c), del D.P.R. n. 633/1972 (dichiarazione di intento), dovranno comunicarlo al momento dell'invio dell'ordine, onde poter permettere l'espletamento delle necessarie pratiche amministrative.

Diritto di Proprietà e Condizioni di Pagamento

1. La merce fornita rimane di proprietà di Sambonet Paderno Industrie S.p.A. fino all'integrale pagamento della fattura da parte del cliente.
2. Il pagamento della fattura è dovuto entro il termine di pagamento preventivamente concordato tra le parti. Allo scadere di tale termine, saranno dovuti gli interessi di mora al saggio di cui all'art.5 D.LGS. 231/2002 e succ. modifiche come da D.LGS. 192/2012, maggiorato dell'8%.

Resi/Reclami

1. La merce deve essere controllata al ricevimento.
2. In caso di colli difettosi/danneggiati, il documento di trasporto dovrà essere firmato con riserva, specificando i motivi (vale come prova la foto del collo con evidenza del segnacollo e nastro del corriere e descrizione del difetto).
3. I reclami saranno accettati entro 15 giorni dalla data fattura, termine ultimo non negoziabile, alle seguenti condizioni:
 - a) la segnalazione di reclamo/richesta di reso merce deve essere fatta attraverso la procedura guidata all'indirizzo www.agenti.sambonet.it nell'area utente;
 - b) la merce dovrà essere resa franco nostra fabbrica;
 - c) In caso di responsabilità del cliente, Sambonet Paderno Industrie S.p.A. provvederà all'addebito del 15% del prezzo netto, con un minimo di € 25,00, per costi di gestione;
 - d) in caso di accertata responsabilità di Sambonet Paderno Industrie S.p.A., la merce verrà sostituita, e resa franco domicilio cliente;
 - e) per prodotti resi per riparazione non in garanzia, le spese di spedizione e spedizione, sono a carico del cliente;
 - f) Non saranno accettati resi per articoli speciali (non a catalogo), incisi Tailor Made, con altre personalizzazioni o fuori produzione.

Annullamento dell'ordine

1. Per i prodotti fuori catalogo, personalizzati o speciali NON è possibile annullare l'ordine.
2. Per i prodotti a catalogo, l'annullamento è possibile solo se l'ordine non è ancora stato confermato.

Condizioni di Resa Italia

1. La merce è resa franco domicilio Cliente tramite corriere convenzionato con Sambonet Paderno Industrie S.p.A.:
 - a) con addebito forfettario di € 15,00 (spese di gestione ordine) per ordini da € 100,00 a € 350,00 netto merce;
 - b) senza alcun addebito per ordini superiori a € 350,00 netto merce.
2. Qualora il Cliente richieda che le spedizioni vengano effettuate tramite Suo corriere di fiducia, le merci verranno inoltrate automaticamente in franco fabbrica:
 - a) con addebito forfettario di € 15,00 (spese di gestione ordine) per ordini da € 100,00 a € 350,00 netto merce;
 - b) senza alcun addebito per ordini superiori a € 350,00 netto merce.

Condizioni di Resa – Gruppo A

Austria, Germania, Olanda, Belgio, Lussemburgo, Francia, UK;

1. La merce è resa franco domicilio Cliente:
 - a) con addebito di € 15,00 per ordini da € 100,00 a € 350,00 netto merce;
 - b) senza alcun addebito per ordini superiori a € 350,00 netto merce.
2. Le condizioni sopra indicate sono valide solo per spedizioni tramite corriere convenzionato con Sambonet Paderno Industrie S.p.A.

Condizioni di Resa – Gruppo B

Spagna, Portogallo, Polonia, Repubblica Ceca, Slovacchia, Ungheria, Romania, Slovenia, Croazia, Bulgaria, Danimarca, Norvegia;

1. La merce è resa franco domicilio Cliente:
 - a) con addebito di € 30,00 per ordini da € 100,00 a € 600,00 netto merce;
 - b) senza alcun addebito per ordini superiori a € 600,00 netto merce.
2. Le condizioni sopra indicate sono valide solo per spedizioni tramite corriere convenzionato con Sambonet Paderno Industrie S.p.A.

Condizioni di Resa – Gruppo C

Grecia, Irlanda, Lettonia, Lituania, Estonia, Svezia, Finlandia;

1. La merce è resa franco domicilio Cliente:
 - a) con addebito di € 50,00 per ordini da € 100,00 a € 1.000,00 netto merce;
 - b) senza alcun addebito per ordini superiori a € 1.000,00 netto merce.
2. Le condizioni sopra indicate sono valide solo per spedizioni tramite corriere convenzionato con Sambonet Paderno Industrie S.p.A.

Condizioni di Resa – Gruppo D

Nazioni UE ed Extra-UE non specificate nei paragrafi precedenti;

1. La merce è resa franco fabbrica.

Personalizzazioni (I costi indicati sono da intendersi netti)

1. Sambonet Paderno Industrie S.p.A. effettua su richiesta del Cliente personalizzazioni ed esecuzioni particolari alle seguenti condizioni:
 - a) versamento di acconto del 30% sul valore dell'ordine;
 - b) consegna da convenire dopo l'approvazione disegno esecutivo e/o campione;
 - c) Sambonet Paderno Industrie S.p.A. si riserva la facoltà di applicare, per ogni singolo articolo, una tolleranza pari a +/- 10%, con arrotondamento all'unità superiore, nella spedizione dei quantitativi ordinati;
 - d) Sambonet Paderno Industrie S.p.A. provvederà a fornire al Cliente una scheda con l'indicazione di tutti i parametri necessari (disegno, posizione, dimensioni, ecc.) e procederà alla fornitura solo al ricevimento della stessa firmata per accettazione.
2. Seghettatura lame coltelli frutta: ove non prevista di serie, con addebito di € 0,65 al pezzo.

3. Incisione al Pantografo/Laser:
 - a) costo impianto: € 70,00;
 - b) costo incisione: posateria € 0,50 al pezzo - vasellame, incisione ove possibile, € 1,00 al pezzo;
 - c) quantità minime: posateria 100 pezzi per articolo - vasellame 10 pezzi per articolo.
4. Punzonatura:
 - a) costo punzoni: il primo punzone € 300,00 - i successivi € 150,00 cad.;
 - b) costo punzonatura: posateria € 0,50 al pezzo - vasellame preventivo su richiesta;
 - c) quantità minime:
 - nuovi impianti: posateria 1.000 pezzi per articolo - coltelli manico cavo 800 pezzi per articolo;
 - riordini: posateria 100 pezzi per articolo - coltelli manico cavo 800 pezzi per articolo.

Personalizzazioni Sambonet Tailor Made (I costi indicati sono da intendersi netti)

1. Tipologia di incisioni Tailor Made standard:
 - a) Sul terminale frontale: uno dei loghi standard, oppure il monogramma (due lettere) utilizzando uno dei caratteri standard;
 - b) Sul terminale posteriore: la data in formato standard, utilizzando uno dei caratteri standard;
2. Costo di incisione Tailor Made:
 - a) € 19,90 per incisioni sul terminale frontale;
 - b) € 19,90 per incisioni sul terminale posteriore;
 - c) € 39,80 per incisioni sul terminale frontale e sul terminale posteriore.
3. Ordine minimo di acquisto per articoli sfusi Tailor Made:
 - a) 6 pz per le referenze realizzate in alpacca, a multipli di 6 pz;
 - b) 12 pz per tutte le altre referenze, a multipli di 12 pz;
4. Applicazione del costo di incisione Tailor Made sul singolo ordine di acquisto:
 - a) Un solo costo per ogni tipologia di incisione - indicate al punto 2;
 - b) Un solo costo a prescindere dal numero di referenze - se superiori al minimo di acquisto indicato al punto 3;
 - c) Un solo costo a prescindere dal numero di pz fino a 150 pz.
 - d) Oltre i 150 pz e a multipli di 150 pz verrà nuovamente applicato il costo di incisione.

Condizioni speciali per le personalizzazioni

1. L'Azienda si riserva il diritto di non eseguire la personalizzazione qualora tecnicamente non eseguibile.
2. Ordini personalizzati e/o esecuzioni particolari non possono essere annullati.
3. I prodotti personalizzati non possono essere resi per sostituzione.
4. I costi di preparazione personalizzata dell'ordine (quali etichettatura, confezionamento, imballaggio, palletizzazione e/o ogni altra richiesta fuori dallo standard) saranno a carico del Cliente. Per condizioni, costi e dettagli specifici, fare riferimento al documento aziendale denominato "Carta dei servizi".
5. Quantità minime per nuovi impianti: 300 pezzi per articolo; per riordini: 100 pezzi per articolo.

Commercializzazione

1. La merce è destinata alla commercializzazione nel Paese in cui ha sede il Cliente. Qualora la merce sia commercializzata in un Paese differente, sarà onere del Cliente verificare le normative applicabili in tale Paese incluse le normative doganali e di importazione, nonché il rischio di contestazioni da parte di terzi a qualunque titolo, restando inteso che Sambonet Paderno Industrie S.p.A. sarà manlevata e tenuta indenne dal Cliente per quanto causato dalla vendita della merce in tale diverso Paese.
2. Sambonet Paderno Industrie S.p.A. non fornisce alcuna garanzia in ordine a possibili contestazioni di violazione di diritti di proprietà industriale ed intellettuale di terzi, in particolare nell'ipotesi di rivendita della merce a mezzo Internet.
3. È vietato pubblicare prezzi inferiori ai listini vigenti in siti web senza autenticazione.

Riserva di proprietà e condizioni di pagamento

1. Eventuali reclami non potranno in alcun caso avere come effetto il differimento o la sospensione dei pagamenti.
2. Il Cliente in situazioni di ritardo di pagamento sarà peraltro debitore di diritto, nei confronti di Sambonet Paderno Industrie S.p.A. di un indennizzo forfettario per spese di sollecito pari a € 40,00. Qualora le spese di sollecito siano superiori al suddetto importo, Sambonet Paderno Industrie S.p.A. avrà il diritto di richiedere un ulteriore indennizzo.
3. In caso di mancato pagamento di tutta o parte della fattura, o di aggravio della situazione finanziaria del Cliente, Sambonet Paderno Industrie S.p.A. avrà anche la facoltà di:
 - a) sospendere o annullare gli ordini e le consegne in corso;
 - b) esigere un pagamento anticipato per gli ulteriori ordini e/o garanzie di pagamento.

Consegna, Forza maggiore ed Eccessiva Onerosità Sopravvenuta

1. Le scadenze di consegna sono indicate il più esattamente possibile, ma dipendono dalle condizioni di approvvigionamento e trasporto di Sambonet Paderno Industrie S.p.A., la quale si impegna a porre la massima diligenza ai fini del rispetto delle consegne salvo cause di forza maggiore.
2. Il superamento dei tempi di consegna previsti, non comporterà per Sambonet Paderno Industrie S.p.A. alcun versamento di penalità, né sarà oggetto di richieste per risarcimenti danni e interessi.
3. Qualsiasi modifica di ordine darà luogo a una conseguente modifica della data di consegna.
4. Sambonet Paderno Industrie S.p.A. terrà il Cliente tempestivamente informato di qualsiasi ritardo. In ogni caso, la consegna entro i termini potrà essere effettuata soltanto se il Cliente avrà puntualmente ottemperato a tutti i suoi obblighi nei confronti di Sambonet Paderno Industrie S.p.A., qualsiasi sia la causa.
5. Sambonet Paderno Industrie S.p.A. non sarà ritenuta responsabile qualora la ritardata o mancata esecuzione delle obbligazioni contrattuali dipenda da cause di Forza Maggiore, nella misura in cui la parte interessata dimostra: a) che tale impedimento è al di fuori del suo ragionevole controllo; b) che non poteva ragionevolmente essere previsto al momento della conclusione del contratto; e c) che gli effetti dell'impedimento non avrebbero potuto ragionevolmente essere evitati o superati. In assenza di prove contrarie, si considerano eventi di forza maggiore, a titolo esemplificativo, guerra, rivolta, restrizioni commerciali, embargo, incendio, distruzione di attrezzature, scioperi, atto di autorità legale, rispetto di qualsiasi legge o ordine governativo, peste, epidemia, pandemia, calamità naturale o evento naturale estremo. In tali casi, Sambonet Paderno Industrie S.p.A. potrà sospendere l'adempimento dei suoi obblighi contrattuali, dandone immediato avviso per iscritto all'altra parte ed il termine per l'esecuzione della fornitura potrà essere prorogato per un periodo uguale alla durata dell'evento. Salvo diverso accordo scritto, decorso inutilmente il periodo di sospensione, il contratto si intenderà risolto senza ulteriore avviso.
6. Sambonet Paderno Industrie S.p.A. potrà, altresì, risolvere il contratto qualora l'esecuzione della prestazione sia resa oggettivamente troppo onerosa da una circostanza imprevedibile indipendente dalla sua volontà.
7. Viene peraltro convenuto tra le parti che se il Cliente non prenderà possesso dei prodotti ordinati alle condizioni stabilite, Sambonet Paderno Industrie S.p.A. fatturerà al Cliente:
 - a) qualsiasi ulteriore spesa di trasporto e/o giacenza;
 - b) spese di custodia equivalenti al 5% dell'importo dell'ordine, tasse escluse, per ogni mese di ritardo.

Avvertenze importanti

1. La percezione del colore può risultare soggettiva in funzione di geometria, dimensioni, finiture e illuminazione dell'ambiente. I prodotti sottoposti a lavorazione PVD potrebbero essere soggetti a piccole variazioni cromatiche o discontinuità tra diversi modelli, tra diverse referenze o tra partite diverse dello stesso prodotto. Tali variazioni sono comprese entro limiti di tolleranza prestabiliti e strettamente monitorati.
2. In fase di stampa sono possibili errori e/o omissioni. Sambonet Paderno Industrie S.p.A. si riserva il diritto di rettifica di eventuali errori di stampa o calcolo.
3. Le immagini, le caratteristiche e le misure espresse sono indicative e soggette a variazioni senza preavviso.
4. Le sagome delle posate illustrate di questa pubblicazione sono puramente indicative e non si riferiscono alle sagome reali.

DEU

Allgemeine Verkaufsbedingungen

1. Diese allgemeinen Verkaufsbedingungen gelten für alle Bestellungen, die vom Kunden an Sambonet Paderno Industrie S.p.A. gesandt werden
2. Sambonet Paderno Industrie S.p.A. behält sich das unbestreitbare Recht vor, diese Allgemeinen Geschäftsbedingungen jederzeit durch schriftliche Mitteilung an den Kunden zu ändern.
3. Im Streitfall ist Erfüllungsort Novara; Gerichtsstand ist Novara. Es gilt ausschließlich das Rechts der Italienischen Republik.
4. Die vom Kunden bereitgestellten personenbezogenen Daten werden in Übereinstimmung mit der EU-Verordnung Nr. 679/2016 und Gesetzesdekret n. 196/2003.

Angebote/Bestellungen

1. Bestellungen sind erst nach Bestätigung durch Sambonet Paderno Industrie S.p.A. gültig.
2. Mindestwarenbestellwert € 100,00 netto.
3. Angebote von Sambonet Paderno Industrie S.p.A. sind freibleibend.
4. Mit der schriftlichen Annahme des Angebots oder der Auftragsbestätigung (mit allen enthaltenen Bedingungen) wird eine in jeder Hinsicht wirksame Bestellung aufgegeben, die mit der Ausführung eines Vertrags gemäß den allgemeinen Verkaufsbedingungen verbunden ist.
5. Kostenlose Standardverpackung.
6. Kunden, die sich der Nichtbesteuerung gem. 8, Absatz 1, lett. c), der D.P.R. n. 633/1972 (Absichtserklärung) bedienen, müssen diese bei der Zusendung der Bestellung mitteilen, um die Erledigung der erforderlichen Verwaltungsverfahren zu ermöglichen.

Eigentumsrecht und Zahlungsbedingungen

1. Die gelieferte Ware bleibt bis zur vollständigen Bezahlung der Rechnung durch den Kunden Eigentum der Sambonet Paderno Industrie S.p.A.
2. Die Bezahlung der Rechnung muss innerhalb der zwischen den Parteien zuvor vereinbarten Zahlungsfrist erfolgen. Nach Ablauf dieser Frist werden Verzugszinsen in der in Art. 5 der [italienischen gesetzesvertretenden Verordnung] D. Lgs. 231/2002 (in der durch D. Lgs. 192/2012 geänderten Fassung) vorgesehenen Höhe zuzüglich 8 % fällig.

Rückgaben/Reklamationen

1. Die Ware ist bei Erhalt zu kontrollieren.
 2. Sollten Pakete defekt/beschädigt sein, so ist das Transportdokument unter Vorbehalt und mit Angabe der Gründe (z. B. ein Foto der Ware, auf der die Kennzeichnung der Ware und die Spedition erkennbar sind, und eine Beschreibung des Defekts) zu unterschreiben.
- Reklamationen werden innerhalb von 15 Tagen nach Rechnungsdatum als letzte nicht verhandelbare Frist unter folgenden Bedingungen angenommen:
- a) Die Reklamation/der Antrag auf Rücknahme der Ware erfolgt über das angeleitete Verfahren im Benutzerbereich der Website www.agenti.sambonet.it;
 - b) Die Lieferung erfolgt frei unserem Werk;
 - c) Liegt die Verantwortung für die Rückgabe beim Kunden, Sambonet Paderno Industrie S.p.A. stellt 15% des Nettopreises, jedoch mindestens € 25,00 als Bearbeitungskosten in Rechnung;
 - d) Liegt die Verantwortung nachgewiesenermaßen bei Sambonet Paderno Industrie S.p.A., wird die Ware ersetzt und dem Kunden frei Haus zugestellt;
 - e) Im Falle von Produkten, die zur Reparatur zurückgegeben werden und keiner Gewährleistung unterliegen, gehen die Kosten für Zu- und Rücksendung zu Lasten des Kunden;
 - f) Nicht angenommen werden Rücksendungen von Sonderartikeln (nicht im Katalog), kundenindividuellen Artikeln und Artikeln, deren Produktion eingestellt wurde.

Stornierung der Bestellung

1. Bestellungen von Produkten, die nicht im Katalog enthalten oder die kundenindividuell gefertigt sind, oder Bestellungen von Sonderartikeln können NICHT storniert werden.
2. Bei Produkten aus dem Katalog ist eine Stornierung nur möglich, wenn die Bestellung noch nicht bestätigt wurde.

Lieferbedingungen – Gruppe A

Österreich, Deutschland, Holland, Belgien, Luxemburg, Frankreich, Großbritannien:

1. Die Lieferung zum Kunden erfolgt frei Haus, wobei:
 - a) bei einem Warenbestellwert zwischen € 100,00 und € 350,00 netto eine Pauschale von € 15,00 in Rechnung gestellt wird;
 - b) bei einem Warenbestellwert von über € 350,00 netto keine Versandkosten in Rechnung gestellt werden.
2. Die vorstehenden Bedingungen gelten nur für den Versand mit dem Vertragsspediteur von Sambonet Paderno Industrie S.p.A.

Lieferbedingungen – Gruppe B

Spanien, Portugal, Polen, Tschechische Republik, Slowakei, Ungarn, Rumänien, Slowenien, Kroatien, Bulgarien, Dänemark, Norwegen:

1. Die Lieferung zum Kunden erfolgt frei Haus, wobei:
 - a) bei einem Warenbestellwert zwischen € 100,00 und € 600,00 netto eine Pauschale von € 30,00 in Rechnung gestellt wird;
 - b) bei einem Warenbestellwert von über € 600,00 netto keine Versandkosten in Rechnung gestellt werden.
2. Die vorstehenden Bedingungen gelten nur für den Versand mit dem Vertragsspediteur von Sambonet Paderno Industrie S.p.A.

Lieferbedingungen – Gruppe C

Griechenland, Irland, Lettland, Litauen, Estland, Schweden, Finnland:

1. Die Lieferung zum Kunden erfolgt frei Haus, wobei:
 - a) bei einem Warenbestellwert zwischen € 100,00 und € 1.000,00 netto eine Pauschale von € 50,00 in Rechnung gestellt wird;
 - b) bei einem Warenbestellwert von über € 1.000,00 netto keine Versandkosten in Rechnung gestellt werden.
2. Die vorstehenden Bedingungen gelten nur für den Versand mit dem Vertragsspediteur von Sambonet Paderno Industrie S.p.A.

Lieferbedingungen – Gruppe D

EU- und Nicht-EU-Länder, die in den vorherigen Absätzen nicht aufgeführt sind:

1. Die Lieferung erfolgt frei Werk.

Kundenindividuelle Anfertigungen (die angegebenen Kosten verstehen sich als Nettobeträge)

1. Auf Wunsch des Kunden stellt Sambonet Paderno Industrie S.p.A. kundenindividuelle und Sonderanfertigungen her. Es gelten die folgenden Bedingungen:
 - a) Es wird eine Anzahlung in Höhe von 30 % des Bestellwertes geleistet;
 - b) Die Lieferung wird nach der Freigabe der endgültigen Gestaltung und/oder des Musters vereinbart;
 - c) Sambonet Paderno Industrie S.p.A. behält sich in Bezug auf den Versand der bestellten Mengen für jeden einzelnen Artikel einen Toleranzwert von +/- 10 % mit Aufrundung auf die nächsthöhere Einheit vor;
 - d) Sambonet Paderno Industrie S.p.A. legt dem Kunden ein Beschreibungsblatt mit allen erforderlichen Parametern (Zeichnung, Platzierung, Abmessungen usw.) vor. Die Lieferung erfolgt erst, nachdem der Kunde dieses zum Zeichen der Annahme unterschrieben und zurückgesendet hat.
2. Wellenschliff Obstmesser, wenn nicht serienmäßig vorgesehen, Aufpreis von € 0,65 pro Stück.
3. Gravur mit Pantografen/Laser
 - a) Einrichtungskosten: € 70,00;
 - b) Gravur Kosten: Besteck € 0,50 pro Stück – Geschirr, sofern Gravur möglich, € 1,00 pro Stück;
 - c) Mindestmengen: Besteck 100 Stück je Artikel – Geschirr 10 Stück je Artikel.
4. Stanzungen:
 - a) Punzen: erste Punze € 300,00 – jede weitere € 150,00;
 - b) Stanzkosten: Besteck € 0,50 pro Stück – Geschirr: bitte Kostenvoranschlag anfordern;
 - c) Mindestmengen:
 - Erstbestellung: Besteck 1.000 Stück je Artikel – Messer mit Hohlheftgriff 800 Stück je Artikel;
 - Folgebestellungen: Besteck 100 Stück je Artikel – Messer mit Hohlheftgriff 800 Stück je Artikel.

Personalisierungen Sambonet Tailor Made (die angegebenen Beträge sind Nettobeträge)

1. Arten Standardgravuren Tailor-Made:
 - a) Auf dem vorderen Ende des Besteckgriffs: eines der Standardlogos, oder das Monogramm (zwei Buchstaben) mit Standardschriftarten;
 - b) Auf dem hinteren Ende des Besteckgriffs: Datum im Standardformat, mit einer Standardschriftart;
2. Kosten der Gravur Tailor-Made:
 - a) € 19,90 für Gravuren auf dem Ende des Besteckgriffs / Vorderseite;
 - b) € 19,90 für Gravuren auf dem Ende des Besteckgriffs / Hinterseite;
 - c) € 39,80 für Gravuren auf dem Ende des Besteckgriffs / Vorder- und Hinterseite.
3. Mindestbestellung für lose Artikel Tailor-Made:
 - a) 6 St. für die Bezugsprofile in Alpacca, in Vielfachstückelungen von 6 St.;
 - b) 12 St. für alle anderen Bezugsprofile, in Vielfachstückelungen von 12 St.;
4. Anwendung der Preise für die Gravur Tailor-Made auf die einzelne Bestellung:
 - a) Nur einmalige Zahlung für jede Art von Gravur – wie in Punkt 2 angeführt;
 - b) Nur einmalige Zahlung unabhängig von der Zahl der Artikel – bei Überschreitung der Mindestbestellung wie in Punkt 3 angeführt;
 - c) Nur einmalige Zahlung unabhängig von der Stückzahl bis zu 150 St.
 - d) bei mehr als 150 St. und Vielfachen von 150 St. werden die Kosten für die Gravur erneut veranschlagt.

Sonderkonditionen für Personalisierungen

1. Die Firma behält sich das Recht vor die Personalisierung nicht auszuführen, wenn diese technisch nicht durchführbar ist.
2. Bestellungen von kundenindividuellen und/oder nicht standardmäßigen Sonderanfertigungen können nicht storniert werden.
3. Kundenindividuell gefertigte Artikel können nicht umgetauscht werden.
4. Die Kosten für kundenspezifische Auftragsvorbereitung (wie Etikettierung, Verpackung, Palettierung und/oder andere nicht standardisierte Anforderungen) werden dem Kunden in Rechnung gestellt. Die Bedingungen, Kosten und spezifischen Einzelheiten sind dem Unternehmensdokument "Sales Service Charter" zu entnehmen.

Vertrieb

1. Die Ware ist für die Vermarktung in dem Land, in dem der Kunde ansässig ist, bestimmt. Wenn die Ware in einem anderen Land vermarktet wird, liegt es in der Verantwortung des Kunden, die in diesem Land geltenden Vorschriften einschließlich Zoll- und Einfuhrbestimmungen sowie das Risiko von Streitigkeiten durch Dritte aus irgendeinem Grund zu überprüfen. Es versteht sich, dass Sambonet Paderno Industrie S.p.A. für jede mögliche Streitigkeit, die durch den Verkauf der Ware in diesem anderen Land entstehen kann, schadlos gehalten wird.
2. Sambonet Paderno Industrie S.p.A. übernimmt keine Garantie für eventuelle Ansprüche wegen Verletzung von gewerblichen Schutzrechten und Rechten des geistigen Eigentums Dritter, insbesondere im Falle des Weiterverkaufs der Ware über Internet.
3. Die Veröffentlichung von Preisen, die unter denen der geltenden Preislisten liegen, ist auf Webseiten ohne Authentisierung verboten.

Eigentumsverbehalt und Zahlungskonditionen

1. Eventuelle Beanstandungen können in keinem Fall den Aufschub oder die Unterbrechung der Zahlungen zur Folge haben.
2. Bei Zahlungsverzögerungen ist der Kunde im Übrigen gegenüber Sambonet Paderno Industrie S.p.A. rechtmäßiger Schuldner einer pauschalen Erstattung für Mahnaufwendungen, die sich auf € 40,00 beläuft. Wenn die Mahnaufwendungen den oben genannten Betrag überschreiten, hat Sambonet Paderno Industrie S.p.A. das Recht eine weitere Erstattung einzufordern.
3. Im Falle der Nichtzahlung des vollständigen oder teilweisen Rechnungsbetrags oder einer Verschlechterung der finanziellen Lage des Kunden hat Sambonet Paderno Industrie S.p.A. auch die Befugnis:
 - a) laufende Bestellungen und Lieferungen zu unterbrechen oder zu annullieren;
 - b) eine Vorauszahlung für weitere Bestellungen und/oder Zahlungsverpflichtungen zu verlangen.

Lieferung, Höhere Gewalt und übermäßige Hingabe

1. Die Liefertermine sind so genau wie möglich angegeben, hängen aber von den Materialbeschaffungs- und Transportbedingungen ab. Sambonet Paderno Industrie S.p.A. bemüht sich aufs Äußerste die Auslieferungstermine einzuhalten. Ausgenommen davon sind Fälle von höherer Gewalt.
2. Die Überschreitung der vorgesehenen Lieferzeiten verpflichtet Sambonet Paderno Industrie S.p.A. nicht zur Zahlung von Straf-, Schadensersatz- und Zinszahlungen.
3. Jede Änderung einer Bestellung hat eine Änderung des Liefertermins zur Folge.
4. Sambonet Paderno Industrie S.p.A. informiert den Kunden rechtzeitig über jede Art von Verspätung. In jedem Fall kann die vereinbarte Lieferung nur erfolgen, wenn der Kunde alle seine Verpflichtungen gegenüber Sambonet Paderno Industrie S.p.A. pünktlich erfüllt hat und zwar aus welchem Grund auch immer.
5. Sambonet Paderno Industrie S.p.A. wird nicht haftbar gemacht, wenn die verzögerte Erfüllung oder Nichterfüllung der vertraglichen Verpflichtungen auf Ursachen höherer Gewalt beruht, sofern die interessierte Partei nachweist: a) dass diese Behinderung außerhalb ihrer angemessenen Kontrolle liegt; b) dass diese Behinderung zum Zeitpunkt des Vertragsabschlusses vernünftigerweise nicht vorhersehbar war; und c) dass die Auswirkungen des Hindernisses vernünftigerweise nicht hätten vermieden oder überwunden werden können. Mangels gegenteiliger Beweise gelten als Ereignisse höherer Gewalt Krieg, Aufruhr, Handelsbeschränkungen, Embargo, Feuer, Zerstörung von Ausrüstung, Streiks, behördliche Maßnahmen, Einhaltung von Gesetzen oder behördlichen Anordnungen, sind aber nicht darauf beschränkt, Pest, Epidemie, Pandemie, Naturkatastrophe oder extremes Naturereignis. In solchen Fällen kann Sambonet Paderno Industrie S.p.A. die Erfüllung seiner vertraglichen Verpflichtungen aussetzen, indem er die andere Partei unverzüglich schriftlich benachrichtigt, und die Frist für die Ausführung der Lieferung kann um einen Zeitraum verlängert werden, der der Dauer des Ereignisses entspricht. Sofern nichts anderes schriftlich vereinbart wurde, gilt der Vertrag nach Ablauf der Aussetzungsfrist als fristlos gekündigt.
6. Sambonet Paderno Industrie S.p.A. kann den Vertrag auch kündigen, wenn die Erbringung der Leistung durch einen unvorhersehbaren und von ihm nicht zu vertretenden Umstand objektiv zu erschwerend wird.
7. Darüber hinaus wird zwischen den Parteien vereinbart, dass, wenn der Kunde die bestellten Produkte nicht zu den festgelegten Konditionen entgegennimmt, Sambonet Paderno Industrie S.p.A. dem Kunden:
 - a) jede weitere Ausgabe für Transport und/oder Einlagerung;
 - b) Aufbewahrungskosten in Höhe von 5% des Betrags der Bestellung, ausschließlich Steuer, für jeden Monat Verspätung in Rechnung stellt.

Wichtige Hinweise

1. Die Wahrnehmung von Farbe kann subjektiv sein und abhängig von der Geometrie, der Dimension, der Ausführung und der Beleuchtung eines Raums. Produkte, die dem PVD-Verfahren unterzogen werden, können kleine Farbvariationen oder Unterschiede bei verschiedenen Modellen, verschiedenen Referenzen oder Produktionschargen des gleichen Produkts aufweisen. Diese Farbabweichungen befinden sich im Rahmen eines im Voraus festgelegten Toleranzbereiches und werden streng überwacht.
2. Beim Druck kann es zu Fehlern und/oder Auslassungen kommen. Sambonet Paderno Industrie S.p.A. behält sich die Korrektur von Druck- oder Rechenfehlern vor.
3. Fotos und Abmessungen sind nur als Information zu verstehen. Wir behalten uns das Recht vor, die angegebenen Spezifikationen jederzeit zu ändern.
4. Das Profil der Bestecke ist nur als Informationskizze zu verstehen. Es stellt nicht dar die wirklichen Profile.

FRA

Conditions générales de Vente.

1. Toute commande envoyée du Client à Sambonet Paderno Industrie S.p.a est régie par les présentes CGV.
2. Sambonet Paderno Industrie S.p.A s'accorde le droit de modifier en tout moment ces conditions générales de vente en transmettant une communication écrite au Client.
3. En cas de litige, le Tribunal de Novara sera seul compétent. Seul le droit de la République italienne est applicable.
4. Les données personnelles fournies du client seront traitées dans le respect de la Règlementation UE n. 679/2016 et du décret législatif italien - décret législatif italien n. 196/2003.

Offres/ Commandes

1. Toute commande est soumise à l'acceptation de Sambonet Paderno Industrie S.p.A.
2. Le montant minimum de commande est de € 100,00 net HT.
3. Les offres de Sambonet Paderno Industrie S.p.A. sont libres et n'engagent pas à passer une commande.
4. L'acceptation d'une offre par écrit, ou la confirmation de la commande (et les manières qui sont contenu), sera réputée une véritable commande, qui entraîne l'exécution d'un contrat conforme aux termes et aux conditions générales de vente.
5. Emballage standard gratuit.
6. Les clients qui veulent profiter du statut de non-imposition, prévu par la loi italienne à l'article 8, comme 1, lett. c), du décret présidentiel n. 633/1972 (déclaration d'intention), devront le communiquer en même temps qu'ils enverront leur commande, afin que toutes les formalités administratives puissent être accomplies

Droit de propriété et conditions de paiement

1. Les marchandises fournies restent la propriété de Sambonet Paderno Industrie S.p.A. jusqu'au paiement intégral de la facture par le client.
2. La facture doit être réglée dans le délai préalablement convenu entre les parties. Tout retard de paiement entraînera l'application d'intérêts calculés au taux fixé par l'article 5 du décret législatif italien 231/2002 tel que modifié par le décret législatif italien 192/2012, majoré de 8%.

Retours/Réclamations

1. Les marchandises doivent être contrôlées à la réception.
2. En cas de colis défectueux / endommagés, le document de transport devra être signé sous réserve, en spécifiant les raisons (la photo du colis avec l'étiquette logistique et le ruban du transporteur bien en évidence, accompagnée de la description du défaut, vaut réserve).
3. Les réclamations doivent être soumises dans un délai maximum non négociable de 15 jours à compter de la date de la facture, aux conditions suivantes:
 - a) la réclamation / la demande de retour de marchandises doit être soumise en suivant la procédure assistée disponible à l'adresse www.agenti.sambonet.it dans l'espace utilisateur;
 - b) Tous les retours de marchandises sont départ notre usine;
 - c) en cas de responsabilité du client, Sambonet Paderno Industrie S.p.A. facturera 15% du prix net, avec un montant minimum de € 25,00, pour les frais de gestion;
 - d) en cas de responsabilité avérée de Sambonet Paderno Industrie S.p.A., les marchandises seront remplacées et retournées franco domicile client;
 - e) pour les produits retournés pour réparation hors garantie, les frais de transport aller-retour sont à la charge du client;
 - f) les retours d'articles spéciaux (hors catalogue), personnalisés ou hors production ne sont pas acceptés.

Annulation des commandes

1. Les commandes de produits hors catalogue, personnalisés ou spéciaux ne peuvent pas être annulées.
2. Les commandes de produits sur catalogue ne peuvent être annulées que si la commande n'a pas encore été confirmée.

Conditions de livraison – Groupe A

Autriche, Allemagne, Pays-Bas, Belgique, Luxembourg, France, Royaume-Uni:

1. Les envois de marchandises sont franco domicile client:
 - a) avec € 15,00 à la charge du client pour tout montant net HT de commande de € 100,00 à € 350,00;
 - b) sans aucune charge pour tout montant net HT de commande supérieur à € 350,00.
2. Les conditions susmentionnées ne sont valables que pour les envois effectués par le transporteur conventionné avec Sambonet Paderno Industrie S.p.A.

Conditions de livraison – Groupe B

Espagne, Portugal, Pologne, République tchèque, Slovaquie, Hongrie, Roumanie, Slovaquie, Croatie, Bulgarie, Danemark, Norvège:

1. Les envois de marchandises sont franco domicile client:
 - a) avec € 30,00 à la charge du client pour tout montant net HT de commande de € 100,00 à € 600,00;
 - b) sans aucune charge pour tout montant net HT de commande supérieur à € 600,00.
2. Les conditions susmentionnées ne sont valables que pour les envois effectués par le transporteur conventionné avec Sambonet Paderno Industrie S.p.A.

Conditions de livraison – Groupe C

Grèce, Irlande, Lettonie, Lituanie, Estonie, Suède, Finlande:

1. Les envois de marchandises sont franco domicile client:
 - a) avec € 50,00 à la charge du client pour tout montant net HT de commande de € 100,00 à € 1.000,00;
 - b) sans aucune charge pour tout montant net HT de commande supérieur à € 1.000,00.
2. Les conditions susmentionnées ne sont valables que pour les envois effectués par le transporteur conventionné avec Sambonet Paderno Industrie S.p.A.

Conditions de livraison – Groupe D

Pays de l'UE et extra-UE non spécifiés dans les paragraphes précédent:

1. Tous les envois de marchandises sont départ usine.

Produits personnalisés (les prix indiqués sont nets)

1. Sambonet Paderno Industrie S.p.A. est en mesure de réaliser des produits personnalisés à la demande du client aux conditions suivantes:
 - a) paiement d'un acompte de 30% sur le montant de la commande;
 - b) livraison à convenir après l'approbation du dessin exécutif et/ou de l'échantillon;
 - c) Sambonet Paderno Industrie S.p.A. se réserve le droit d'appliquer à chaque référence une tolérance de livraison sur les quantités commandées de +/- 10% arrondie à l'unité supérieure;
 - d) Sambonet Paderno Industrie S.p.A. enverra au client une fiche avec toutes les données techniques nécessaires (dessin, position, dimensions, etc.) et n'exécutera la commande qu'à la réception de la fiche signée pour autorisation.
2. Couteaux à dessert exécutés avec lame dentelée (si cette lame n'est pas la lame standard): € 0,65 par pièce.
3. Gravure pantographe/laser:
 - a) frais de commande: € 70,00;
 - b) frais de gravure: couverts € 0,50 par pièce - plats et articles de table, si gravure faisable, € 1,00 par pièce;
 - c) quantité minimum de commande: couverts 100 pièces pour chaque référence - plats et articles de table 10 pièces pour chaque référence.
4. Poinçonnage:
 - a) frais de poinçon: € 300,00 pour le premier poinçon - € 150,00 pour chaque poinçon supplémentaire;
 - b) frais de poinçonnage: couverts € 0,50 par pièce - plats et articles de table: devis sur demande;
 - c) quantité minimum de commande:
 - première commande: couverts 1.000 pièces par référence - couteaux poignée creuse 800 pièces par référence;
 - commandes suivantes: couverts 100 pièces par référence - couteaux poignée creuse 800 pièces par référence.

Personnalisations Sambonet Tailor Made (Les prix indiqués sont nets)

1. Types de gravures Tailor Made standard :
 - a) Au recto du manche : un des logos standard ou un monogramme (deux lettres) en utilisant l'une des polices standard ;
 - b) Au verso du manche : la date au format standard en utilisant l'une des polices standard ;
2. Coût de la gravure Tailor Made :
 - a) 19,90 € pour les gravures au recto du manche ;
 - b) 19,90 € pour les gravures au verso du manche ;
 - c) 39,80 € pour les gravures au recto et au verso du manche.
3. Minimum d'achat pour des articles en vrac Tailor Made :
 - a) 6 pièces pour les références en maillehort, par multiple de 6 pièces ;
 - b) 12 pièces pour toutes les autres références, par multiple de 12 pièces ;
4. Application du coût de la gravure Tailor Made sur chaque commande :
 - a) Un coût unique pour chaque type de gravure – indiqués au point 2 ;
 - b) Un coût unique quel que soit le nombre de références – à condition qu'il soit supérieur au minimum d'achat indiqué au point 3 ;
 - c) Un coût unique quel que soit le nombre de pièces jusqu'à 150 pièces.
- d) Au-delà de 150 pièces et par multiple de 150 pièces, le coût de la gravure sera à nouveau appliqué.

Conditions spéciales pour les personnalisations

1. L'entreprise se réserve le droit de ne pas procéder à la personnalisation pour des raisons de faisabilité technique.
2. Les commandes de produits personnalisés e/o spéciaux ne peuvent pas être annulées.
3. Les produits personnalisés ne peuvent pas être retournés pour remplacement.
4. Les frais de préparation de commandes personnalisées (tels que l'étiquetage, l'emballage, la palettisation et/ou toute autre exigence non standard) sont à la charge du Client. Pour les conditions, les coûts et les détails spécifiques, veuillez vous référer au document de l'entreprise "Charte des services".

Commercialisation

1. Les produits sont destinés à la commercialisation dans le Pays où le client est basé. Si les produits sont vendus dans un autre Pays, il est de la responsabilité du client de vérifier les réglementations applicables dans ce Pays, y compris les réglementations douanières et d'importation, ainsi que le risque de litiges par des tiers pour quelque motif que ce soit, étant entendu que Sambonet Paderno Industrie S.p.A. sera déchargé de tout litige qui pourrait survenir dans ce Pays différent.
2. Sambonet Paderno Industrie S.p.A. ne fournit aucune garantie quant à d'éventuelles actions pour violation des droits de propriété industrielle et intellectuelle par des tiers, en particulier en cas de revente du produit sur Internet.
3. Il est interdit de publier des prix inférieurs aux tarifs en vigueur sur des sites Web sans authentification.

Réserve de propriété et conditions de paiement

1. Toute réclamation du Client ne peut en aucun cas avoir pour effet de différer ou de suspendre le paiement.
2. En cas de retard de paiement, le Client est redevable de plein droit, envers Sambonet Paderno Industrie S.p.A., d'une indemnité forfaitaire de 40,00 € pour frais de recouvrement. Si les frais de recouvrement sont supérieurs à ce montant, Sambonet Paderno Industrie S.p.A. est en droit de réclamer une indemnisation complémentaire.
3. En cas de non-paiement de tout ou partie de la facture, ou en cas de dégradation de la situation financière du Client, Sambonet Paderno Industrie S.p.A. a également le droit de :
 - a) suspendre ou annuler toute commande et livraison en cours ;
 - b) exiger un acompte pour toute nouvelle commande et/ou des garanties de paiement.

Livraison. Cas de force majeure et Surcharge excessive

1. Les délais de livraison sont indiqués aussi exactement que possible, mais sont fonction des possibilités d'approvisionnement et de transport de Sambonet Paderno Industrie S.p.A., qui s'engage à respecter les délais de livraison avec la plus grande rigueur sauf cas de force majeure.
2. Les dépassements de délai de livraison ne peuvent donner lieu au paiement de pénalités et de dommages-intérêts par Sambonet Paderno Industrie S.p.A.
3. Toute modification de la commande entraînera une modification de la date de livraison.
4. Sambonet Paderno Industrie S.p.A. s'engage à informer le Client sans délai de tout retard. En toute hypothèse, la livraison dans les délais ne peut intervenir que si le Client est à jour de ses obligations envers Sambonet Paderno Industrie S.p.A., quelle qu'en soit la cause.
5. Sambonet Paderno Industrie S.p.A. ne sera pas considérée responsable en cas de retard ou du non-respect des obligations contractuelles en présence de situations considérées comme cas de Force Majeure, si le vendeur démontrera: a) que cet accident est tout à fait hors de son possible contrôle ; b) qu'il ne pouvait absolument pas prévoir ces conditions au moment de l'accord contractuel ; c) que les effets et les résultats de cet événement exceptionnel donnant lieu au problème ne pouvaient pas être évités ni échappés. En l'absence de preuve contraire, on considère comme cas de force majeure et à titre d'exemple tous les événements tels que la guerre, l'émeute, les restrictions commerciales, l'embargo, l'incendie, la perte ou la destruction des outillages, les grèves, toute décision des autorités par rapport à l'approbation d'une loi ou tout acte du Gouvernement, la peste, l'épidémie, la pandémie, toute calamité naturelle ou tout événement naturel extrême. Dans ces cas, Sambonet Paderno Industrie S.p.A. pourra ne pas remplir ses obligations contractuelles, en transmettant une communication écrite au client et les termes et les délais d'exécution de la commande seront prolongés pour toute la durée de cet événement. Sauf accord différent entre le Vendeur et le client, une fois dépassée cette période de suspension, le contrat sera considéré comme annulé sans besoin d'ultérieur préavis ou communication.
6. Sambonet Paderno Industrie S.p.A. peut également résilier le contrat si l'exécution est objectivement trop onéreuse par une circonstance imprévisible et indépendante de sa volonté.
7. Les parties conviennent également que si le Client ne prend pas possession des produits commandés selon les conditions fixées, Sambonet Paderno Industrie S.p.A. lui facturera :
 - a) les frais supplémentaires de transport et/ou de stockage ;
 - b) les frais de garde équivalents à 5 % du montant de la commande, hors taxes, pour chaque mois de retard.

Avertissements importants

1. La perception de la couleur peut être subjective en fonction de la géométrie, des dimensions, des finitions et de l'éclairage du local. Les produits soumis à un traitement PVD pourraient subir de petites variations chromatiques ou des discontinuités parmi des modèles, des références ou des lots différents du même produit. Ces variations sont comprises dans les limites de tolérance préétablies et strictement surveillées.
2. Des fautes et/ou des omissions peuvent survenir lors de l'impression. Sambonet Paderno Industrie S.p.A. se réserve le droit de corriger toute faute d'impression ou de calcul.
3. Les photos et dimensions indiquées sont indicatives. Sambonet Paderno Industrie S.p.A. se réserve le droit de modifier à tout moment les spécifications techniques.
4. Les silhouettes des couverts de ce tarif sont uniquement indicatives et elles ne se réfèrent pas à la silhouette réelle des couverts.

Condiciones generales y de venta

- Las presentes Condiciones Generales de Venta se aplican a cualquier pedido que el Cliente envíe a Sambonet Paderno Industrie.
- Sambonet Paderno Industrie S.p.A se reserva el derecho incuestionable de modificar las presentes Condiciones Generales en cualquier momento, notificándolo por escrito al Cliente.
- En caso de disputa, el Tribunal de Novara será el único competente. Se aplicará exclusivamente la ley de la República Italiana.
- Los datos personales proporcionados por el Cliente se procesarán de conformidad con el Reglamento UE n.º 679/2016 y el Decreto Legislativo n.º 196/2003.

Ofertas/Pedidos

- Los pedidos deben ser aprobados por Sambonet Paderno Industrie S.p.A.
- Pedido mínimo de € 100,00 en factura.
- Las ofertas de Sambonet Paderno Industrie S.p.A. son libres y no vinculantes al pedido.
- Aceptando por escrito la oferta, o la confirmación del pedido (con las modalidades en ella incluidas) se produce a todos los efectos un pedido que implica un contrato conforme a las condiciones generales y de venta.
- Embalaje estándar incluido.
- Los clientes que pretendan acogerse a la no sujeción al impuesto en virtud del artículo 8, apartado 1, letra c), del Decreto Presidencial n.º 633/1972 (declaración de intenciones), deberán notificarlo en el momento del envío del pedido, con el fin de permitir la realización de los trámites administrativos necesarios.

Derecho de propiedad y condiciones de pago

- La mercancía queda de propiedad de Sambonet Paderno Industrie S.p.A. hasta que el cliente haga el pago total de la factura.
- El plazo de pago de la factura tiene que sea realizado dentro de los términos establecidos previamente por las partes. Al caducar dicho plazo, deberán considerarse los intereses de demora según lo dispuesto por el art. 5 D.LGS 231/2002 y siguientes modificaciones, como previsto en el D.LGS. 192/2012, con aumento del 8%.

Restituciones/Reclamaciones

- La mercancía debe controlarse en el momento de la entrega. (tiene que sea controlada)
- En caso de embalajes defectuosos/deteriorados, el documento de transporte se deberá firmar (tiene que sea firmado) bajo reserva especificando las razones (como reserva se debe presentar la foto del embalaje y su código de barra, la cinta del servicio de transporte y la descripción de la avería).
- Las reclamaciones se aceptarán dentro de 15 días a partir de la fecha de emisión de la factura, plazo no negociable, bajo las condiciones que se citan a continuación:
 - La reclamación/solicitud de restitución de mercancía debe realizarse a través del procedimiento guiado en la página web: www.agenti.sambonet.it en el área de usuarios;
 - La mercancía se entrega franco nuestra fábrica;
 - En caso de que el cliente sea responsable, Sambonet Paderno Industrie S.p.A. le cargará el 15% del precio neto, con un mínimo de € 25,00 de coste de gestión;
 - En caso de responsabilidad comprobada de Sambonet Paderno Industrie S.p.A., la mercancía será reemplazada y entregada al cliente con porte pagado;
 - los gastos de transporte para la reparación de productos sin garantía, corren a cargo del cliente;
 - para los artículos especiales (no incluidos en el catálogo), personalizados o fuera de producción no será posible restituir la mercancía.

Cancelación del pedido

- para los productos no incluidos en el catálogo, personalizados o especiales NO es posible cancelar el pedido.
- para los productos incluidos en el catálogo, es posible cancelar el pedido sólo en caso de que aún no haya sido confirmado.

Condiciones de entrega – Grupo A

Austria, Alemania, Holanda, Bélgica, Luxemburgo, Francia, Reino Unido:

- La mercancía se remite a porte pagado:
 - cargando € 15,00 para pedidos de entre € 100,00 y € 350,00 netos;
 - sin cargo alguno si el pedido neto sobrepasa los € 350,00.
- Las condiciones mencionadas arriba deben considerarse válidas sólo para los servicios de transporte elegidos por Sambonet Paderno Industrie S.p.A.

Condiciones de entrega – Grupo B

España, Portugal, Polonia, República Checa, Eslovaquia, Hungría, Rumania, Eslovenia, Croacia, Bulgaria, Dinamarca, Noruega:

- La mercancía se remite a porte pagado:
 - cargando € 30,00 para pedidos de entre € 100,00 y € 600,00 netos;
 - sin cargo alguno si el pedido neto sobrepasa los € 600,00.
- Las condiciones mencionadas arriba deben considerarse válidas sólo para los servicios de transporte elegidos por Sambonet Paderno Industrie S.p.A.

Condiciones de entrega – Grupo C

Grecia, Irlanda, Letonia, Lituania, Estonia, Suecia, Finlandia:

- La mercancía se remite a porte pagado:
 - cargando € 50,00 para pedidos de entre € 100,00 y € 1.000,00 netos;
 - sin cargo alguno si el pedido neto sobrepasa los € 1.000,00.
- Las condiciones mencionadas arriba deben considerarse válidas sólo para los servicios de transporte elegidos por Sambonet Paderno Industrie S.p.A.

Condiciones de entrega – Grupo D

Países de la UE y países extra-UE no especificados en los párrafos anteriores:

- La mercancía se entrega franco fábrica.

Personalizaciones (Los precios indicados deben considerarse netos)

- Bajo solicitud del cliente, Sambonet Paderno Industrie S.p.A. realiza personalizaciones y acabados particulares según las siguientes condiciones:
 - pago de un anticipo del 30% del valor del pedido;
 - La entrega será establecida tras aprobar el diseño ejecutivo y/o la muestra;
 - Sambonet Paderno Industrie S.p.A. se reserva el derecho de aplicar, en cada artículo, una tolerancia del +/- 10%, redondeando por exceso, para el envío de las cantidades solicitadas;
 - Sambonet Paderno Industrie S.p.A. enviará al cliente una ficha con toda la información necesaria (diseño, posición, medidas, ecc). La entrega se efectuará sólo después de haber recibido la ficha firmada por el cliente.
- Endentado de hojas cuchillos postre: si no previsto de serie, con cargo de € 0,65 / pieza.
- Grabado por Pantógrafo/Láser:
 - coste instalación: € 70,00;
 - coste grabado: cubiertos € 0,50 / pieza – vajilla, grabado (si es posible) € 1,00 / pieza;
 - cantidades mínimas. Cubiertos: 100 piezas por modelo - vajilla: 10 piezas por modelo.
- Punzonado:
 - coste punzones: € 300,00 para el primer punzón - € 150,00 para los siguientes (cada uno);
 - coste punzonado: cubiertos € 0,50 / pieza - vajilla: solicitando un presupuesto;
 - pedidos mínimos:
 - nuevas instalaciones. Cubiertos: 1.000 piezas por modelo - cuchillos de mango hueco: 800 piezas por modelo;
 - pedidos adicionales. Cubiertos: 100 piezas por modelo - cuchillos de mango hueco: 800 piezas por modelo.

Personalizaciones Sambonet Tailor Made (Los costes indicados son netos)

- Tipos de grabados Tailor Made estándar:
 - En el terminal frontal: uno de los logotipos estándar, o el monograma (dos letras) usando uno de los caracteres estándar;
 - En el terminal trasero: la fecha en formato estándar, utilizando uno de los caracteres estándar;
- Coste de grabado Tailor Made:
 - € 19,90 para grabados en el terminal frontal;
 - € 19,90 para grabados en el terminal trasero;
 - € 39,80 para grabados en el terminal delantero y en el terminal trasero.
- Pedido mínimo de compra para artículos sueltos Tailor Made:
 - 6 pzas para las referencias hechas en alpaca, con múltiples de 6 pzas;
 - 12 pzas para todas las otras referencias, con múltiples de 12 pzas;
- Aplicación del coste de grabado Tailor Made en un único pedido de compra:
 - Un solo coste para cada tipo de grabado - indicados en el punto 2;
 - Un solo coste independientemente del número de referencias - si superiores al mínimo de compra indicado en el punto 3;
 - Un solo coste independientemente del número de piezas hasta 150 pzas.
 - Con más de 150 piezas y múltiples de 150 piezas se aplicará otra vez el coste de grabado.

Condiciones especiales para las personalizaciones

- La Empresa se reserva el derecho de no llevar a cabo la personalización si no fuera técnicamente realizable.
- Pedidos personalizados y/o acabados particulares no se pueden cancelar.
- No se pueden devolver, para su reemplazo, los productos personalizados.
- Los costes de preparación de pedidos personalizados (como el etiquetado, el embalaje, la paletización y/o cualquier otro requisito no estándar) correrán a cargo del Cliente. Para conocer las condiciones, los costes y los detalles específicos, consulte el documento de la empresa "Carta de Servicios".

Comercialización

- Los productos están destinados a la comercialización en el País donde se encuentra el cliente. Si los productos se comercializan en un País diferente, será responsabilidad del cliente verificar las regulaciones aplicables en ese País, incluidas las regulaciones de aduanas e importación, así como el riesgo de disputas por parte de terceros por cualquier motivo, entendiéndose que Sambonet Paderno Industrie SpA estará libre de cualquier disputa que pueda surgir en este País diferente.
- Sambonet Paderno Industrie S.p.A. no ofrece ninguna garantía con respecto a posibles reclamos de violación de derechos de propiedad industrial e intelectual de terceros, en particular en el caso de reventa de los productos a través de Internet.
- Está prohibido publicar precios inferiores a las listas de precios vigentes en sitios web sin autenticación.

Reserva de propiedad y condiciones de pago

- Cualquier reclamación no podrá, en ningún caso, tener como efecto el retraso o la suspensión de los pagos.
- Además, en situaciones de retraso en el pago, el Cliente será deudor de derecho, para con Sambonet Paderno Industrie S.p.A. de una indemnización a tanto alzado por los gastos de requerimiento igual a € 40,00. Si los gastos de requerimiento son más altos que la cantidad mencionada anteriormente, Sambonet Paderno Industrie S.p.A. tendrá derecho a solicitar una compensación adicional.
- En caso de falta de pago de toda o parte de la factura, o de empeoramiento de la situación financiera del Cliente, Sambonet Paderno Industrie S.p.A. también tendrá el derecho de:
 - suspender o cancelar los pedidos y las entregas en curso;
 - exigir un pago por adelantado para los pedidos y/o garantías de pago sucesivos.

Entrega, Fuerza mayor y Excesiva onerosidad sobrevenida

- Los plazos de entrega se indican lo más exactamente posible, pero dependen de las condiciones de abastecimiento y transporte de Sambonet Paderno Industrie S.p.A., que se compromete a poner la máxima diligencia para cumplir con las entregas, excepto en casos de fuerza mayor.
- Exceder los tiempos de entrega previstos no puede vincular Sambonet Paderno Industrie S.p.A. al pago de sanciones o indemnizaciones por daños e intereses.
- Cualquier modificación del pedido dará lugar a una consecuente modificación de la fecha de entrega.
- Sambonet Paderno Industrie S.p.A. informará al Cliente de forma tempestiva sobre cualquier retraso. En cualquier caso, la entrega dentro de los plazos solo se puede realizar si el Cliente ha cumplido debidamente con todas sus obligaciones para con Sambonet Paderno Industrie S.p.A., cualquiera sea la causa.
- Sambonet Paderno Industrie spa no es responsable de cualquier tardanza o falta de ejecución de las obligaciones contractuales que son de fuerza mayor, en la medida que la parte interesada demuestre:
 - que tal impedimento sucedió fuera de su control.
 - que no podía razonablemente ser previsto al momento de la conclusión del contrato.
 - que los efectos de este impedimento non han podido ser evitados o superados. En ausencia de pruebas contrarias, se se consideran eventos de fuerza mayor a título ejemplificativo: guerra, revuelta, restricciones comerciales, embargo, incendio, destrucción de equipos, huelgas, acto de autoridad legal, respeto a cualquier ley o orden gubernativo, peste, epidemia, pandemia, calamidad natural u otro evento natural extremo. En tal caso Sambonet Paderno Industrie spa, podrá suspender /adempimiento de los obligos contractuales dando inmediato aviso por escrito a la parte interesada, y el termine de ejecución de la venta podrá ser prorrogado por un periodo igual del evento en sí. Salvo diversos acuerdos por escrito, o decorrenza inutil en el periodo de suspensión, el contrato se entendera como anulado sin ulterior aviso.
- Sambonet Paderno Industrie SPA podrá, además, resolver el contrato si la ejecución de las prestaciones son objetivamente mas caras de la circunstancia imprevedible independientemente de su voluntad.
- También se acuerda entre las partes que si el Cliente no toma posesión de los productos pedidos bajo las condiciones establecidas, Sambonet Paderno Industrie S.p.A. facturará al Cliente:
 - cualquier costo adicional de transporte y/o almacenamiento;
 - gastos de custodia equivalentes al 5% del monto del pedido, excluidos los impuestos, para cada mes de retraso.

Advertencias importantes

- La percepción del color puede ser subjetiva en función de la geometría, el tamaño, los acabados y la iluminación del entorno. Los productos sometidos al proceso PVD podrían estar sujetos a pequeñas variaciones cromáticas o discontinuidades entre diferentes modelos, entre diferentes referencias o entre partes diferentes del mismo producto. Dichas variaciones están comprendidas dentro de límites de tolerancia preestablecidos y estrictamente monitoreados.
- Al imprimir puede ser que surjan errores y/o omisiones. Sambonet Paderno Industrie S.p.A. se reserva el derecho a rectificar eventuales errores de impresión o de cálculo.
- Fotos, datos y medidas que aparecen en este catálogo son indicativos y susceptibles, sin previo aviso, de modificación.
- Los perfiles de los cubiertos de la lista de precios son meramente simbólicos y no corresponden a los perfiles reales.

CREDITS

PHOTO

Riccardo Bianchi
Felice Scoccimarro

LOCATIONS

Cucine Nervi - Gattinara (NO)

COVER

Paolo Oberti - Sous Chef di Cucine Nervi



ARCTURUS GROUP

© COPYRIGHT

- Ogni riproduzione anche parziale del presente catalogo è vietata se non espressamente autorizzata per iscritto da Sambonet Paderno Industrie S.p.A.
- This catalogue may not be reproduced in whole or in part unless specific prior written authorization of Sambonet Paderno Industrie S.p.A.
- Die Vervielfältigung dieses Katalogs -auch wenn partial- ohne unsere ausdrückliche schriftliche Erlaubnis ist untersagt.
- Toute reproduction ou reproduction partielle de ce catalogue est interdite sauf expressément autorisée par Sambonet Paderno Industrie S.p.A.
- Queda prohibida la reproducción total o parcial de este catálogo sin autorización de forma expresa y por escrito de Sambonet Paderno Industrie S.p.A.

NOTE - NOTES

- Le misure, caratteristiche ed illustrazioni dei prodotti sono indicative e soggette a variazioni senza preavviso qualora esigenze tecnico produttive lo richiedessero.
- The pictures illustrated and data are representatives. We reserve the right to alter at any time the specifications stated without notice, whenever technical requirements shall so demand.
- Fotos und Abmessungen sind nur als information zu verstehen. Wir behalten uns das Recht vor, die angegebenen Spezifikationen jederzeit zu ändern, sofern es aus produktionstechnischen Gründen erforderlich ist.
- Les photos et dimensions indiquées sont indicatives. Nous nous réservons le droit de modifier à tout moment les spécifications techniques, si la situation l'exige.
- Fotos, datos y medidas que aparecen en este catálogo son indicativos y susceptibles, sin previo aviso, de modificación por exigencias técnicas o de producción.



www.paderno.it

SAMBONET PADERNO INDUSTRIE S.P.A.

Via Giovanni Coppo, 1C - 28060 Orfengo (NO) - Italy

horeca@paderno.it

horeca@sambonet.it

Ph. +39 0321 1916 601

Fax +39 0321 1916 890

retail.italia@sambonet.it

retail.international@sambonet.it

Ph. +39 0321 1916 701

Fax +39 0321 1916 830

www.paderno.it

ROSENTHAL SAMBONET USA LTD.

685 Route 10 - Randolph NJ 07869 - USA

Ph. +1 201 804 8000

Fax +1 201 842 9195

info@rosenthalusa.com

www.rosenthal-hotel-restaurant.com



ARCTURUS GROUP

XE2344 - Ed. 10/2023

